

MODEL: WMTS-100

TRIPOD ROOF KIT

- Do Not Over Tighten Fasteners
- Do Not Leave Out or Use in High Winds

Instruction and Safety Manual

**FOR USE WITH
AMERISTEP'S 15' TRIPOD
MODEL# WMTS-15R**



*Tripod Sold Separately

⚠ Warning

Every year serious injury and even death occurs from hunting related falls. To ensure your safety, please **COMPLETELY** read and follow this safety manual and **ALL** warning labels **BEFORE** assembling, installing or utilizing this product.

Follow WMTS-15R Tripod Instructions for Tripod Setup.

DO NOT USE THIS PRODUCT IN HIGH WINDS OR OTHER INCLEMENT WEATHER. DO NOT USE THIS PRODUCT BEFORE FULLY UNDERSTANDING ALL SAFETY WARNINGS AND INSTRUCTIONS. IF YOU HAVE QUESTIONS, ARE UNSURE ABOUT ANY INFORMATION OR NEED ADDITIONAL INFORMATION CONCERNING YOUR PRODUCT, CONTACT OUR CUSTOMER SERVICE DEPARTMENT AT 1-866-972-6168 OR VISIT WWW.TREESTANDCUSTOMERSERVICE.COM. KEEP AND MAINTAIN THIS SAFETY AND INSTRUCTION MANUAL IN A SAFE LOCATION FOR FUTURE REFERENCE.

MODEL: WMTS-100

TRIPOD ROOF KIT

- Do Not Over Tighten Fasteners
- Do Not Leave Out or Use in High Winds

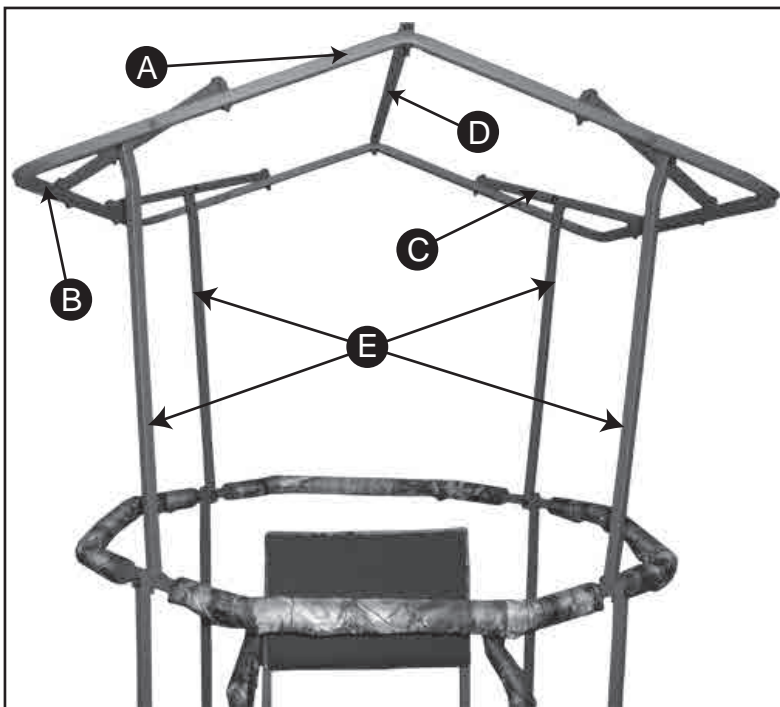
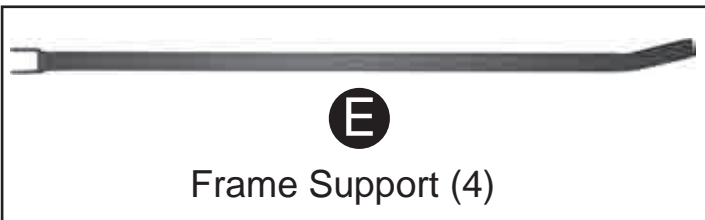
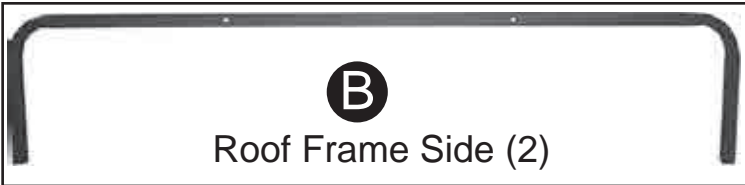
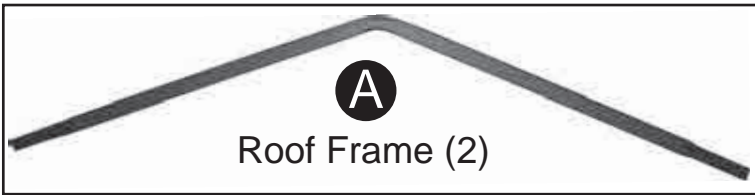

*Roof Cover Not Shown to Show Details

PARTS LIST

- A** 2 Roof Frame.....Part # WRF-100
- B** 2 Roof Frame Side.....Part # WFS-100
- C** 4 Frame Brace.....Part # WFB-100
- D** 1 Roof Top.....Part # WRT-100
- E** 4 Frame Supports.....Part # WFS-100
- F** 1 Roof Cover.....Part # WRC-100

HARDWARE

- (50)** 14 M10x50mm Bolt.....Part # 1055



F
Roof Cover (1)

⚠ WARNING

You MUST use a Hoist system to lift the Roof to the Stand for installation
DO NOT climb the Ladder with the Roof in Hand

⚠ WARNING

NEVER stand on seat platform to attach roof.

⚠ WARNING

DO NOT use this product in high winds or other inclement weather.

⚠ WARNING

Follow WMTS-15R Tripod Instructions for Tripod Set-Up

Tools Required
Adjustable Wrench



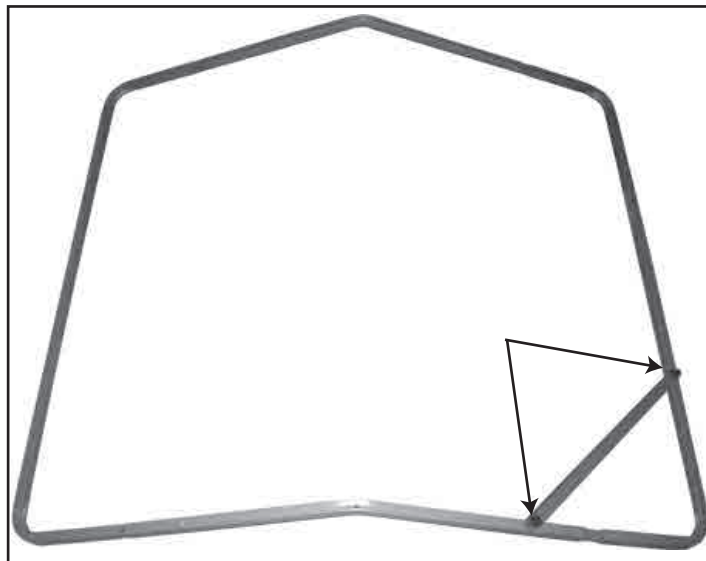
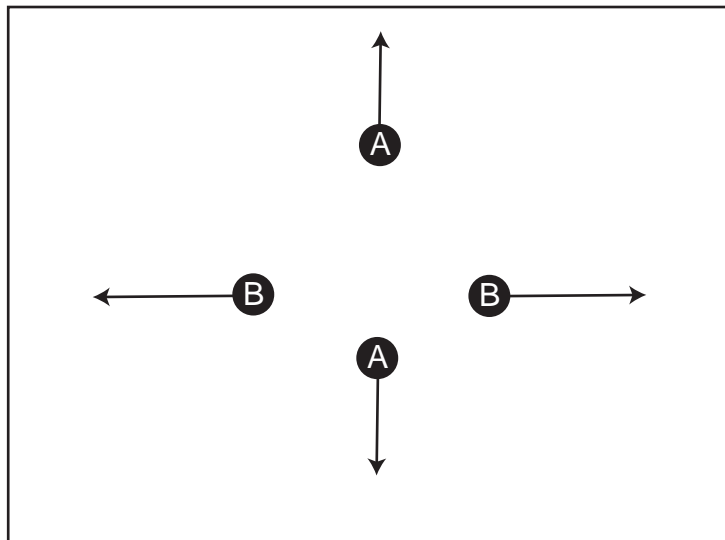

1. Insert each Roof Frame **A** into each Roof Frame Side **B**.

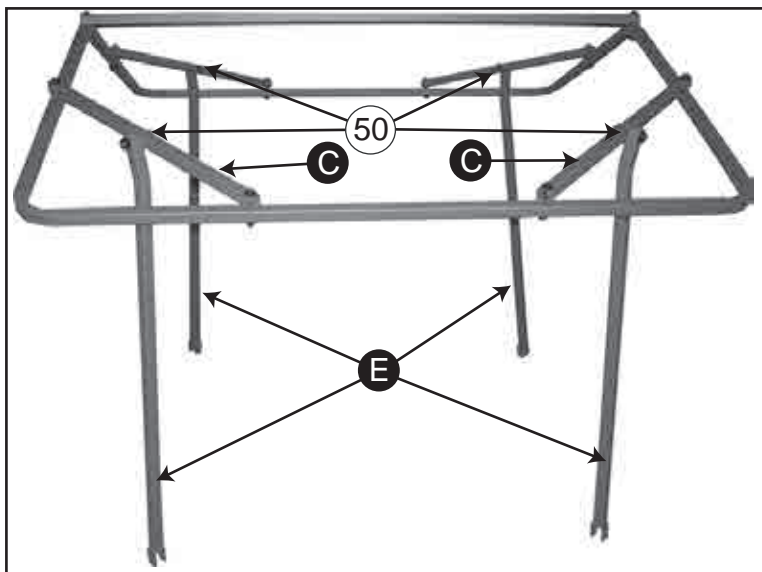

⚠ WARNING
You **MUST** use a Hoist system to lift the Roof to the Stand for installation
DO NOT climb the Ladder with the Roof in Hand

⚠ WARNING
NEVER stand on seat platform to attach roof.

5. Attach each Frame Support **E** to the center of each Frame Brace **C** using **1-M10x50mm Bolt**. Make sure that the curved end of the Frame Supports are facing outward.

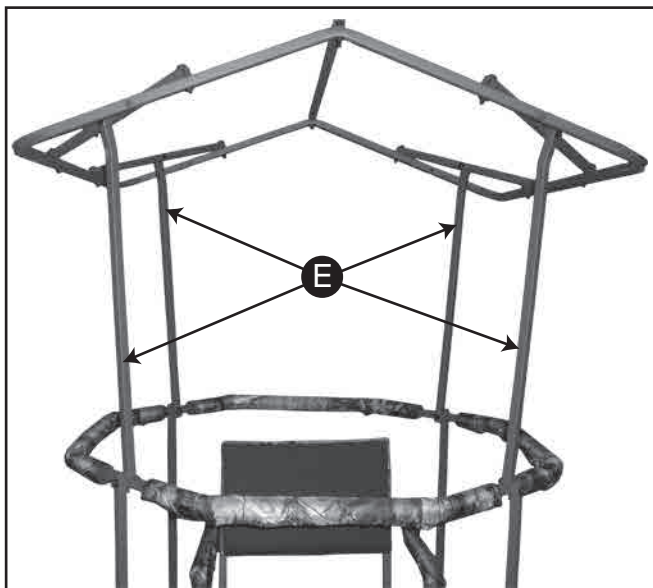

6. Attach each Frame Support **E** to where the Shooting Rail is attached to the Tripod using the same bolts. The brackets on the Frame Supports will fit over the Shooting Rail.
Remove the bolts holding the shooting rail on the tripod one at a time.
Make sure that the peak of the roof kit is over the ladder. This will allow easier access to the seat.

7. Attach Roof Cover **F** on top of the assembled Roof Kit. Make sure that the peaks of the roof Cover match up with the Peaks of the Roof Frames. Tie off where provided.

⚠ WARNING
Follow WMTS-15R Tripod Instructions for Tripod Set-Up

⚠ WARNING
DO NOT use this product in high winds or other inclement weather.

Hunting For Low Prices?

These Items
Now Available at
Walmart and Walmart.com



20' STICK LADDER



HANG-ON TREESTAND



BONE COLLECTOR HANG-ON TREESTAND



CLIMBER

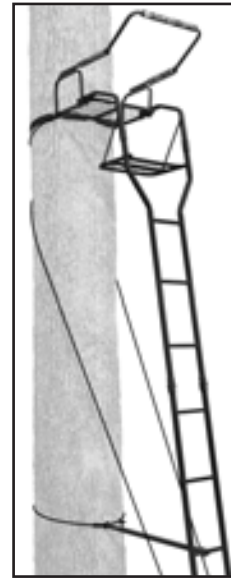

16' RECON LADDERSTAND



15' TWO-MAN LADDERSTAND

Check Out Walmart.com For Even More Tree Stands and Accessories



STEEL RAPID RAILS



BONE COLLECTOR AVENGER ALUMINUM HANG-ON TREESTAND



15' TRIPOD



TRIPOD ROOF KIT