

MODEL: WMSL-125

20' STICK LADDER

- Always Wear a Safety Harness with this Product
- Practice Using at Ground Level
- Weight Limit: 300 lbs.
- Tree Size: 9"-18" diameter



Instruction and Safety Manual

⚠ Warning

Every year serious injury and even death occurs from hunting related falls. To ensure your safety, please **COMPLETELY** read and follow this safety manual and ALL warning labels **BEFORE** assembling, installing or utilizing this product.

DO NOT USE THIS PRODUCT BEFORE FULLY UNDERSTANDING ALL SAFETY WARNINGS AND INSTRUCTIONS. IF YOU HAVE QUESTIONS, ARE UNSURE ABOUT ANY INFORMATION OR NEED ADDITIONAL INFORMATION CONCERNING YOUR PRODUCT, CONTACT OUR CUSTOMER SERVICE DEPARTMENT AT 1-866-972-6168 OR VISIT WWW.TREESTANDCUSTOMERSERVICE.COM. KEEP AND MAINTAIN THIS SAFETY AND INSTRUCTION MANUAL IN A SAFE LOCATION FOR FUTURE REFERENCE.

TREESTAND SAFETY WARNINGS

Please read the following instruction manual and warnings labels completely before utilizing this product. Failure to understand and execute the instructions and warnings may result in serious injury or death. In the event of an accident, have a plan for rescue, including the use of devices that may be easily reached while suspended.

ALWAYS read and understand all warnings and instructions. Watch a "Safe Hunting" DVD that you would have received with your tree stand in its entirety before doing anything with this product including assembly, installation etc. before each use of this product. Failure to read and understand all warnings and instructions and DVD material may result in serious injury or death. Contact a Customer Service Representative with any questions you may have.

NEVER exceed total weight limit of **300 lbs.** **DO NOT** use if your combined weight with all of your hunting gear and any accessories exceeds **300 lbs.** Use of tree stand over the weight limit may result in serious injury or death.

DO NOT use this tree stand while under the influence of alcohol, medication or any illegal substances. Use of tree stand while under the influence of any of these substances may result in serious injury or death.

NEVER use this tree stand during inclement weather. **DO NOT** use tree stand during thunderstorms, snowstorms, hurricanes, tornadoes or any other weather conditions that include (but not limited to) lightning, icy conditions, or high winds that could create slippery or dangerous situations. End your hunt and return to the ground if inclement weather conditions arise.

NEVER use tree stand if you are feeling ill, nauseous, dizzy or if you have a prior condition that could cause a problem. i.e., heart condition, joints that lock-up spinal fusions, etc., or if you are not well rested and alert. Physical ailments can reduce your ability to safely install, utilize, and remove your tree stand. Please consult a physician prior to use.

NEVER use this tree stand if you have a history of health problems such as (but not limited to) heart problems, back problems, high blood pressure, impaired vision, equilibrium impairments, are afraid of heights, have been advised by a doctor or physician not to climb. If you are not physically fit, well rested, and alert, or if you have any other physical or mental condition that would impair your ability to properly use this tree stand.

NEVER use this tree stand on a tree that is dead, leaning, diseased, loose barked or on a utility pole as the tree may fall, break, or uproot and may result in serious injury or death.

NEVER rely on a branch for support.

NEVER jump or bounce on the tree stand's platform or ladder sections to seat it to the tree.

NEVER transport any of your equipment with yourself while ascending or descending the tree. You will need to have two hands free during ascending and descending for safety. Use a haul line to pull up your firearm (unloaded, chamber opened with safety lock engaged, barrel facing towards the ground), bows, arrows, knives or any other equipment to your tree stand once you have reached your desired hunting height. **ONLY** pull up hunting equipment after the tree stand has been secured to the tree and after you and your harness have been secured to the tree. Prior to descending, lower your equipment on the opposite side of the tree from which you are climbing. Make sure that the unloaded firearm's safety lock is engaged and the gun barrel is pointing towards the ground.

DO NOT carry the stand when ascending or descending the tree. Use a haul line to raise and lower your stand.

ALWAYS hunt with a plan and a buddy. Before you leave home, let others know your exact location, when you plan to return and who is with you.

ALWAYS carry emergency signal devices such as a cell phone, walkie-talkie, whistle, signal flare, PLD (personal location device) and flashlight with you at all times and within reach even while you are suspended in your harness. Watch for changing weather conditions. In the event of an accident, remain calm and seek help immediately.

ALWAYS inspect the tree stand and the Fall Arrest System (FAS) (Harness) for signs of wear or damage **BEFORE** each use. Also inspect to ensure that nuts and bolts are secure. Pay special attention to the harness and straps, guaranteeing that nothing has been frayed or severed. Destroy all products that cannot be repaired by the manufacturer. Contact a Customer Service Representative for replacement parts. The Fall Arrest System **MUST** be discarded and replaced after a fall has occurred.

NEVER modify your tree stand in any way by making repairs, replacing parts, or altering adding or attaching anything to it except if explicitly authorized in writing by the manufacturer. Improper installation or adjustment may cause serious injury or death. Remove all contents from box. Inspect for any damaged or missing parts. If any parts are missing or damaged, you must only use certified replacement parts. Using any other replacement parts will void product warranty. **THERE ARE NO EXTRA PARTS.** All parts **MUST** be used to ensure the safety of you and your stand. If you think parts are missing or damaged, **STOP IMMEDIATELY** and contact our Customer Service Department. Using the tree stand with missing or damaged parts may result in serious injury or death. Contact a Customer Service Representative if you have any missing, damaged or extra parts.

PRACTICE installing, adjusting and using hang-on tree stands at ground level prior to using it at an elevated position.

ALWAYS keep instructions (written and video) in a safe place and review before each use. It is the responsibility of the tree stand owner to furnish the complete instructions to anyone who borrows or purchases the tree stand from you.

NEVER use this tree stand for any use other than hunting. Our tree stands are designed for hunter's to wear a Full Body Harness. If you are not completely comfortable and confident with your ability to safely install, ascend, hunt and descend using a Full Body Safety Harness and this tree stand, **DO NOT PROCEED.**

NEVER use this tree stand for trimming trees.

NEVER fall asleep in your stand as you may fall out resulting in serious injury or death.

ALWAYS be sure to retighten all bolts **BEFORE** each new use of tree stand

ALWAYS have a minimum of three people present when installing or removing this tree stand

2013
©2013 (rev. 06/12)

TREESTAND SAFETY WARNINGS

Correct tightening and adjustments of chains, cables, straps, etc. are critical to stable hang-on installation. All tree stand contact points **MUST** be in contact with the tree before you step down on your tree stand.

NEVER adjust your stand while in use. Practice the attachment of this treestand at ground level before using in a hunting environment. **ALWAYS** ensure that you and your treestand are safely secured to a healthy tree. Your tree stand **MUST** be attached tightly to the tree and secured in place. If the stand is not secure, it may shift while in use, resulting in serious injury or death.

DO NOT leave your treestand outside since weather or animals may cause damage. Tree growth can also cause stress and damage straps and buckles. It must be stored inside when not in use.

Climbing aids such as stick ladders, sectional ladders, steps or such **MUST** extend above the platform of the hang-on to allow the user to step down on the platform. **NEVER** step up to the platform. When using a climbing belt to ascend the tree, the Full Body Harness should be attached to the tree before stepping down into the treestand.

NEVER wear jewelry or loose fitting clothing, which can cause hazardous conditions. Clothing may be caught in your equipment and cause you to fall. You must always wear non-slip or rubber boots. Shoelaces must be tucked into your boots. Rings and necklaces **MUST NOT** be worn.

NEVER use this treestand with a second person. The treestand is designed for use by **ONE** person.

NEVER let children use this treestand without adult supervision. This treestand is not a toy. No one under the age of 18 should attempt to use this product without direct adult supervision.

DO NOT use tree stand if any nuts or bolts or parts are loose, bent, or crooked.

ALWAYS know your physical limitations. Don't take chances. If you start thinking about how high you are, don't go any higher. Instead, choose a minimum height that will allow for safe, effective and comfortable hunting.

ALWAYS lean **forward towards the tree** as you climb. **NEVER** lean out from the treestand for any reason.

NEVER step up from a climbing device to get into your stand. Hang-on climbing aids **MUST** be placed on the tree at a height above the platform where you can maintain a handhold on the unit and step downwards onto the treestand.

ALWAYS inspect every stick ladder connection every time you use the stick ladder **BEFORE** you leave the ground. If stick ladder sections are separating, **DO NOT** use the stick ladder. Sectional ladders and steps should be spaced on the tree to ensure each step is no more than 18 inches apart.

ALWAYS wear a Fall Arrest System (FAS) (Harness) consisting of a full body safety harness with lineman's belt after leaving the ground. A TMA Certified Full Body Harness with lineman's belt must always be connected to yourself and the tree during ascending, hunting and descending. The use of a lineman's belt is **REQUIRED AT ALL TIMES** during ascending, hunting and descending the tree stand. When using a lineman's belt to ascend the tree, the full body harness **MUST** be attached to the tree before stepping onto the tree stand. The length of the harness tether strap must be minimized at all times. It should be adjusted so that it is above the head with no slack in the sitting position and you should have the minimum amount of slack possible when climbing.

You **MUST** stay connected at all times after leaving the ground while using climbing aids, hang-ons and climbing tree stands. Single safety belts and chest harnesses are no longer allowed and should **NEVER** be used. If you are not wearing a Full Body Harness properly attached to the tree, that is protecting you from a fall, **DO NOT leave the ground**. Failure to wear your Full Body Harness may result in serious injury or death.

Be aware that falls can occur at anytime after leaving the ground.

ALWAYS read and understand the manufacturer's Warnings, expiration date (if applicable) and instructions on how to use and how to properly adjust the harness. Practice the use of a full body safety harness at ground level in the presence of a responsible adult to experience the feeling of hanging suspended before using in a hunting environment. Failure to follow harness instructions may result in not being able to return to the stand and being suspended in a harness after a fall, or serious injury or possibly death. If the hunting location is unknown by anyone and communication efforts are unsuccessful, you **MUST** have a personal plan for rescue/escape because prolonged suspension in a harness may be fatal. It is important to exercise the legs by pushing against the tree or doing other forms of continuous leg exercises to avoid blood pooling while being suspended. Hunters with varying degrees of physical fitness may require different plans to recover/escape the effects of prolonged suspension. Have a personal plan and practice it in the presence of a responsible adult before leaving the ground. No one escape/rescue plan will work for every hunter on every tree in every circumstance. Only you can determine the best recovery/escape plan for your situation before leaving the ground.

ALWAYS have a suspension relief device on your person and readily accessible while using a harness. These devices allow the user to relieve the load on the lower extremities if suspended in a harness and help maintain circulation in the legs, mitigate suspension trauma (blood pooling) or allow descent to the ground. Several optional products/systems are available that offer self-recovery or self-extraction from a fall when suspended in a harness. Some systems automatically descend the user while others allow user control. One of these products/systems can be considered for use as an additional safety precaution against prolonged suspension and suspension trauma. Be sure to follow the manufacturers' instructions on the safe use of these products/systems.

Hunt from the ground when self-recovery escape is absent. There is time to make a correct decision on what action to take if a fall occurs while wearing a full body harness. It is important to remember "**DO NOT PANIC.**" Remain calm and implement your practiced rescue, relief and recovery plan.

NEVER allow the tether strap to get under your chin or around our neck. The length of the harness tether **MUST** be minimized at all times. It should be adjusted so that it is above the head with no slack (snug) in the sitting position and you should have the minimum amount of slack possible when climbing.

WARNING

DO NOT use this tree stand without reading and following all warnings and instructions before each use. Failure to do so may result in serious injury or death.

ALWAYS inspect your tree stand before each use and **DO NOT** use if parts are missing, worn, or damaged.

ALWAYS wear a Full Body Harness while using this stand. Failure to wear a full body harness while using this tree stand may result in serious injury or death.

DO NOT exceed the tree stand's weight limit (100 lbs. weight limit which includes your body weight, the weight of your clothes and gear. Exceeding the weight limit may cause the tree stand to become unstable, resulting in serious injury or death.

NEVER stand on tree stand seat, footrest, armrest, or step. Standing on any of these parts may result in break or fall resulting in serious injury or death.

NEVER make alterations, modifications, or repairs to the tree stand. Alterations, modifications, or repairs may void all warranties.

NEVER use the tree stand if it is damaged, leaning, wet or slippery. A slippery tree may fall, break, or cause serious injury or death.

NEVER use the tree stand during inclement weather. **DO NOT** use the tree stand during thunderstorms or any other weather condition including (but not limited to) lightning, freezing rain, high wind that could create a slippery or dangerous condition.

DO NOT use the tree stand under the influence of alcohol, drugs, or medication. Using tree stand under the influence of alcohol, drugs, or medication may result in serious injury or death.

DO NOT use tree stand if you have dizzy spells, a heart problem, are afraid of heights, have been advised by a doctor or other health care provider not to climb, or have any condition that would impair your ability to climb up or down or use tree stand as it could result in serious injury or death.

NEVER remove or deface tree stand warning labels. Replacement labels can be obtained from the address below.

NEVER remove any safety warning stickers from this product.

Safety must be your first priority during the use of this product.

©2013 (rev. 06/12)

CHOOSING A SAFE TREE

- **ALWAYS** thoroughly inspect the tree before installing your product. **DO NOT** install your **TREE/LADDER STAND** onto any dead or unsafe tree, telephone or utility pole, structural column, or man-made structure. Doing so may result in serious injury or death.
- **ALWAYS** select the proper tree for use with your **TREE/LADDER STAND**. Select a live straight tree that fits within size limits recommended (minimum tree diameter must be no less than 9 inches and maximum of 18 inches.). **DO NOT** rely on a branch for support.
- **DO NOT** select a tree in the dark or choose a tree in close proximity to a fence. You must not have any stumps or rocks beneath your tree.
- **NEVER** use **TREE/LADDER STAND** on a tree that is dead, diseased, leaning or on wet and uneven ground as the tree may fall, break or uproot.
- Your tree must not be wet, icy or slippery or on wet, swampy, or loose ground that allows the tree to be unstable. Check the ground under **TREE/LADDER STAND** to ensure it is firm and level.
- Be sure you have a level stand platform. Your tree must not lean or have any irregular shape.
- Tree must not have any loose or scaly bark or excessive vines, nails, screws, or any other sharp objects protruding that may sever webbing on product. Any surrounding trees must not lean or have dead limbs that may fall onto you or your product.
- **NEVER HURRY!! HURRYING CAUSES ACCIDENTS!!** While climbing a **TREE/LADDER STAND**, make slow, even movements no more than ten to twelve inches at a time. Make sure you have proper contact with tree and/or **TREE/LADDER STAND** every time you move. On ladder tree stand, **ALWAYS** maintain three points of contact with each step and **ALWAYS** lean forward as you climb.

Several treestands are equipped with a footrest, armrests and/or shooting rail. Neither the footrest, armrests nor the shooting rail have been designed to support a user's weight. Under **NO** circumstances should you place more than fifteen (15) pounds of weight on these structures. Doing so will put the user in serious risk of injury or death.

PROPER CARE AND MAINTENANCE:

- Inspect for defects (damage, rot, corrosion, cracks, freezing, excessive heat, etc.) before every use is required. Do not use if damage is detected or suspected.
- We recommend replacing all hardware/cables/nuts/bolts/clips on your tree stand every two (2) years or sooner if inspection finds it necessary. Use only Primal Vantage approved replacement straps and parts. Use of any other straps or parts, will be viewed as a modification to the product. Any modification will void the warranties and relieve Primal Vantage from all liabilities. Failure to follow these instructions may result in serious injury or death.
- **DO NOT** overtighten the hardware. **DO NOT** use a socket wrench. This can lead to structural damage and may negatively affect the performance of your stand. Failure to follow these instructions may result in serious injury or death.
- All photos are taken from the front view unless otherwise noted.
- By registering your product, you may be enrolled in our discount program.
You may receive a 20% off coupon for our website store, www.primal-store.com to purchase replacement parts in the future.
- In most cases, bolts come with two nylon washers. One washer will be placed against the bolt head the other washer will be placed against the nut.

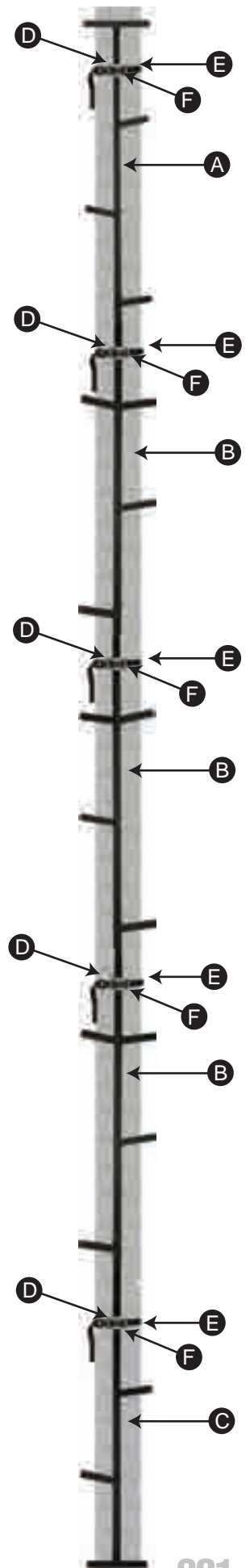
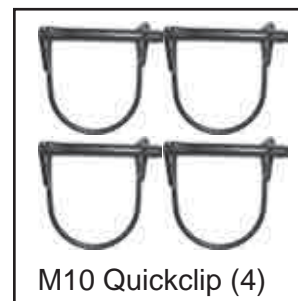
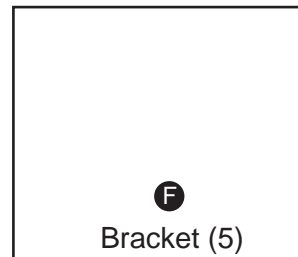
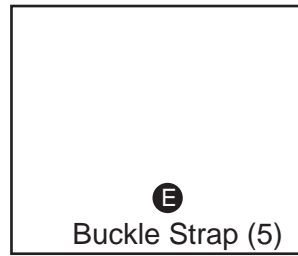
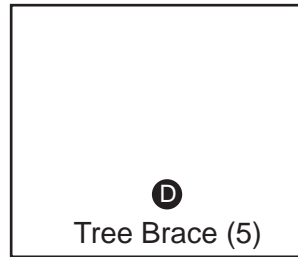
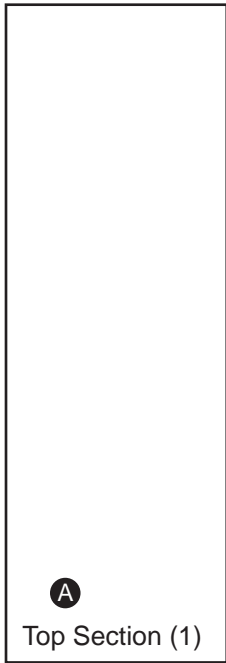

PARTS LIST

- A** 1 Top Section.....Part # WL-1000
- B** 3 Middle Section.....Part # WL-1250
- C** 1 Bottom Section.....Part # WL-1500
- D** 5 Tree Brace.....Part # WTB-100
- E** 5 Buckle Strap.....Part # CB-100
- F** 5 Bracket.....Part # WB-100
- 65** 5 M12x65mm Bolt.....Part # 1265W w/wingnut
- 4 M10 Quickclip.....Part # 1615

Tools Required

Adjustable Wrench



ASSEMBLY INSTRUCTIONS

MODEL: WMSL-125
20FT. STICK LADDER

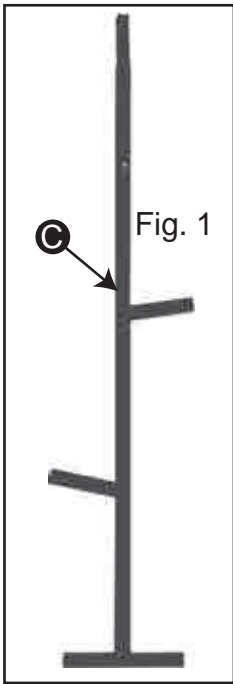

1. Lay Bottom Section **C** on the ground with the first step on the left hand side. (Fig. 1).

2. The first step of Middle Section **B** should be facing the left hand side. Insert the male end of Bottom Section **C** into the female end of Middle Section **B**. (Fig. 2) Insert one quickclip through each section at the insertion point. (Fig. 3)

The steps will need to be in an alternating left, right, left, right pattern. Make sure that the **Bottom, Lower Middle, and the Upper Middle Sections** have the first step on the **LEFT** hand side.

The **Second Middle Section and the Top Ladder Section** will have the first step on the **RIGHT** hand side.

3. Insert the rest of the sections together by following the above steps. Make sure all connections are tightened securely. Insert one quickclip into each section at each insertion point. (Fig.3)

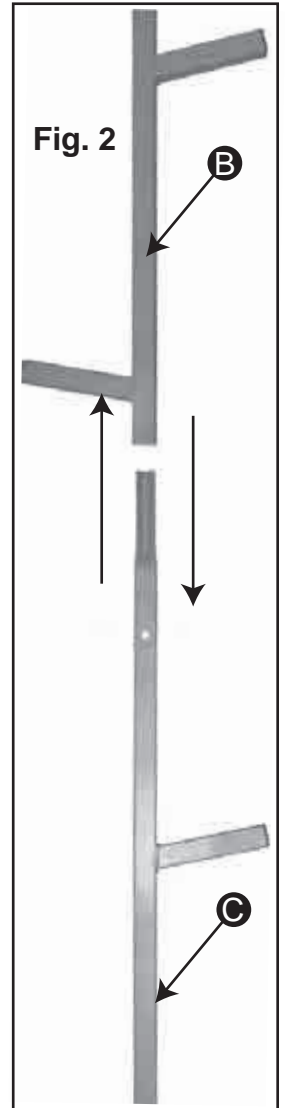
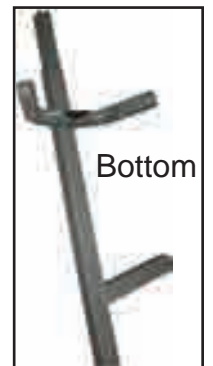
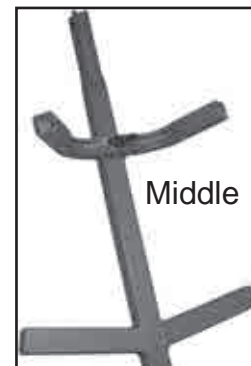
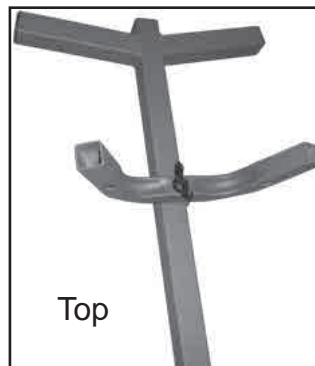
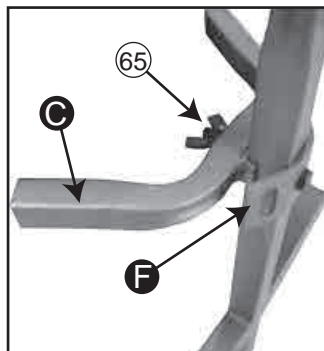
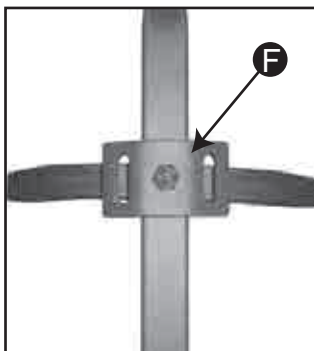
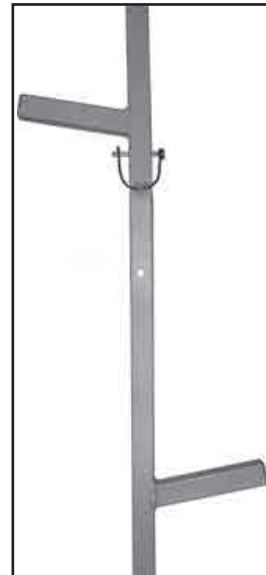

Fig. 3



4. Attach Bracket **F** to the front of each stick ladder section and Tree Brace **D** to the back of each stick ladder section using **1 - M12x65mm Bolt** for each section. Wingnut must be installed between the tree brace and the tree. Tighten securely.

INSTALLATION INSTRUCTIONS

MODEL: WMSL-125
20FT. STICK LADDER



1. Thread the buckle strap through one end of the bracket, over the top of the bracket, then through the other side of the bracket. Pull the strap all the way through so the buckle end is against the bracket. The straps will be attached to the bracket and hang freely until the Stick Ladder is ready to be secured to the tree.

2. Make sure that the steps of the stick ladder all angle upward. With the help of at least two other people, walk the assembled stick ladder up to the desired tree so that all of the tree braces are firmly against the tree. The stick ladder **MUST** be straight and vertical. **DO NOT** use on a leaning or dead tree. The tree should also have a diameter between 9 and 18 inches.

3. While holding the stick ladder against the tree, press your weight on the first step so that the base of the bottom section settles firmly and completely into the ground.

4. Wrap the Buckle Strap from the bottom section around the back of the tree and insert the strap through the buckle. (See Fig. 6) Make sure that the strap is flat against tree with no slack. Secure section to the tree before climbing.

5. Attach Full Body Safety Harness with Climbing Belt to yourself and the tree according to the manufacturer's instructions.

6. Climb the bottom section of the stick ladder to reach the Second Section. Stand on the Bottom Section to secure the second strap to the Middle Section. Make sure section is secure before climbing any further.

7. Continue with steps 4 through 6 for the remaining sections.

8. When installing and removing stick ladder sections do not undo any strap until you are standing securely on the section below.

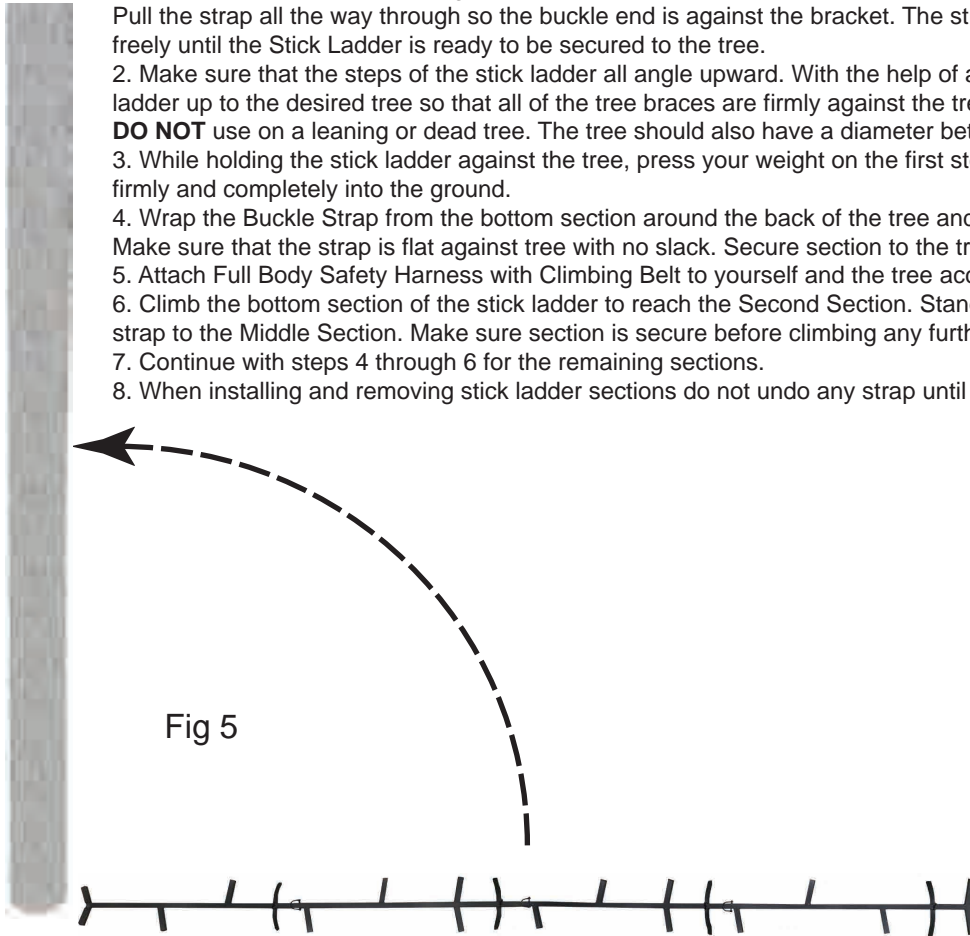

Fig 5

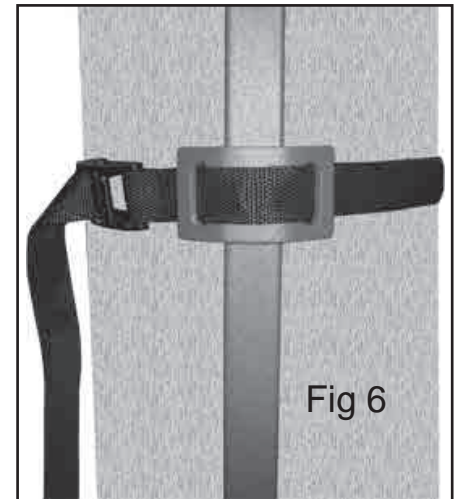
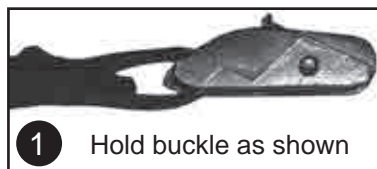
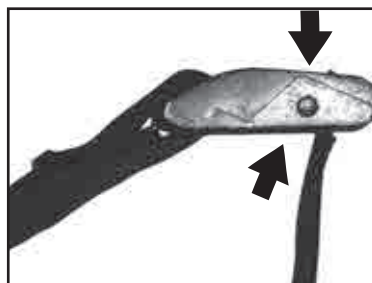

Fig 6

DETAILED BUCKLE AND STRAP INSTRUCTIONS



1 Hold buckle as shown



2 Press down on latch and insert strap underneath teeth as shown.

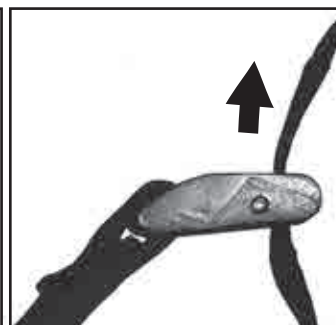

3 Pull strap to desired length.

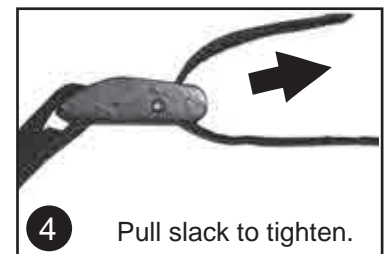

4 Pull slack to tighten.

Hunting For Low Prices?

These Items
Now Available at
Walmart and Walmart.com



20' STICK LADDER



HANG-ON TREESTAND



BONE COLLECTOR HANG-ON TREESTAND



CLIMBER

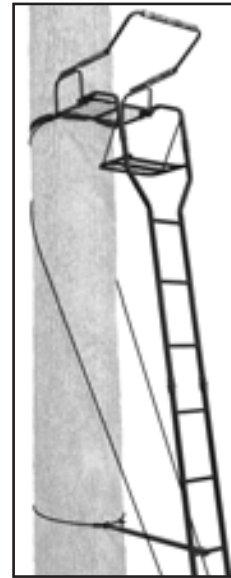

16' RECON LADDERSTAND



15' TWO-MAN LADDERSTAND

Check Out Walmart.com For Even More Tree Stands and Accessories



STEEL RAPID RAILS



BONE COLLECTOR AVENGER ALUMINUM HANG-ON TREESTAND



15' TRIPOD



TRIPOD ROOF KIT