

HANG-ON TREE STAND

MODEL: WMHO-200

- Always Wear a Safety Harness with this Product
- Practice Using at Ground Level
- Weight Limit: 300 lbs.
- Tree Size: 9"-18" diameter

Instruction and Safety Manual



Warning

Every year serious injury and even death occurs from hunting related falls. To ensure your safety, please **COMPLETELY** read and follow this safety manual and **ALL** warning labels **BEFORE** assembling, installing or utilizing this product.

DO NOT USE THIS PRODUCT BEFORE FULLY UNDERSTANDING ALL SAFETY WARNINGS AND INSTRUCTIONS. IF YOU HAVE QUESTIONS, ARE UNSURE ABOUT ANY INFORMATION OR NEED ADDITIONAL INFORMATION CONCERNING YOUR PRODUCT, CONTACT OUR CUSTOMER SERVICE DEPARTMENT AT 1-866-972-6168 OR VISIT WWW.TREESTANDCUSTOMERSERVICE.COM. KEEP AND MAINTAIN THIS SAFETY AND INSTRUCTION MANUAL IN A SAFE LOCATION FOR FUTURE REFERENCE.

Tools Required

Adjustable Wrench



TREESTAND SAFETY WARNINGS

Please read the following instruction manual and warnings labels completely before utilizing this product. Failure to understand and execute the instructions and warnings may result in serious injury or death. In the event of an accident, have a plan for rescue, including the use of devices that may be easily reached while suspended.

ALWAYS read and understand all warnings and instructions and use all safety products provided before each use of this product. Failure to read and understand all warnings and instructions may result in serious injury or death. Contact a Customer Service Representative with any questions you may have.

NEVER exceed total weight limit of **300 lbs.** **DO NOT** use if your combined weight with all of your hunting gear and any accessories exceeds **300 lbs.** Use of tree stand over the weight limit may result in serious injury or death.

DO NOT use this tree stand while under the influence of alcohol, medication or any illegal substances. Use of tree stand while under the influence of any of these substances may result in serious injury or death.

NEVER use this treestand during inclement weather. **DO NOT** use tree stand during thunderstorms, snowstorms, hurricanes, tornadoes or any other weather conditions that include (but not limited to) lightning, icy conditions, or high winds that could create slippery or dangerous situations. End your hunt and return to the ground if inclement weather conditions arise.

NEVER use treestand if you are feeling ill, nauseous, dizzy or if you have a prior condition that could cause a problem. i.e., heart condition, joints that lock-up spinal fusions, etc., or if you are not well rested and alert. Physical ailments can reduce your ability to safely install, utilize, and remove your treestand. Please consult a physician prior to use.

NEVER use this tree stand if you have a history of health problems such as (but not limited to) heart problems, back problems, high blood pressure, impaired vision, equilibrium impairments, are afraid of heights, have been advised by a doctor or physician not to climb. If you are not physically fit, well rested, and alert, or if you have any other physical or mental condition that would impair your ability to properly use this treestand.

NEVER use this tree stand on a tree that is dead, leaning, diseased, loose barked or on a utility pole as the tree may fall, break, or uproot and may result in serious injury or death.

NEVER rely on a branch for support.

NEVER jump or bounce on the treestand's platform or ladder sections to seat it to the tree.

NEVER transport any of your equipment with yourself while ascending or descending the tree. You will need to have two hands free during ascending and descending for safety. Use a haul line to pull up your firearm (unloaded, chamber opened with safety lock engaged, barrel facing towards the ground), bows, arrows, knives or any other equipment to your tree stand once you have reached your desired hunting height. **ONLY** pull up hunting equipment after the tree stand has been secured to the tree and after you and your harness have been secured to the tree. Prior to descending, lower your equipment on the opposite side of the tree from which you are climbing. Make sure that the unloaded firearm's safety lock is engaged and the gun barrel is pointing towards the ground.

DO NOT carry the stand when ascending or descending the tree. Use a haul line to raise and lower your stand.

ALWAYS hunt with a plan and a buddy. Before you leave home, let others know your exact location, when you plan to return and who is with you.

ALWAYS carry emergency signal devices such as a cell phone, walkie-talkie, whistle, signal flare, PLD (personal location device) and flashlight with you at all times and within reach even while you are suspended in your harness. Watch for changing weather conditions. In the event of an accident, remain calm and seek help immediately.

ALWAYS inspect the tree stand and the **Fall Arrest System (FAS)** (Harness) for signs of wear or damage **BEFORE** each use. Also inspect to ensure that nuts and bolts are secure. Pay special attention to the harness and straps, guaranteeing that nothing has been frayed or severed. Destroy all products that cannot be repaired by the manufacturer. Contact a Customer Service Representative for replacement parts. The Fall Arrest System **MUST** be discarded and replaced after a fall has occurred.

NEVER modify your treestand in any way by making repairs, replacing parts, or altering adding or attaching anything to it except if explicitly authorized in writing by the manufacturer. Improper installation or adjustment may cause serious injury or death. Remove all contents from box. Inspect for any damaged or missing parts. If any parts are missing or damaged, you must only use certified replacement parts. Using any other replacement parts will void product warranty. **THERE ARE NO EXTRA PARTS.** All parts **MUST** be used to ensure the safety of you and your stand. If you think parts are missing or damaged, **STOP IMMEDIATELY** and contact our Customer Service Department. Using the tree stand with missing or damaged parts may result in serious injury or death. Contact a Customer Service Representative if you have any missing, damaged or extra parts.

PRACTICE installing, adjusting and using hang-on treestands at ground level prior to using it at an elevated position.

ALWAYS keep instructions (written and video) in a safe place and review before each use. It is the responsibility of the treestand owner to furnish the complete instructions to anyone who borrows or purchases the treestand from you.

NEVER use this treestand for any use other than hunting. Our treestands are designed for hunter's to wear a Full Body Harness. If you are not completely comfortable and confident with your ability to safely install, ascend, hunt and descend using a Full Body Safety Harness and this treestand, **DO NOT PROCEED.**

NEVER use this treestand for trimming trees.

NEVER fall asleep in your stand as you may fall out resulting in serious injury or death.

ALWAYS be sure to retighten all bolts **BEFORE** each new use of treestand.

ALWAYS have a minimum of three people present when installing or removing this treestand.

TREESTAND SAFETY WARNINGS

Correct tightening and adjustments of chains, cables, straps, etc. are critical to stable hang-on installation. All tree stand contact points **MUST** be in contact with the tree before you step down on your tree stand.

NEVER adjust your stand while in use. Practice the attachment of this treestand at ground level before using in a hunting environment. **ALWAYS** ensure that you and your treestand are safely secured to a healthy tree. Your tree stand **MUST** be attached tightly to the tree and secured in place. If the stand is not secure, it may shift while in use, resulting in serious injury or death.

DO NOT leave your treestand outside since weather or animals may cause damage. Tree growth can also cause stress and damage straps and buckles. It must be stored inside when not in use.

Climbing aids such as stick ladders, sectional ladders, steps or such **MUST** extend above the platform of the hang-on to allow the user to step down on the platform. **NEVER** step up to the platform. When using a climbing belt to ascend the tree, the Full Body Harness should be attached to the tree before stepping down into the treestand.

NEVER wear jewelry or loose fitting clothing, which can cause hazardous conditions. Clothing may be caught in your equipment and cause you to fall. You must always wear non-slip or rubber boots. Shoelaces must be tucked into your boots. Rings and necklaces **MUST NOT** be worn.

NEVER use this treestand with a second person. The treestand is designed for use by **ONE** person.

NEVER let children play with or use this treestand without adult supervision. This treestand is not a toy. No one under the age of 18 should attempt to use this product without direct adult supervision.

DO NOT use tree stand if any nuts or bolts or parts are loose, bent, or crooked.

ALWAYS know your physical limitations. Don't take chances. If you start thinking about how high you are, don't go any higher. Instead, choose a minimum height that will allow for safe, effective and comfortable hunting.

ALWAYS lean **forward towards the tree** as you climb. **NEVER** lean out from the treestand for any reason.

NEVER step up from a climbing device to get into your stand. Hang-on climbing aids **MUST** be placed on the tree at a height above the platform where you can maintain a handhold on the unit and step downwards onto the treestand.

ALWAYS inspect every stick ladder connection every time you use the stick ladder **BEFORE** you leave the ground. If stick ladder sections are separating, **DO NOT** use the stick ladder. Sectional ladders and steps should be spaced on the tree to ensure each step is no more than 18 inches apart.

ALWAYS wear a Fall Arrest System (FAS) (Harness) consisting of a full body safety harness with lineman's belt after leaving the ground. A TMA Certified Full Body Harness with lineman's belt must always be connected to yourself and the tree during ascending, hunting and descending. The use of a lineman's belt is **REQUIRED AT ALL TIMES** during ascending, hunting and descending the tree stand. When using a lineman's belt to ascend the tree, the full body harness **MUST** be attached to the tree before stepping onto the tree stand. The length of the harness tether strap must be minimized at all times. It should be adjusted so that it is above the head with no slack in the sitting position and you should have the minimum amount of slack possible when climbing.

You **MUST** stay connected at all times after leaving the ground while using climbing aids, hang-ons and climbing tree stands. Single safety belts and chest harnesses are no longer allowed and should **NEVER** be used. If you are not wearing a Full Body Harness properly attached to the tree, that is protecting you from a fall, **DO NOT leave the ground**. Failure to wear your Full Body Harness may result in serious injury or death. Be aware that falls can occur at anytime after leaving the ground.

ALWAYS read and understand the manufacturer's Warnings, expiration date (if applicable) and instructions on how to use and how to properly adjust the harness. Practice the use of a full body safety harness at ground level in the presence of a responsible adult to experience the feeling of hanging suspended before using in a hunting environment. Failure to follow harness instructions may result in not being able to return to the stand and being suspended in a harness after a fall, or serious injury or possibly death. If the hunting location is unknown by anyone and communication efforts are unsuccessful, you **MUST** have a personal plan for rescue/escape because prolonged suspension in a harness may be fatal. It is important to exercise the legs by pushing against the tree or doing other forms of continuous leg exercises to avoid blood pooling while being suspended. Hunters with varying degrees of physical fitness may require different plans to recover/escape the effects of prolonged suspension. Have a personal plan and practice it in the presence of a responsible adult before leaving the ground. No one escape/rescue plan will work for every hunter on every tree in every circumstance. Only you can determine the best recovery/escape plan for your situation before leaving the ground.

ALWAYS have a suspension relief device on your person and readily accessible while using a harness. These devices allow the user to relieve the load on the lower extremities if suspended in a harness and help maintain circulation in the legs, mitigate suspension trauma (blood pooling) or allow descent to the ground. Several optional products/systems are available that offer self-recovery or self-extraction from a fall when suspended in a harness. Some systems automatically descend the user while others allow user control. One of these products/systems can be considered for use as an additional safety precaution against prolonged suspension and suspension trauma. Be sure to follow the manufacturers' instructions on the safe use of these products/systems.

Hunt from the ground when self-recovery escape is absent. There is time to make a correct decision on what action to take if a fall occurs while wearing a full body harness. It is important to remember **"DO NOT PANIC."** Remain calm and implement your practiced rescue, relief and recovery plan.

NEVER allow the tether strap to get under your chin or around our neck. The length of the harness tether **MUST** be minimized at all times. It should be adjusted so that it is above the head with no slack (snug) in the sitting position and you should have the minimum amount of slack possible when climbing.



NEVER remove any safety warning stickers from this product.

Safety must be your first priority during the use of this product.

©2012 (rev. 12/11)

CHOOSING A SAFE TREE

- **ALWAYS** thoroughly inspect the tree before installing your product. **DO NOT** install your **TREE/LADDER STAND** onto any dead or unsafe tree, telephone or utility pole, structural column, or man-made structure. Doing so may result in serious injury or death.
- **ALWAYS** select the proper tree for use with your **TREE/LADDER STAND**. Select a live straight tree that fits within size limits recommended (minimum tree diameter must be no less than 9 inches and maximum of 18 inches.). **DO NOT** rely on a branch for support.
- **DO NOT** select a tree in the dark or choose a tree in close proximity to a fence. You must not have any stumps or rocks beneath your tree.
- **NEVER** use **TREE/LADDER STAND** on a tree that is dead, diseased, leaning or on wet and uneven ground as the tree may fall, break or uproot.
- Your tree must not be wet, icy or slippery or on wet, swampy, or loose ground that allows the tree to be unstable. Check the ground under **TREE/LADDER STAND** to ensure it is firm and level.
- Be sure you have a level stand platform. Your tree must not lean or have any irregular shape.
- Tree must not have any loose or scaly bark or excessive vines, nails, screws, or any other sharp objects protruding that may sever webbing on product. Any surrounding trees must not lean or have dead limbs that may fall onto you or your product.
- **NEVER HURRY!! HURRYING CAUSES ACCIDENTS!!** While climbing a **TREE/LADDER STAND**, make slow, even movements no more than ten to twelve inches at a time. Make sure you have proper contact with tree and/or **TREE/LADDER STAND** every time you move. On ladder tree stand, **ALWAYS** maintain three points of contact with each step and **ALWAYS** lean forward as you climb.

Several treestands are equipped with a footrest, armrests and/or shooting rail. Neither the footrest, armrests nor the shooting rail have been designed to support a user's weight. Under **NO** circumstances should you place more than fifteen (15) pounds of weight on these structures. Doing so will put the user in serious risk of injury or death.

PROPER CARE AND MAINTENANCE:

- Inspect for defects (damage, rot, corrosion, cracks, freezing, excessive heat, etc.) before every use is required. Do not use if damage is detected or suspected.
- We recommend replacing all hardware/cables/nuts/bolts/clips on your tree stand every two (2) years or sooner if inspection finds it necessary. Use only Primal Vantage approved replacement straps and parts. Use of any other straps or parts, will be viewed as a modification to the product. Any modification will void the warranties and relieve Primal Vantage from all liabilities. Failure to follow these instructions may result in serious injury or death.
- By registering your product, you may be enrolled in our discount program. You may receive a 20% off coupon for our website store, www.primal-store.com to purchase replacement parts in the future.
- **DO NOT** overtighten the hardware. **DO NOT** use a socket wrench. This can lead to structural damage and may negatively affect the performance of your stand. Failure to follow these instructions may result in serious injury or death.

HANG-ON TREE STAND

MODEL: WMHO-200

- Always Wear a Safety Harness with this Product
- Practice Using at Ground Level
- Weight Limit: 300 lbs.
- Tree Size: 9"-18" diameter



A Foot Platform (1)

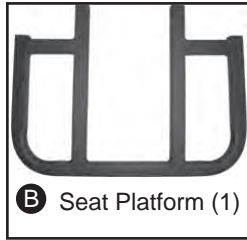

B Seat Platform (1)



C Vertical Support(1)

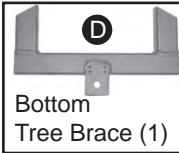

D Bottom Tree Brace (1)



E Top Tree Brace (1)

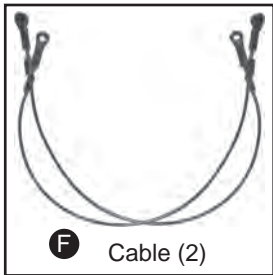

F Cable (2)

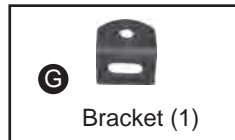

G Bracket (1)

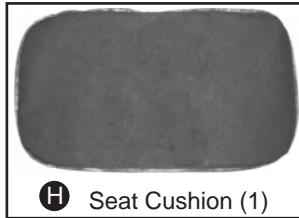

H Seat Cushion (1)



J Tree Strap (1)



K Buckle Strap (1)



L Backpack Strap (2)

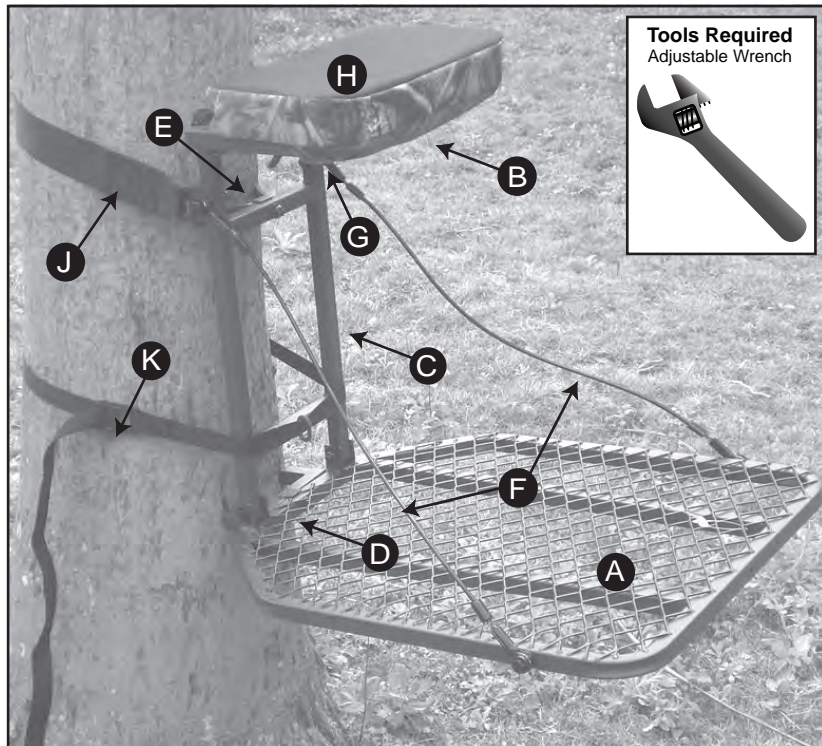

Tools Required
Adjustable Wrench



Parts List

A	1 Foot Platform	Part # WFP-538
B	1 Seat Platform	Part # WSP-200
C	1 Vertical Support	Part # WVP-530
D	1 Bottom Tree Brace	Part # WTB-530
E	1 Top Tree Brace	Part # WTB-531
F	2 Cable	Part # C-640
G	1 Bracket	Part # WB-200
H	1 Seat Cushion	Part # WSC-200
J	1 Tree Strap	Part # TS-530
K	1 Buckle Strap	Part # CB-100
L	2 Backpack Strap	Part # WBP-100
	1 Harness	Part # 2012-CW

Hardware

63	2 M12x60mm Bolt w/3 washers	Part # 1263
55	2 M12x55mm Bolt	Part # 1255
53	2 M12x50mm Bolt w/3 washers	Part # 1253
49	2 M12x45mm Bolt w/4 washers	Part # 1249
48	2 M12x45mm Bolt w/3 washers	Part # 1248
40	2 M12x40mm Bolt	Part # 1240

Hardware Blister Pack

63		M12x60mm w/ 3 washers
53		M12x50mm w/3 washers
55		M12x55mm
48		M12x45mm w/ 3 washers
49		M12x45mm w/ 4 washers
40		M12x40mm

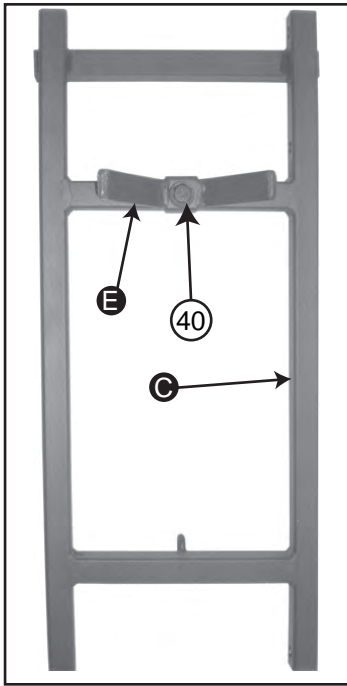

1. Attach Top Tree Brace **E** to Vertical Support **C** using **1-M12x40mm bolt**.

Attach to the opposite side from the ring on the lower part of the vertical support

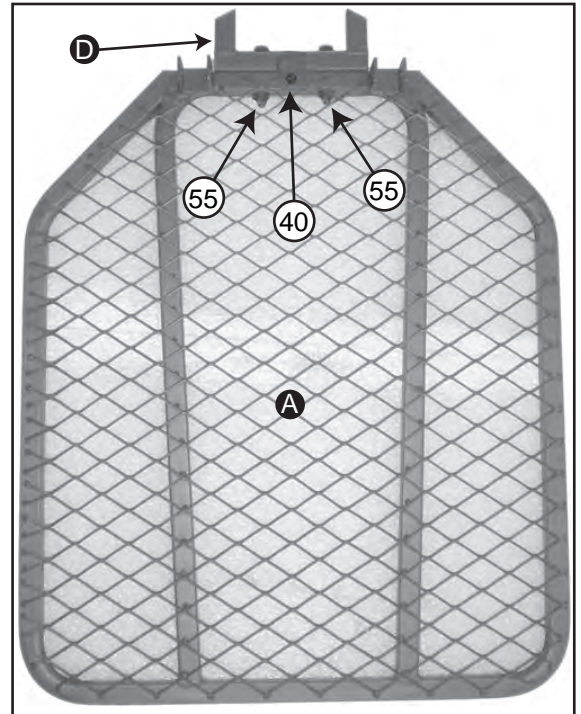

2. Attach Bottom Tree Brace **D** to the rear of Foot Platform **A** using **2-M12x55mm bolts** and **1-M12x40mm bolt**.

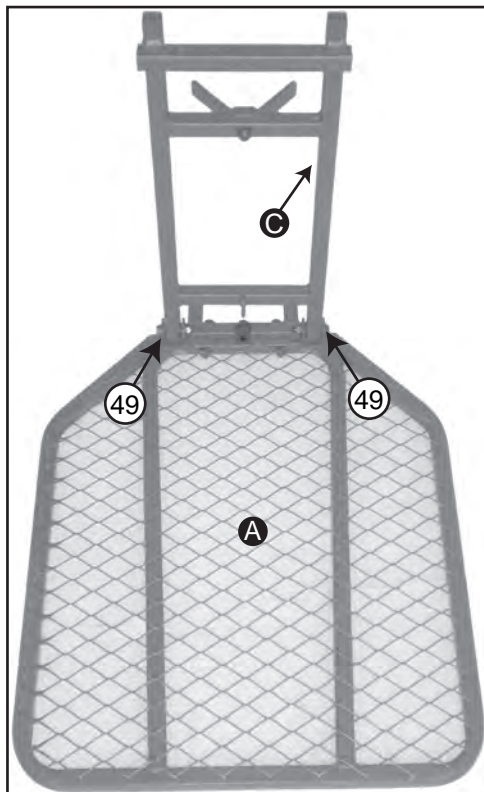

3. Attach Vertical Support **C** to Rear of Platform **A** using **1-M12x45mm bolt w/ 4 washers** on each side. **(See Closeup).**

Make sure that the braces are facing towards the tree and the ring is facing towards the platform.

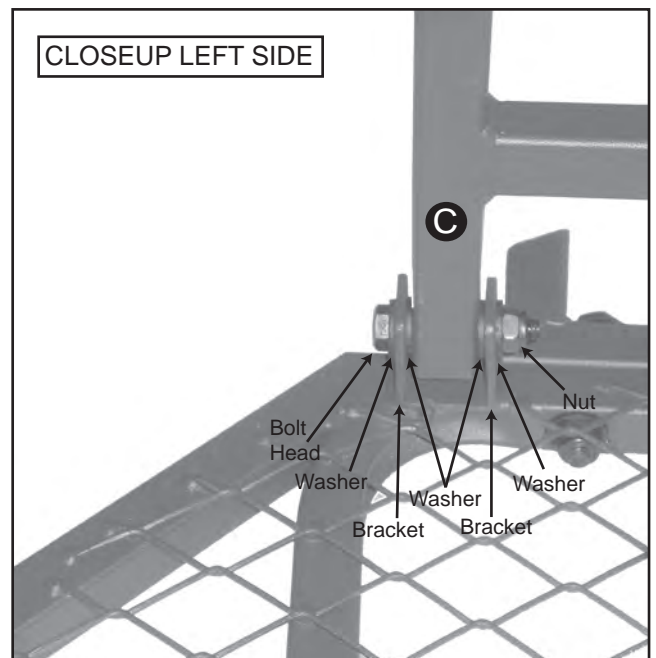

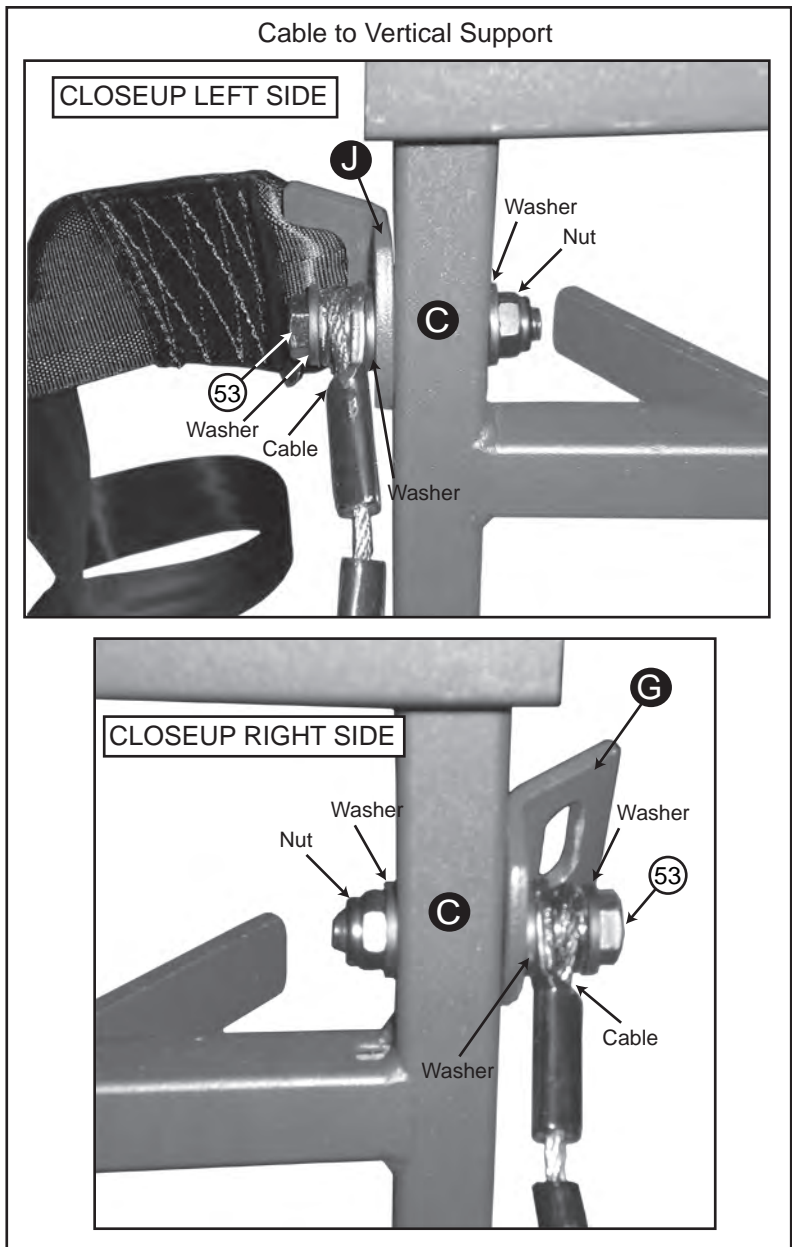
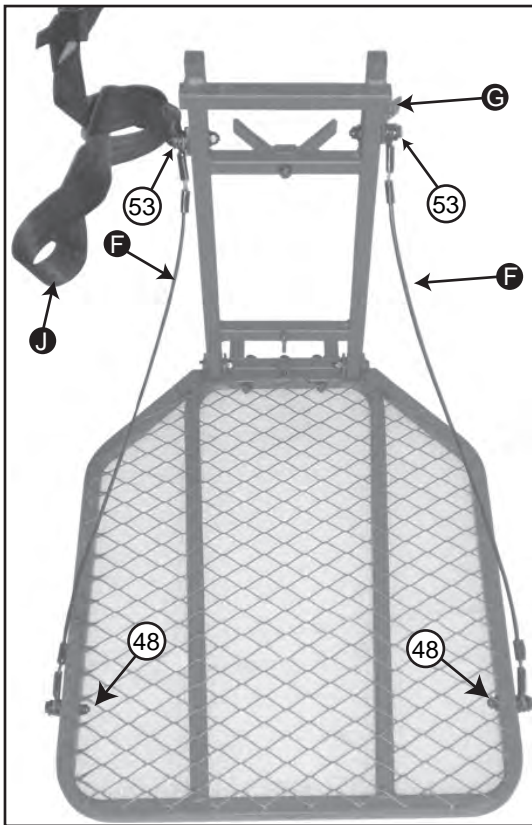

4. Attach one end of Cable **F** to the front of Foot Platform **A** using **1-M12x45mm bolt with 3 washers on both sides.** (See Cable to Platform Diagram Below)

On the Right Hand Side of the Vertical Support, attach the other end of Cable **F** through Bracket **G** to Vertical Support **C** using **1-M12x50mm bolt with 3 washers.**

On the Left Hand Side of the Vertical Support, attach the other end of the other Cable **F** through Treestrap **J** to the Vertical Support **C** using **1-M12x50mm bolt with 3 washers.**

(See Cable to Vertical Support Diagrams)

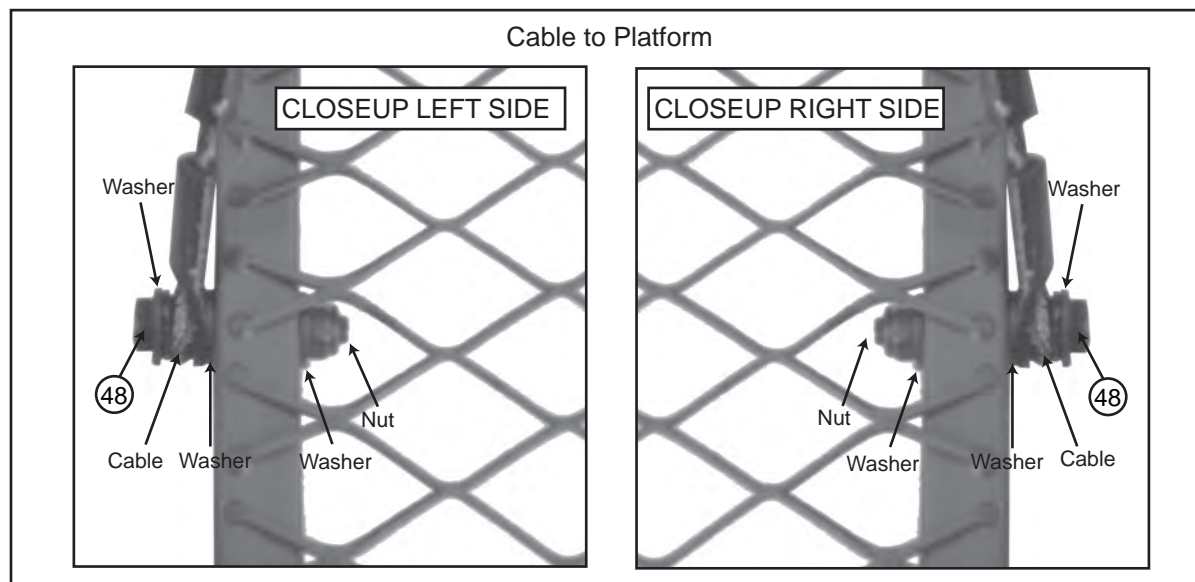

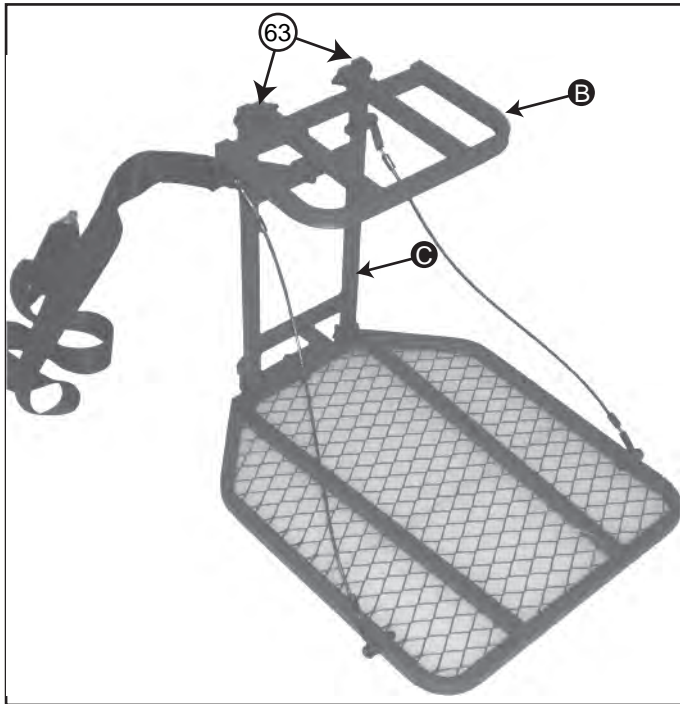

5. Attach Seat Platform **B** to the top of Vertical Support **C** using **1-M12x60mm bolt with 3 washers** on each side.

Insert a washer on the bolt, then insert the bolt through Vertical Support **C**, insert another washer on the bolt, then insert the bolt through Seat Platform **B**. Insert the last washer on the bolt and tighten the nut. (**See Closeup Photo Below**)

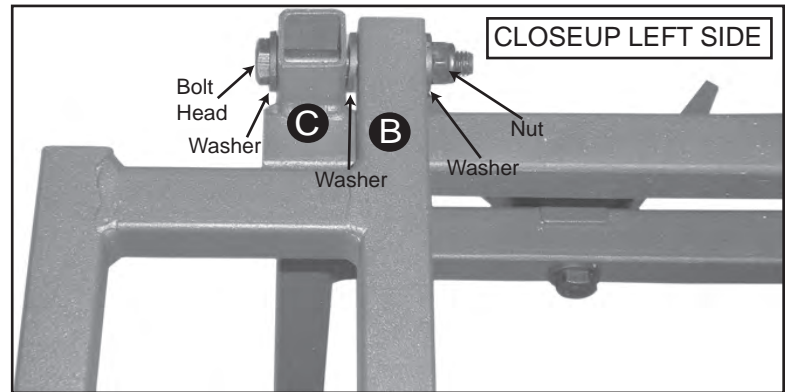

6. Attach Seat Cushion **H** to the top of Seat Platform **B**.

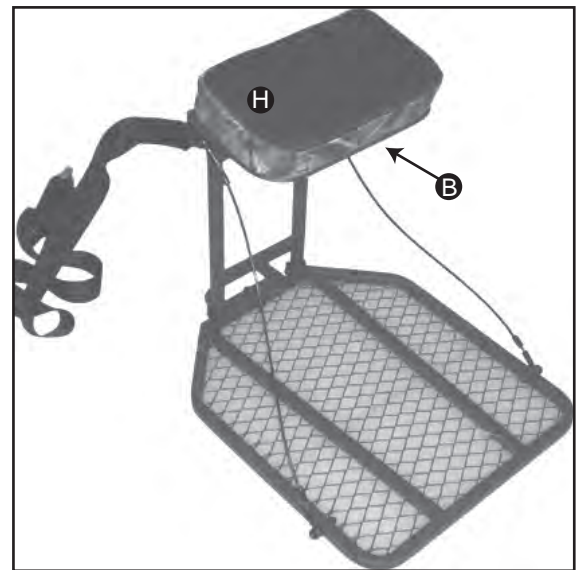

CHOOSING A SAFE TREE

ALWAYS thoroughly inspect the tree before installing your product. **DO NOT** install your Hang-on on to any dead or unsafe tree, telephone, or utility pole, structural column, or man-made structure. Doing so may result in serious injury or death.

ALWAYS select the proper tree for use. Select a live straight tree that fits within the size limits recommended (minimum diameter must be no less than 9" and maximum 18")

DO NOT select a tree in the dark or choose a tree in close proximity to a fence. You must not have any stumps or rocks beneath your tree.

NEVER use treestand on a tree that is dead, diseased leaning or on wet or uneven ground as the tree may fall, break, or uproot.

- Your tree must not be wet, icy, slippery or on wet, swampy, or loose ground that allows the tree to be unstable.
- You must have a level platform. Your tree must not lean or have an irregular shape.
- Your tree must not have loose or scaly bark or excessive vines. Any surrounding trees must not lean or have excessive dead limbs that may fall onto you or your product
- Your tree must not have any nails, screws, or any other sharp objects protruding that may sever the webbing on your product.

NEVER rely on a branch for support.

NEVER HURRY While climbing with a treestand, make slow, even movements no more than ten to twelve inches at a time. Make sure you have proper contact with the tree and/or treestand every time you move. Maintain three points of contact at all times.

ATTACHMENT INSTRUCTIONS

MODEL: WMHO-200
BASIC HANG-ON



FIGURE 1

STEP 1: While wearing your safety harness, connect your climbing belt to the tree following manufacturer's instructions. Climb to the desired height using your climbing aid. Once you have reached the desired height, hoist your treestand into position.

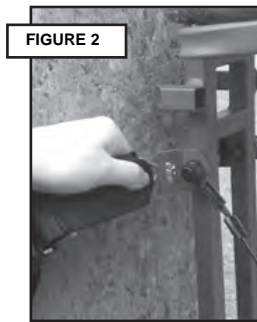

FIGURE 2

STEP 2: With the treestand in the folded position, wrap Tree Strap around the tree once and hook the other end into the tree strap bracket. (See Fig.1 and Fig. 2.) Ensure that the strap is not twisted and is laying flat against the tree.

This should be done beneath where your climbing belt is attached to the tree so that your climbing belt is above the treestand.

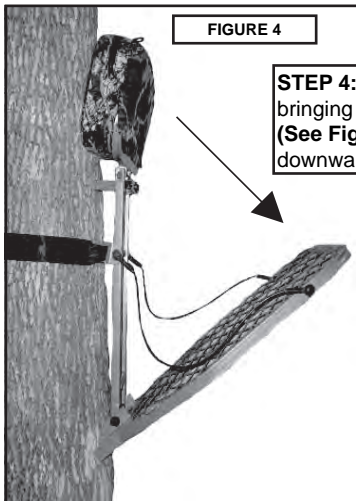

FIGURE 4

STEP 4: Unfold the stand by bringing the platform downward (See Fig.4) Pull seat platform downward and adjust seat.

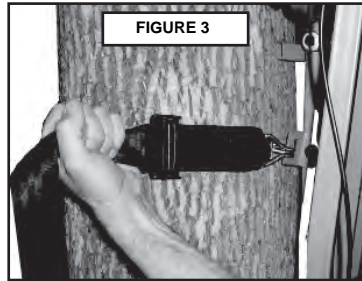

FIGURE 3

STEP 3: Pull the excess strap to secure the stand to the tree, as shown in Fig. 3. The stand should be tight to the tree as shown in Fig. 1.

STEP 5: Insert the Buckle Strap through the ring on the Vertical Support. Wrap the strap around the tree once and insert the strap through the buckle. Pull excess strap to tighten. (See Buckle Instructions Below)

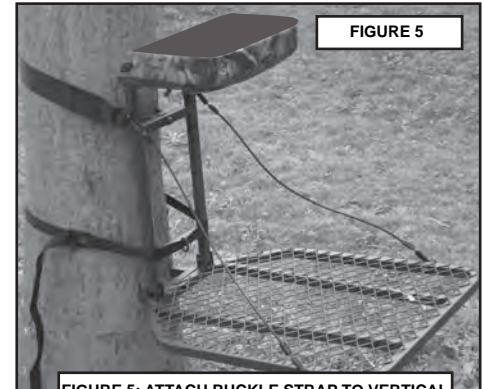

FIGURE 5

FIGURE 5: ATTACH BUCKLE STRAP TO VERTICAL SUPPORT TO SECURE STAND TO TREE



FIGURE 6

STEP 6: When moving from your climbing aid to your Hang-On Tree Stand, step down from the aid to the stand as shown in Fig. 6. Cautiously put your weight on the stand's platform. The additional weight will create tension on the tree attachment strap and cables.

⚠ WARNING

DO NOT LIFT THE FOOT PLATFORM WHILE THE STAND IS IN USE. LIFTING THE FOOT PLATFORM COULD CAUSE YOUR STAND TO SHIFT, RESULTING IN SERIOUS INJURY OR DEATH. YOU MUST ALSO WEAR A SAFETY HARNESS AT ALL TIMES WHILE THE STAND IS IN USE, INCLUDING CLIMBING AND DESCENDING. FAILURE TO DO SO COULD RESULT IN SERIOUS INJURY OR DEATH.

CAUTIOUSLY put your weight on the stand's platform
The additional weight will create tension on the tree strap and cables.

DETAILED BUCKLE AND STRAP INSTRUCTIONS

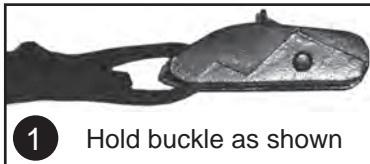

1 Hold buckle as shown

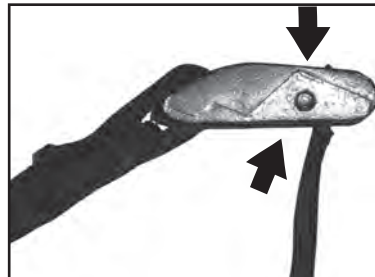

2 Press down on latch and insert strap underneath teeth as shown.



3 Pull strap to desired length.

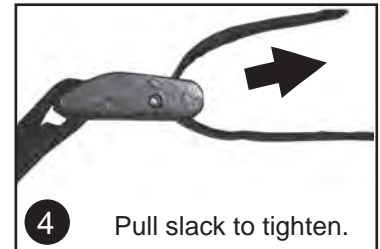

4 Pull slack to tighten.

BACKPACK ASSEMBLY INSTRUCTIONS

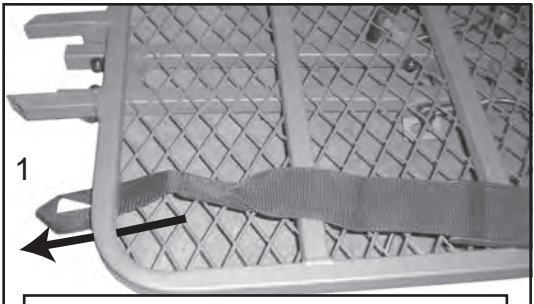

1
Insert looped end of backpack strap through mesh near rear of the foot platform.

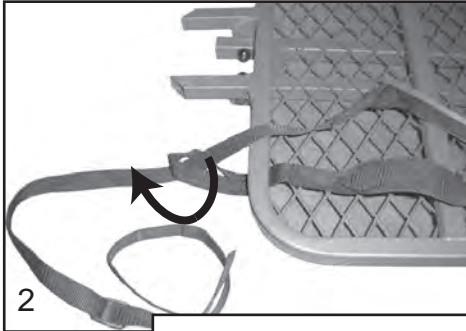

2
Insert other end of strap back through looped end.

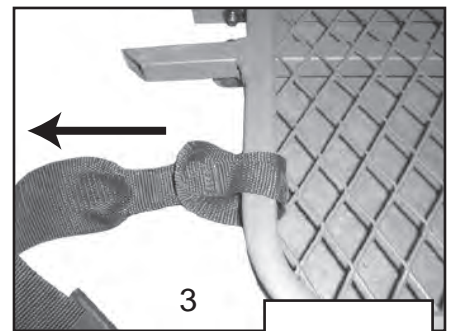

3
Pull tight

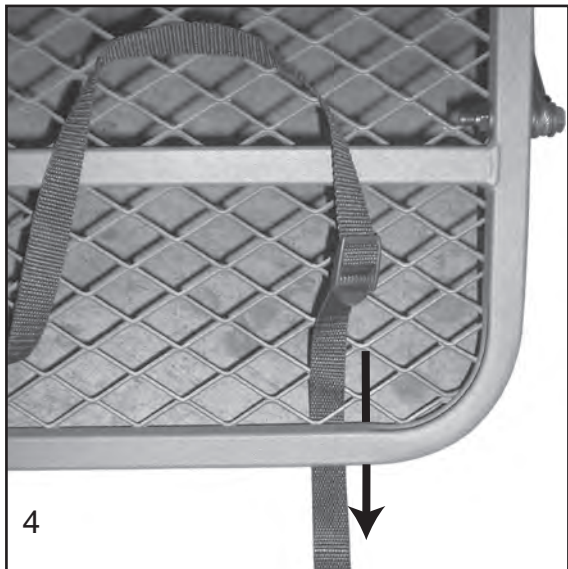

4
Insert loose end of backpack strap through mesh near front of the foot platform.

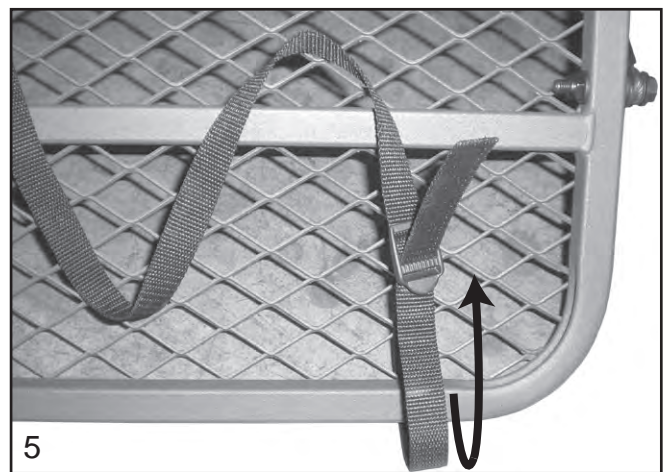

5
Insert end of strap through upper slot of buckle

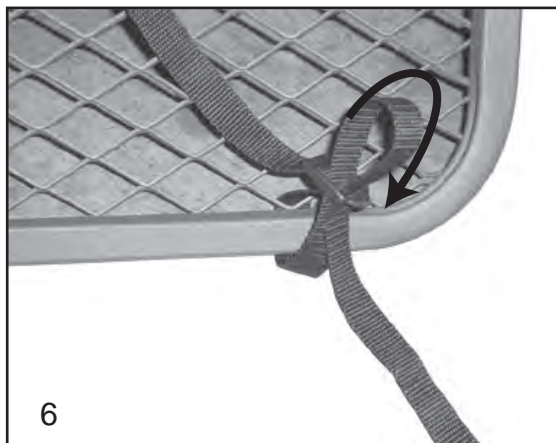

6
Insert end of strap through lower slot (with teeth) of buckle

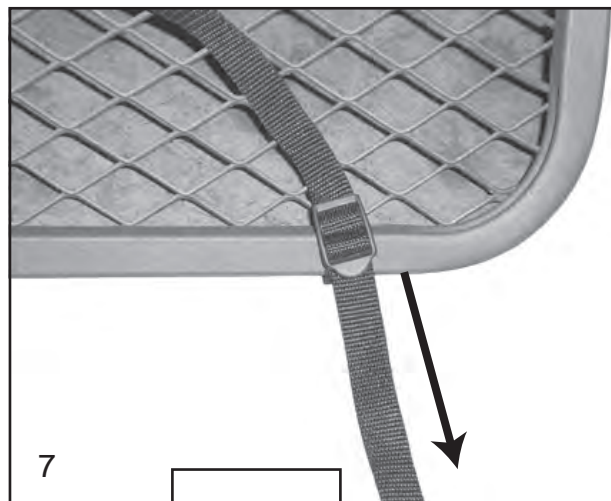

7
Pull tight

Repeat steps 1 through 7 to attach the other strap to the foot platform