

OUTPOST ELITE KIT

MODEL: HEH00591

• Tree Size: 9"-18" Diameter

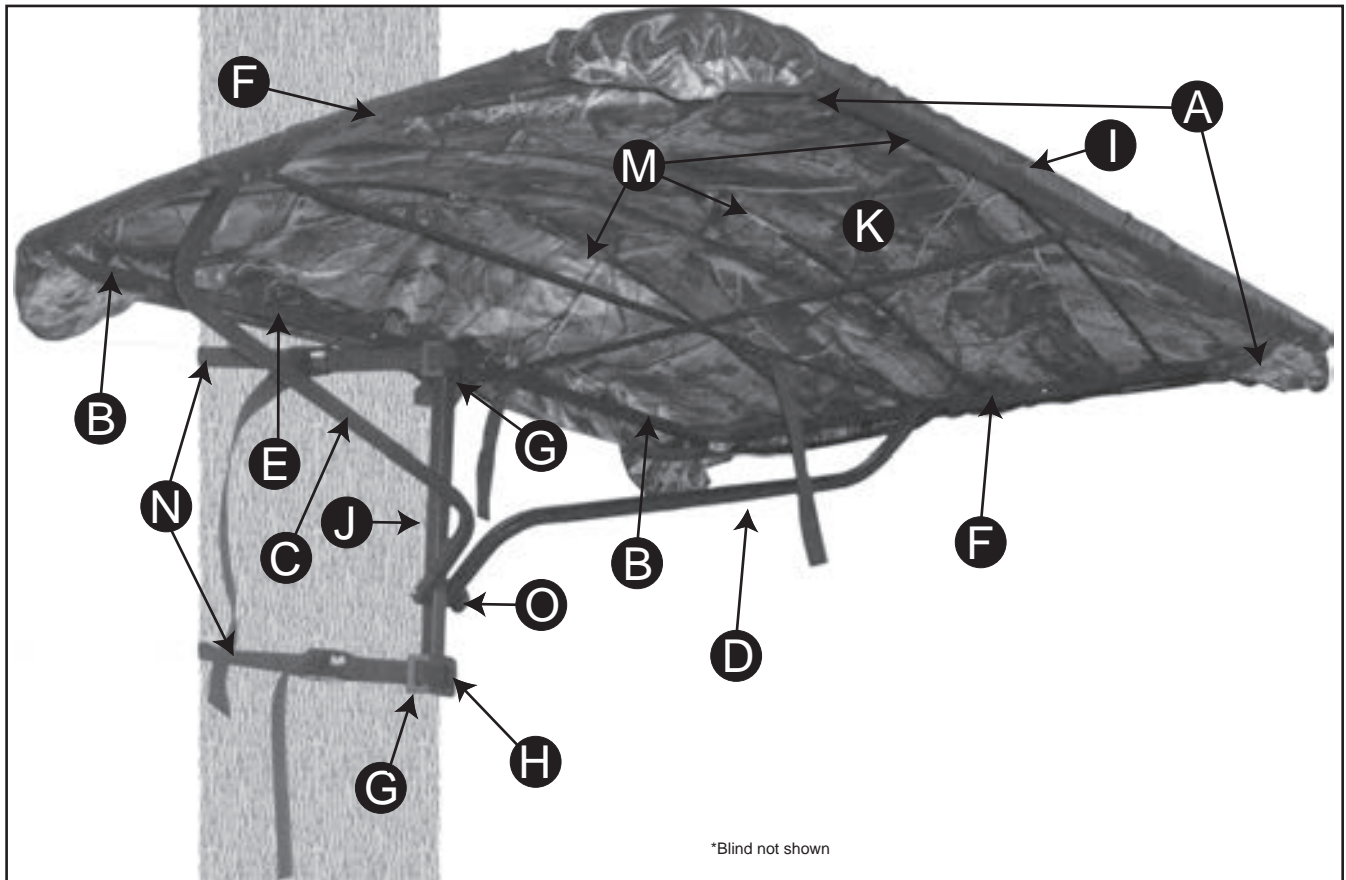

Warning

Every year serious injury and even death occurs from hunting related falls. To ensure your safety, please **COMPLETELY** read and follow this safety manual and **ALL** warning labels **BEFORE** assembling, installing or utilizing this product.

DO NOT USE THIS PRODUCT BEFORE FULLY UNDERSTANDING ALL SAFETY WARNINGS AND INSTRUCTIONS. IF YOU HAVE QUESTIONS, ARE UNSURE ABOUT ANY INFORMATION OR NEED ADDITIONAL INFORMATION CONCERNING YOUR PRODUCT, CONTACT OUR CUSTOMER SERVICE DEPARTMENT AT 1-866-972-6168 OR VISIT WWW.TREESTANDCUSTOMERSERVICE.COM. KEEP AND MAINTAIN THIS SAFETY AND INSTRUCTION MANUAL IN A SAFE LOCATION FOR FUTURE REFERENCE.



Distributed by Primal Vantage Company Inc. 685 Route 10 East, Randolph, NJ 07869

©2012 (rev. 04/12)

SAFETY MUST BE YOUR FIRST PRIORITY WITH THIS PRODUCT

OUTPOST ELITE KIT

MODEL: HEH00591

• Tree Size: 9" - 18" Diameter

PARTS LIST

A	2 Front Frame Corner	Part # DFF-100
B	2 Rear Frame Corner	Part # DRF-100
C	1 Left Rail Support Brace	Part # RK-1015
D	1 Right Rail Support Brace	Part # RK-1020
E	1 TopTree Brace	Part # DTB-510
F	2 Side Brace	Part # RK-1010
G	2 Bracket	Part # DB-1005
H	1 Bottom Tree Brace	Part # DTB-500
I	1 Front Brace	Part # RK-1025
J	1 Vertical Support	Part # RK-1040
K	1 Roof Cover	Part # DBC-583
M	3 Pole	Part # DTP-100
N	2 Buckle Strap	Part # CB-100
O	1 M10 Knob	Part # 1600
P	1 Skirt	Part # DST-583
55	2 M12x55mm Bolt	Part # 1255
40	2 M10x40mm Bolt	Part # 1040

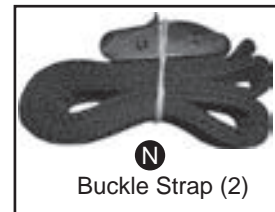
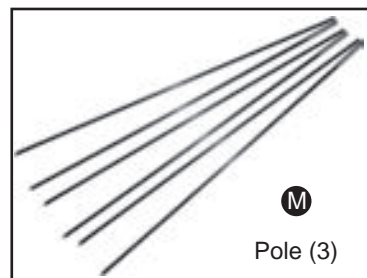
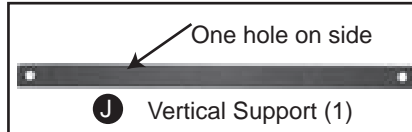
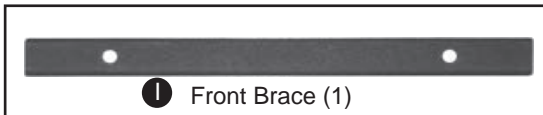
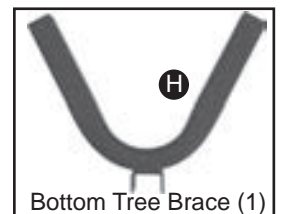
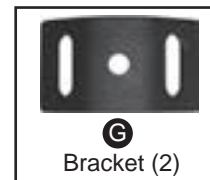
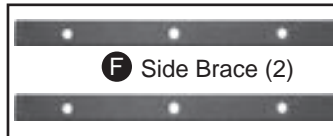
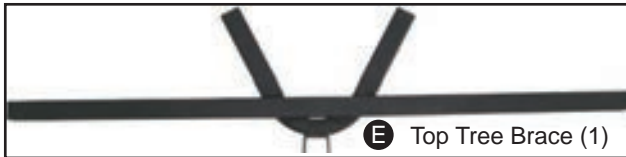
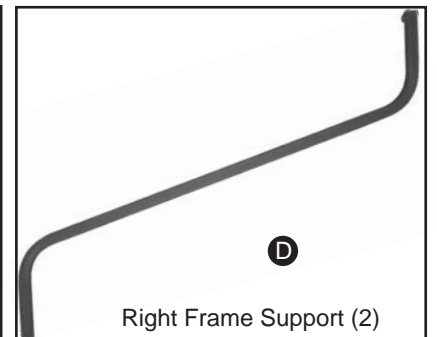
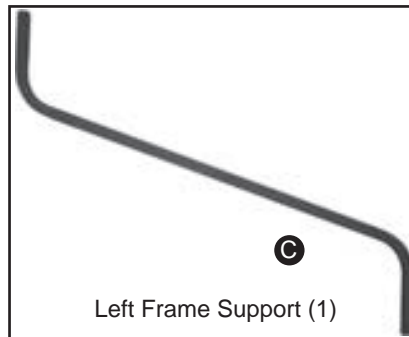
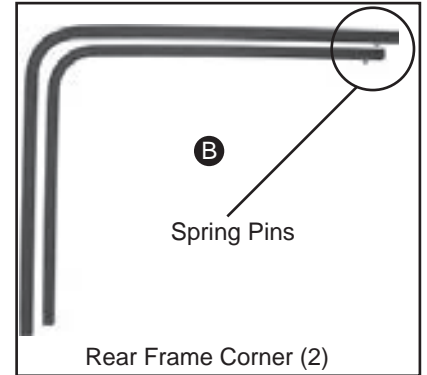
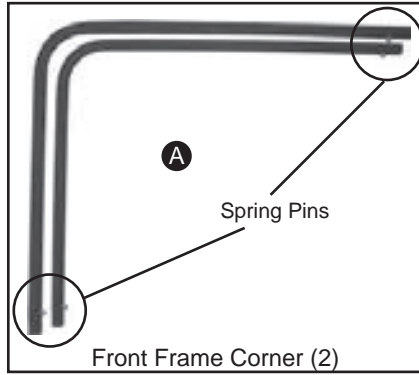

ROOF KIT HARDWARE BLISTER PACK



FIELD & STREAM™
1871

Distributed by Primal Vantage Company Inc. 685 Route 10 East, Randolph, NJ 07869

CUSTOMER SERVICE DEPARTMENT 1-866-972-6168

WWW.TREESTANDCUSTOMERSERVICE.COM

©2012 (rev. 04/12)

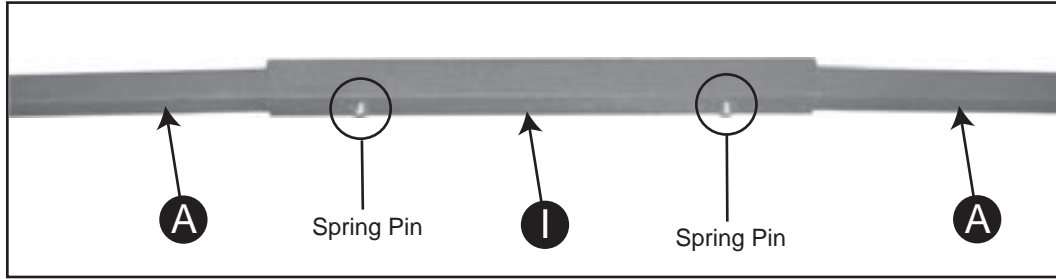

1. Slide Front Brace **I** onto Front Frame Corner **A**.

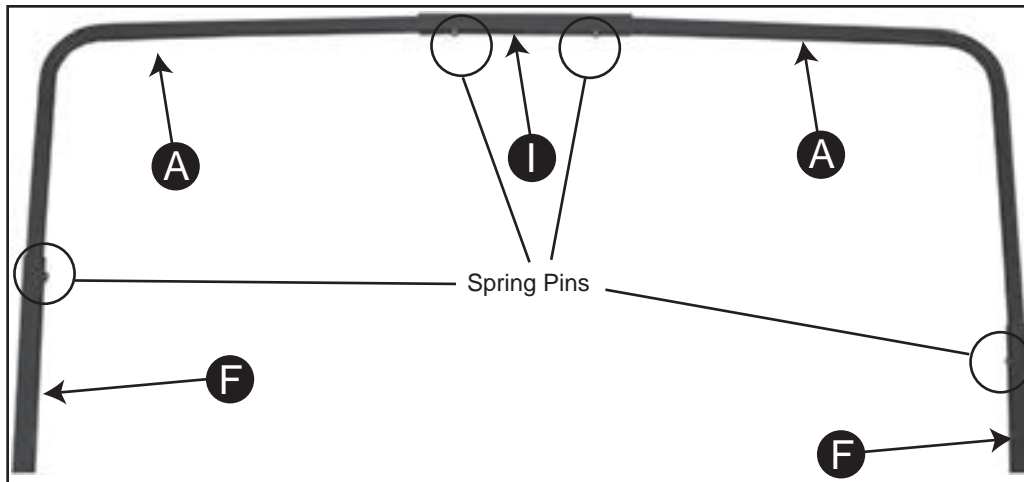

2. Slide each Side Brace **F** onto the other end of Front Frame Corner **A**. There are three holes on each side brace that **MUST** be facing the inside of the frame. **SEE CLOSEUP**

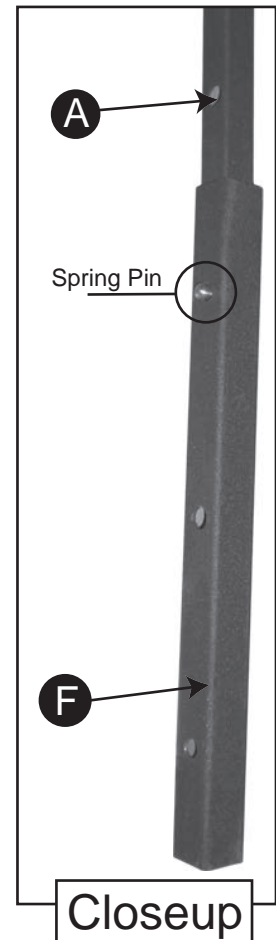

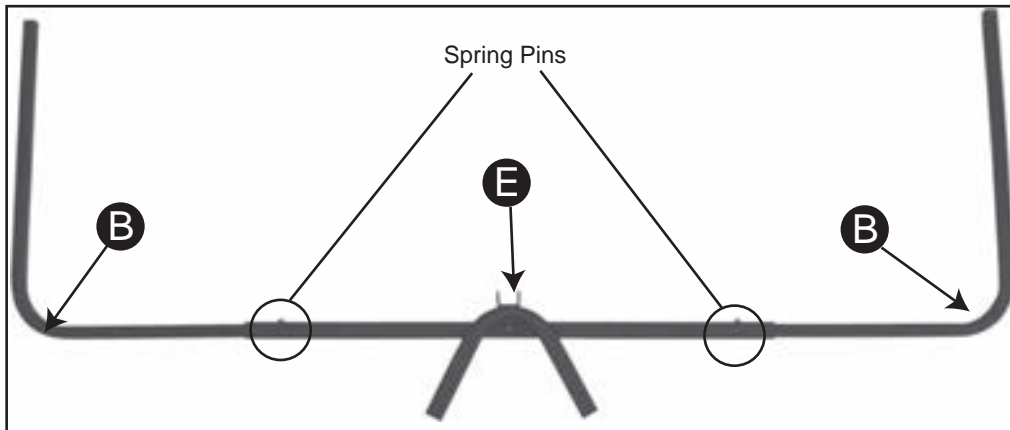

3. Slide each Rear Frame Corner **B** into Top Tree Brace **E**.
The "U" part of the brace **MUST** be on top of the frame.
SEE CLOSEUP

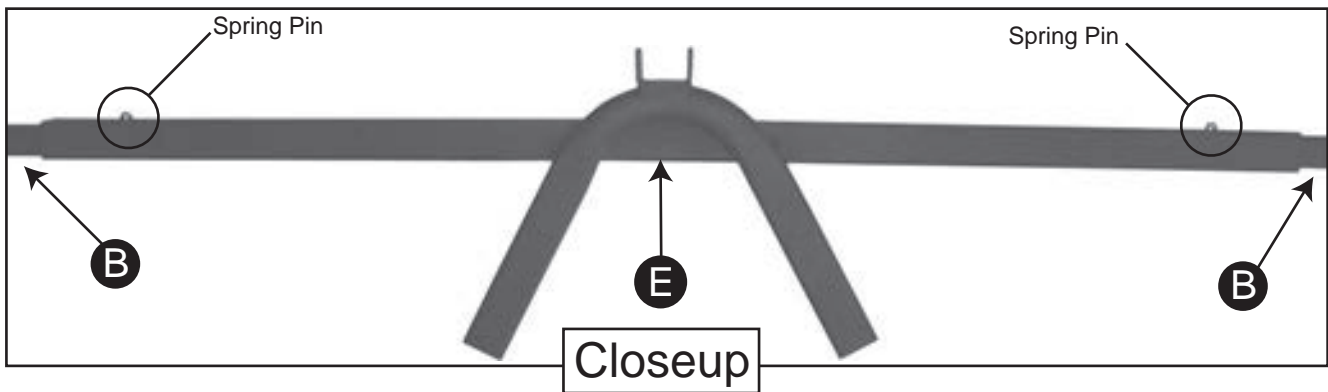

4. Slide each Rear Frame Corner **B** into Side Braces **F**.

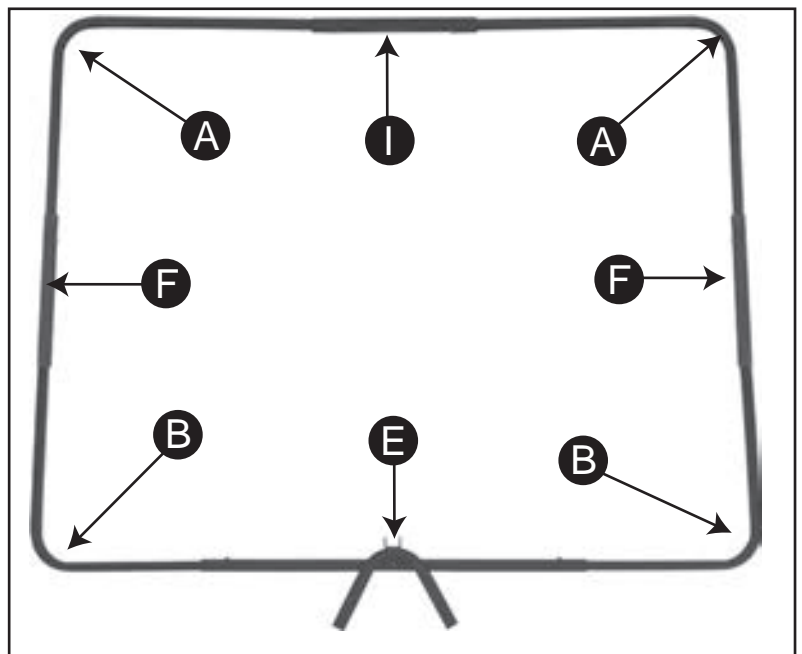

NOTE: ALL WASHERS ARE AGAINST THE BOLT HEAD AND THE NUT UNLESS STATED OTHERWISE

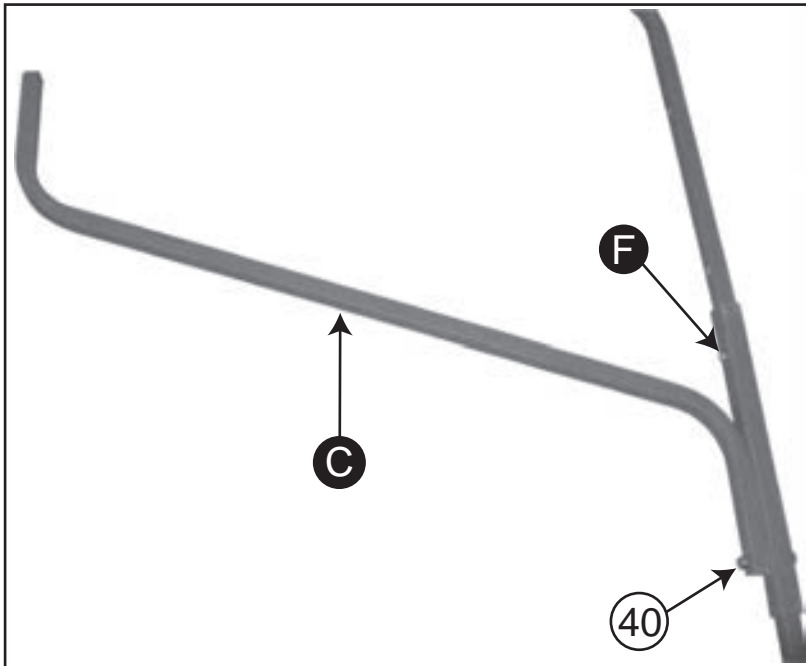

5. Attach Left Frame Support **C** on the Right Side Brace **F** using **1-M10x40mm bolt**. (When you install it on the tree it will be on the left side.)

6. Attach Right Frame Support **D** (the one with the nut on it) on the Left Side Brace **F** using **1-M10x40mm bolt**. (When you install it on the tree it will be on the right side.)

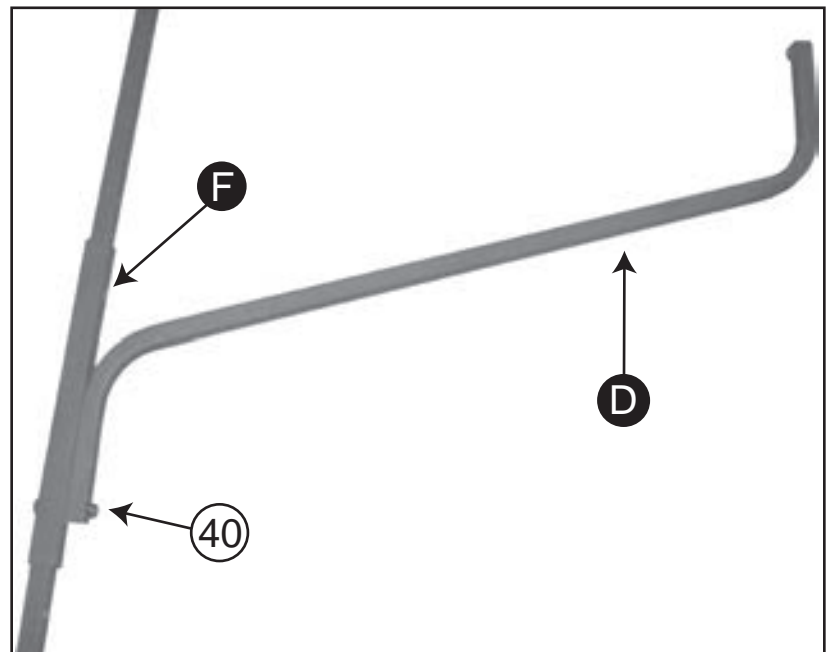

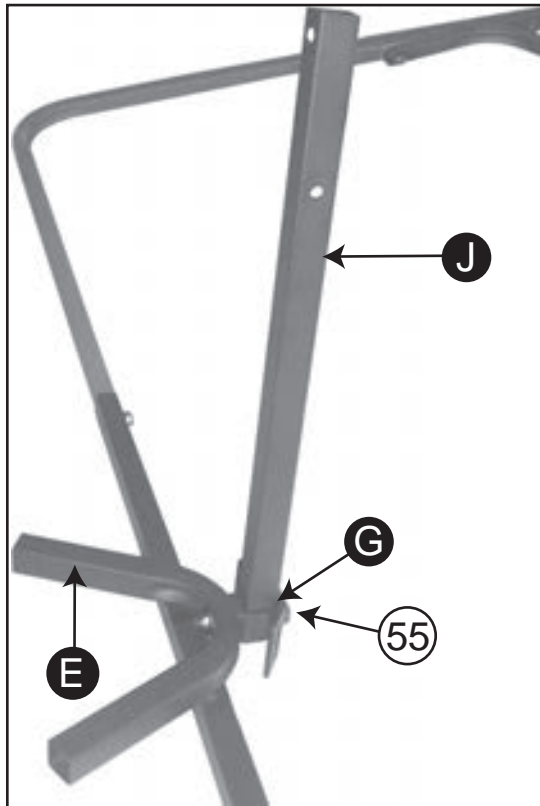

NOTE: ALL WASHERS ARE AGAINST THE BOLT HEAD AND THE NUT UNLESS STATED OTHERWISE

7. Attach Bracket **G** to Vertical Support **J** then attach to Top Tree Brace **E** with 1-M12x55mm bolt.

Insert 1-M12x55mm bolt with washer through the bracket, insert the bolt through the vertical support, then insert the bolt through the Top Tree Brace and tighten with the nut.

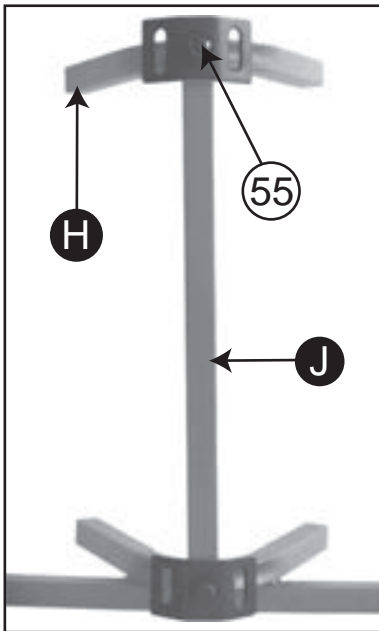

8. Attach remaining Bracket **G** to the top of Vertical Support **J** then attach to Bottom Tree Brace **H** with 1-M12x55mm bolt.

Insert 1-M12x55mm bolt with washer through the bracket, insert the bolt through the vertical support, then insert the bolt through the Bottom Tree Brace and tighten with the nut.

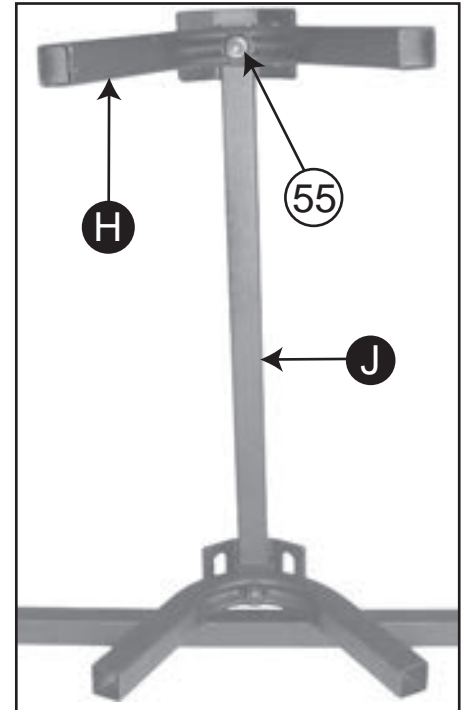

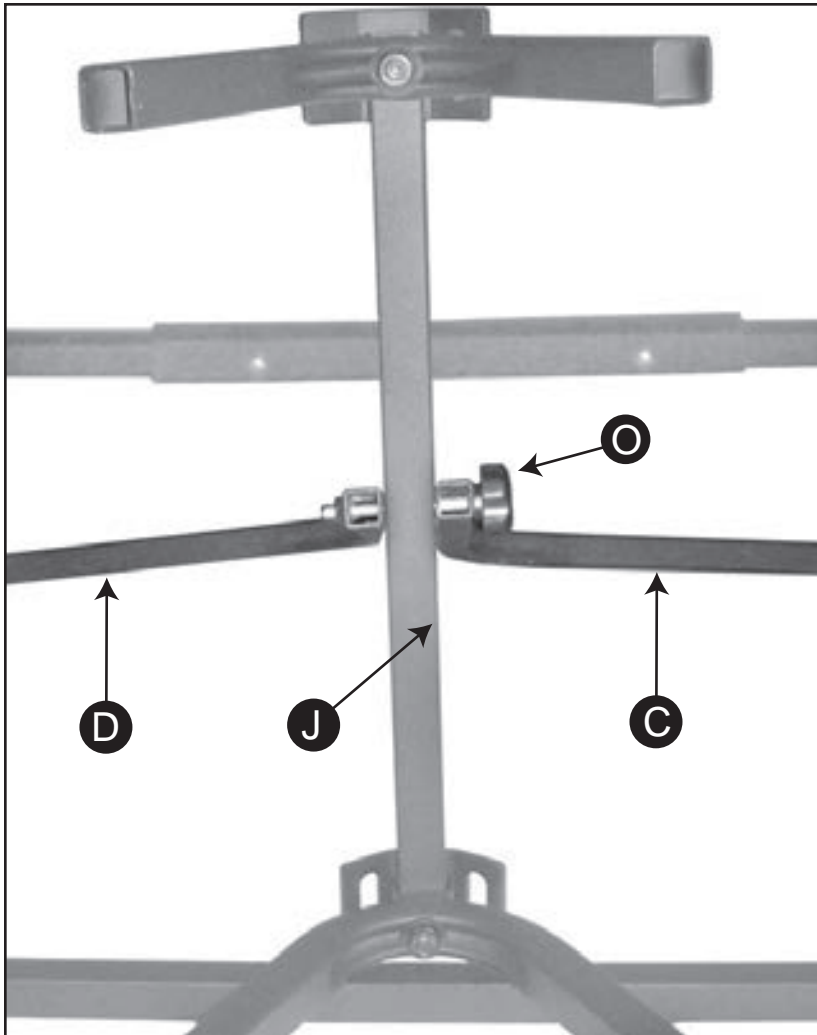

NOTE: ALL WASHERS ARE AGAINST THE BOLT HEAD AND THE NUT UNLESS STATED OTHERWISE

9. Attach Left and Right Frame Supports to Vertical Support **J** using M10 Knob **O**. The Knob will go through Left Frame Support **C** then through Vertical Post **J** then tightened through Right Frame Support **D**. **SEE CLOSEUP**

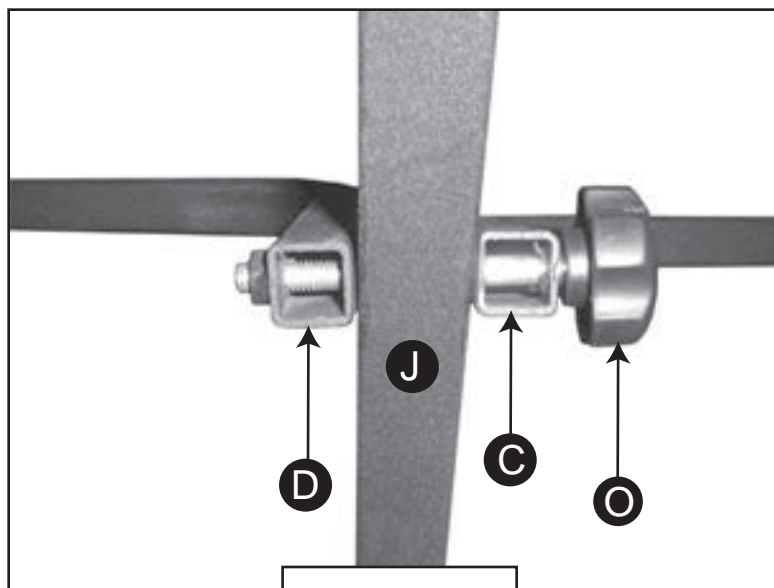

CLOSEUP



10. Insert top Pole **M** into Front Frame Support **A**.
Insert middle Pole **M** into Side Brace **F**.
Insert bottom Pole **M** into Rear Frame Support **B**.

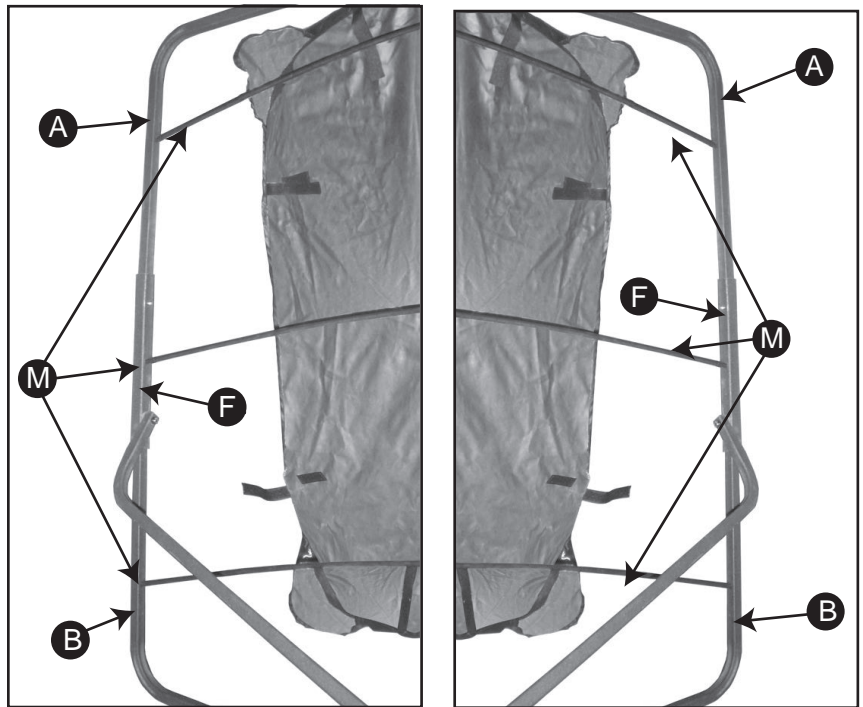

11. Attach Roof/Blind Cover **K** to the assembled roof frame by using the self sticking fabric strips on the front, rear and sides of the frame.

12. Turn the assembled Roof over so the frame is underneath. Pull the Blind Sides out so the camo is on the outside.

Roll up the Blind Sides and tie them to the attached ties on the Roof.



PRIMAL
VANTAGE CO.

Distributed by Primal Vantage Company Inc. 685 Route 10 East, Randolph, NJ 07869

CUSTOMER SERVICE DEPARTMENT 1-866-972-6168

2012
©2012 (rev. 04/12)

WWW.TREESTANDCUSTOMERSERVICE.COM

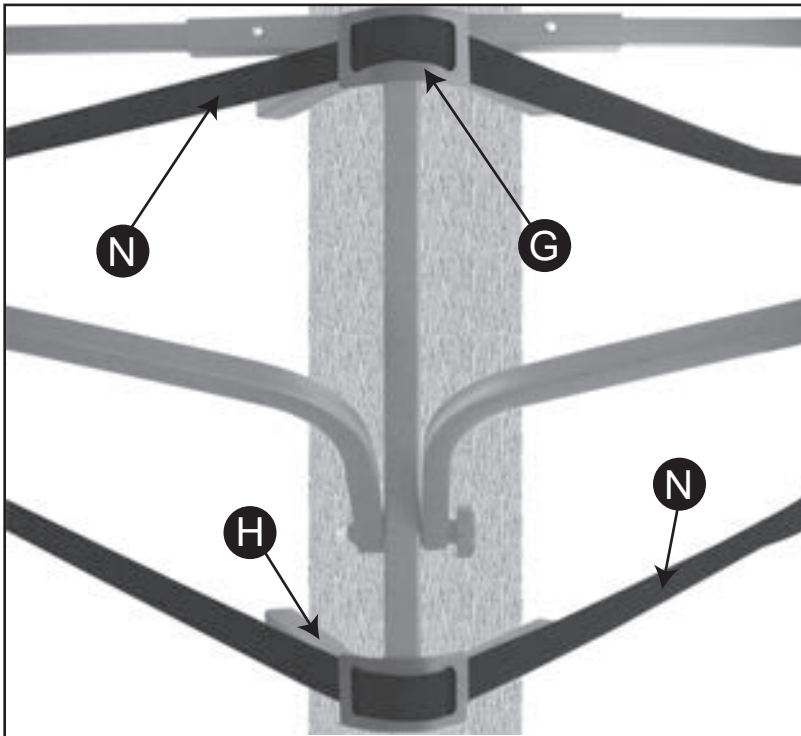

13. Raise the Roof Assembly to the tree using a safe hoist/lift system to 3 feet above the shooting rail of your treestand.

14. Attach the Vertical Support to the tree by using the two Buckle Straps **N**. Insert one end of the strap through Bracket **G** that is attached to Top Tree Brace **E**. Wrap the strap around the tree once and insert the other end into the buckle. **(See Buckle Strap Instructions)**. Pull strap until it is tight against the tree. Attach the other strap to Bottom Tree Brace **H**, by following the above steps and the Buckle Strap Instructions.

⚠ WARNING

You **MUST** use a Hoist system to lift the Roof to the Stand for installation
DO NOT climb the Ladder with the Roof and Blind in Hand

⚠ WARNING

NEVER stand on seat platform to attach roof.
Raise flip-up seat platform to move closer to tree.

BUCKLE STRAP INSTRUCTIONS



Thread the buckle strap through one end of the bracket



Pull strap over the top of the bracket, then through the other side of the bracket.



Pull the strap all the way through so the buckle end is against the bracket. The straps will be attached to the bracket and hang freely until ready to be secured to the tree.



Wrap the Buckle Strap around the back of the tree and insert the strap through the buckle. Make sure that the strap is flat against tree with no slack.

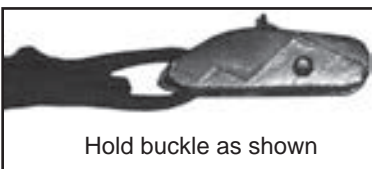

Hold buckle as shown

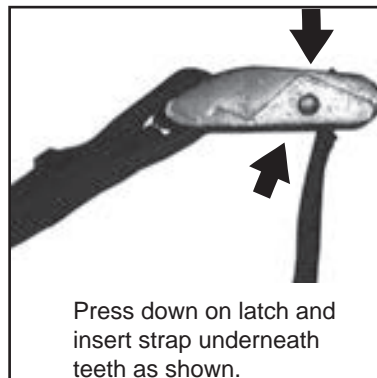

Press down on latch and insert strap underneath teeth as shown.

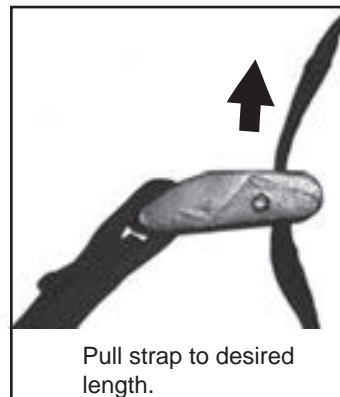

Pull strap to desired length.

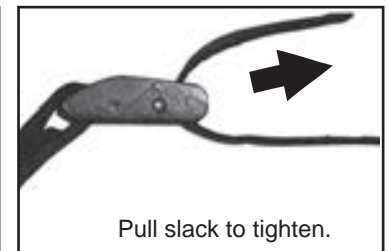

Pull slack to tighten.

