

THE KODIAK

17.5' LADDERSTAND

MODEL: 51036/9414

- Always Wear a Safety Harness with this Product
- Practice Using at Ground Level
- Weight Limit: 300 lbs.
- Tree Size: 9"-18" diameter



Instruction and Safety Manual

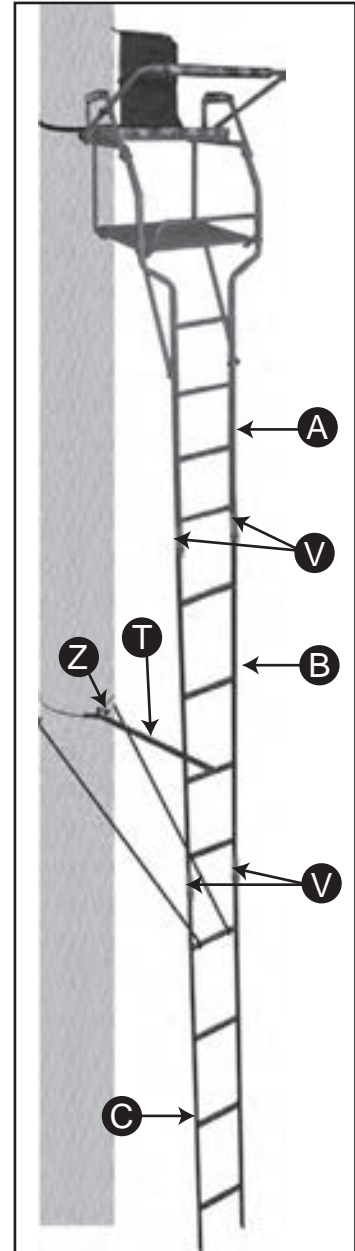
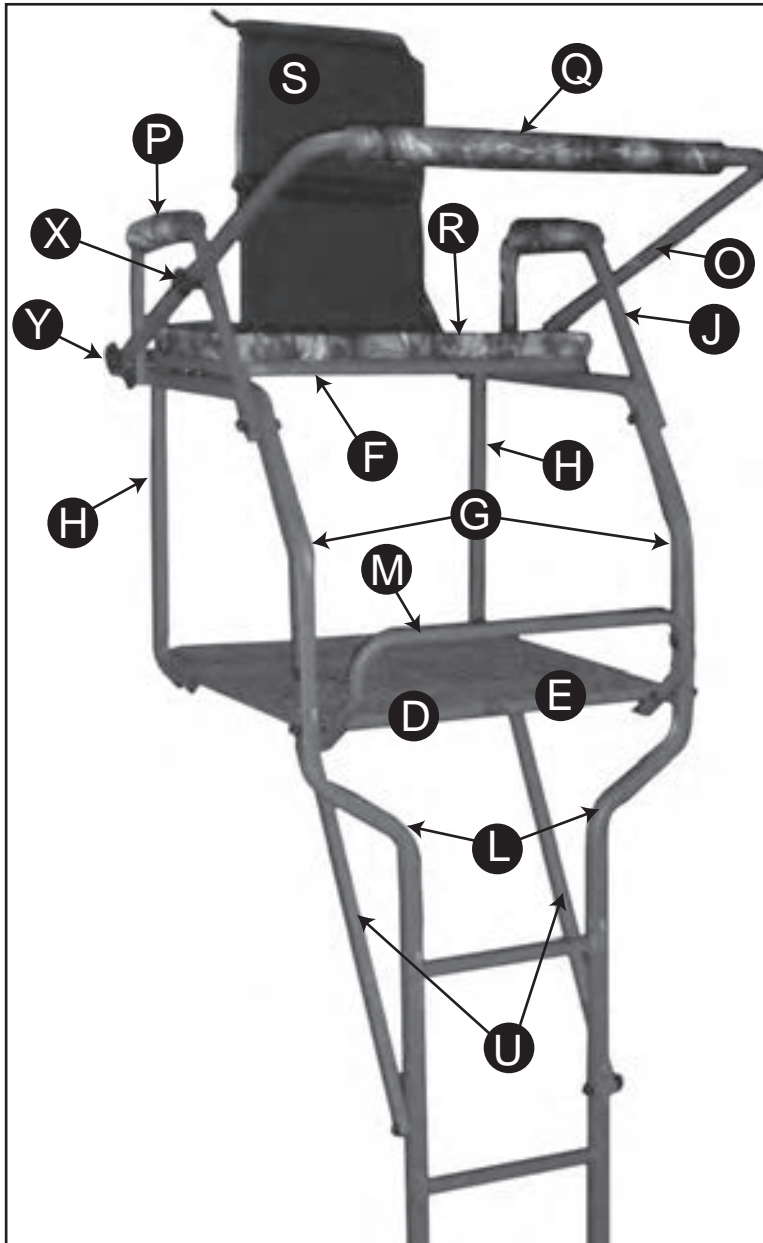

⚠ Warning

Every year serious injury and even death occurs from hunting related falls. To ensure your safety, please **COMPLETELY** read and follow this safety manual and **ALL** warning labels **BEFORE** assembling, installing or utilizing this product.

DO NOT USE THIS PRODUCT BEFORE FULLY UNDERSTANDING ALL SAFETY WARNINGS AND INSTRUCTIONS. IF YOU HAVE QUESTIONS, ARE UNSURE ABOUT ANY INFORMATION OR NEED ADDITIONAL INFORMATION CONCERNING YOUR PRODUCT, CONTACT OUR CUSTOMER SERVICE DEPARTMENT AT 1-866-972-6168 OR VISIT WWW.PRIMALPARTS.COM. KEEP AND MAINTAIN THIS SAFETY AND INSTRUCTION MANUAL IN A SAFE LOCATION FOR FUTURE REFERENCE.



TREESTAND SAFETY WARNINGS

Please read the following instruction manual and warnings labels completely before utilizing this product. Failure to understand and execute the instructions and warnings may result in serious injury or death. In the event of an accident, have a plan for rescue, including the use of devices that may be easily reached while suspended.

ALWAYS read and understand all warnings and instructions and use all safety products provided before each use of this product. Failure to read and understand all warnings and instructions may result in serious injury or death. Contact a Customer Service Representative with any questions you may have.

NEVER exceed total weight limit of **300 lbs.** **DO NOT** use if your combined weight with all of your hunting gear and any accessories exceeds **300 lbs.** Use of tree stand over the weight limit may result in serious injury or death.

DO NOT use this tree stand while under the influence of alcohol, medication or any illegal substances. Use of tree stand while under the influence of any of these substances may result in serious injury or death.

NEVER use this treestand during inclement weather. **DO NOT** use tree stand during thunderstorms, snowstorms, hurricanes, tornadoes or any other weather conditions that include (but not limited to) lightning, icy conditions, or high winds that could create slippery or dangerous situations. End your hunt and return to the ground if inclement weather conditions arise.

NEVER use treestand if you are feeling ill, nauseous, dizzy or if you have a prior condition that could cause a problem. i.e., heart condition, joints that lock-up spinal fusions, etc., or if you are not well rested and alert. Physical ailments can reduce your ability to safely install, utilize, and remove your treestand. Please consult a physician prior to use.

NEVER use this tree stand if you have a history of health problems such as (but not limited to) heart problems, back problems, high blood pressure, impaired vision, equilibrium impairments, are afraid of heights, have been advised by a doctor or physician not to climb. If you are not physically fit, well rested, and alert, or if you have any other physical or mental condition that would impair your ability to properly use this treestand.

NEVER use this tree stand on a tree that is dead, leaning, diseased, loose barked or on a utility pole as the tree may fall, break, or uproot and may result in serious injury or death. **NEVER** rely on a branch for support.

NEVER jump or bounce on the treestand's platform or ladder sections to seat it to the tree. Instead, step firmly on the first rung of the bottom ladder section to set the ladder into the ground before proceeding to climb the ladder.

NEVER transport any of your equipment with yourself while ascending or descending the tree. You will need to have two hands free during ascending and descending for safety. Use a haul line to pull up your firearm (unloaded, chamber opened with safety lock engaged, barrel facing towards the ground), bows, arrows, knives or any other equipment to your tree stand once you have reached your desired hunting height. **ONLY** pull up hunting equipment after the tree stand has been secured to the tree and after you and your harness have been secured to the tree. Prior to descending, lower your equipment on the opposite side of the tree from which you are climbing. Make sure that the unloaded firearm's safety lock is engaged and the gun barrel is pointing towards the ground.

ALWAYS hunt with a plan and a buddy. Before you leave home, let others know your exact location, when you plan to return and who is with you.

ALWAYS carry emergency signal devices such as a cell phone, walkie-talkie, whistle, signal flare, PLD (personal location device) and flashlight with you at all times and within reach even while you are suspended in your harness. Watch for changing weather conditions. In the event of an accident, remain calm and seek help immediately.

ALWAYS inspect the tree stand and the **Fall Arrest System (FAS)** (Harness) for signs of wear or damage **BEFORE** each use. Also inspect to ensure that nuts and bolts are secure. Pay special attention to the harness and straps, guaranteeing that nothing has been frayed or severed. Destroy all products that cannot be repaired by the manufacturer. Contact a Customer Service Representative for replacement parts. The Fall Arrest System **MUST** be discarded and replaced after a fall has occurred.

DO NOT ATTACH YOUR FULL BODY HARNESS TO YOUR TREESTAND.

NEVER modify your treestand in any way by making repairs, replacing parts, or altering adding or attaching anything to it except if explicitly authorized in writing by the manufacturer. Improper installation or adjustment may cause serious injury or death. Remove all contents from box. Inspect for any damaged or missing parts. If any parts are missing or damaged, you must only use certified replacement parts. Using any other replacement parts will void product warranty. **THERE ARE NO EXTRA PARTS.** All parts **MUST** be used to ensure the safety of you and your stand. If you think parts are missing or damaged, **STOP IMMEDIATELY** and contact our Customer Service Department. Using the tree stand with missing or damaged parts may result in serious injury or death. **DO NOT** return this product to the retailer. Contact a Customer Service Representative if you have any missing, damaged or extra parts.

PRACTICE installing, adjusting and using your treestand at ground level prior to using it at an elevated position.

ALWAYS keep instructions (written and video) in a safe place and review before each use. It is the responsibility of the treestand owner to furnish the complete instructions to anyone who borrows or purchases the treestand from you. A safe treestand hunting video has been included. Please view it in its entirety prior to using this product.

NEVER use this treestand for any use other than hunting. Our treestands are designed for hunter's to wear a Full Body Harness. If you are not completely comfortable and confident with your ability to safely install, ascend, hunt and descend using a Full Body Safety Harness and this treestand, **DO NOT PROCEED.**

NEVER use this treestand for trimming trees.

NEVER fall asleep in your stand as you may fall out resulting in serious injury or death.

ALWAYS be sure to retighten all bolts **BEFORE** each new use of treestand.

ALWAYS have a minimum of three people present when installing or removing this treestand.



©2012 (rev. 12/11)

TREESTAND SAFETY WARNINGS

NEVER adjust your stand while in use. Practice the attachment of this treestand at ground level before using in a hunting environment. **ALWAYS** ensure that you and your treestand are safely secured to a healthy tree. Your tree stand **MUST** be attached tightly to the tree and secured in place. If the stand is not secure, it may shift while in use, resulting in serious injury or death.

The Installation Cross Straps and Stabilizer Bar(s) **MUST** be properly installed before each use of the treestand.

ALWAYS inspect every ladder section connection every time you use the stand before you leave the ground. If ladder sections are separating, with the help of at least two other people, lower the stand to the ground, make adjustments, and reinstall.

ALWAYS check the ground below the tree stand to make sure it is firm and level. Sloping ground or uneven terrain (one side of a rock or root) can cause your tree stand to tilt or shift.

ALWAYS maintain three points of contact when climbing the tree stand. (Two feet and one hand **or** one foot and two hands.)

ALWAYS lean forward as you climb and attach your harness to the tree before securing the platform to the tree and stepping onto the platform.

DO NOT leave your treestand outside since weather or animals may cause damage. Tree growth can also cause stress and damage straps and buckles. It must be stored inside when not in use.

NEVER wear jewelry or loose fitting clothing, which can cause hazardous conditions. Clothing may be caught in your equipment and cause you to fall. You must always wear non-slip or rubber boots. Shoelaces must be tucked into your boots. Rings and necklaces **MUST NOT** be worn.

NEVER use this treestand with a second person. The treestand is designed for use by **ONE** person.

NEVER let children play with or use this treestand without adult supervision. This treestand is not a toy. No one under the age of 18 should attempt to use this product without direct adult supervision.

DO NOT use tree stand if any nuts or bolts or parts are loose, bent, or crooked.

ALWAYS know your physical limitations. Don't take chances. If you start thinking about how high you are, don't go any higher. Instead, choose a minimum height that will allow for safe, effective and comfortable hunting.

ALWAYS lean **forward towards the tree** as you climb and attach your harness to the tree **BEFORE** securing the platform to the tree and stepping onto the platform. **NEVER** lean out from the treestand for any reason.

ALWAYS wear a Fall Arrest System (FAS) (Harness) consisting of a full body safety harness after leaving the ground. A TMA Certified Full Body Harness **MUST** always be connected to yourself and the tree during ascending, hunting and descending. Single safety belts and chest harnesses are no longer allowed and should **NEVER** be used. If you are not wearing a Full Body Harness properly attached to the tree, that is protecting you from a fall, **DO NOT leave the ground**. Failure to wear your Full Body Harness may result in serious injury or death. Be aware that falls can occur at anytime after leaving the ground.

ALWAYS read and understand the manufacturer's Warnings, expiration date (if applicable) and instructions on how to use and how to properly adjust the harness. Practice the use of a full body safety harness at ground level in the presence of a responsible adult to experience the feeling of hanging suspended before using in a hunting environment. Failure to follow harness instructions may result in not being able to return to the stand and being suspended in a harness after a fall, or serious injury or possibly death. If the hunting location is unknown by anyone and communication efforts are unsuccessful, you **MUST** have a personal plan for rescue/escape because prolonged suspension in a harness may be fatal. It is important to exercise the legs by pushing against the tree or doing other forms of continuous leg exercises to avoid blood pooling while being suspended. Hunters with varying degrees of physical fitness may require different plans to recover/escape the effects of prolonged suspension. Have a personal plan and practice it in the presence of a responsible adult before leaving the ground. No one escape/rescue plan will work for every hunter on every tree in every circumstance. Only you can determine the best recovery/escape plan for your situation before leaving the ground.

ALWAYS have a suspension relief device on your person and readily accessible while using a harness. These devices allow the user to relieve the load on the lower extremities if suspended in a harness and help maintain circulation in the legs, mitigate suspension trauma (blood pooling) or allow descent to the ground. Several optional products/systems are available that offer self-recovery or self-extraction from a fall when suspended in a harness. Some systems automatically descend the user while others allow user control. One of these products/systems can be considered for use as an additional safety precaution against prolonged suspension and suspension trauma, Be sure to follow the manufacturers' instructions on the safe use of these products/systems.

Hunt from the ground when self-recovery escape is absent. There is time to make a correct decision on what action to take if a fall occurs while wearing a full body harness. It is important to remember "**DO NOT PANIC.**" Remain calm and implement your practiced rescue, relief and recovery plan.

NEVER allow the tether strap to get under your chin or around our neck. The length of the harness tether **MUST** be minimized at all times. It should be adjusted so that it is above the head with no slack (snug) in the sitting position and you should have the minimum amount of slack possible when climbing.

NEVER remove any safety warning stickers from this product.

Safety must be your first priority during the use of this product.

WARNING

DO NOT use this ladderstand without reading and following all warnings and instructions before each use. Failure to do so may result in serious injury or death.

ALWAYS inspect your ladderstand before each use. **DO NOT** use if parts are missing, worn, or damaged.

ALWAYS wear a Full Body Harness while using this stand. Failure to wear a full body harness while using this ladderstand may result in serious injury or death.

DO NOT exceed the ladderstand's 300 lbs. weight which includes your body weight as well as the weight of your clothes and gear. Exceeding the ladderstand's weight limit may cause the treestand to break or fail resulting in serious injury or death.

NEVER stand on treestand seat or gear while using or climbing on any of these parts may cause the treestand to fail resulting in serious injury or death.

NEVER alter, modify, or repair the ladderstand. Do not use any other parts or accessories on the ladderstand.

NEVER use the treestand if you are tired, dizzy, or have any other condition that may impair your ability to climb or descend. The treestand may fall, break, or root anchor may fail resulting in serious injury or death.

NEVER use ladderstand during inclement weather. **DO NOT** use treestand during thunderstorms or any other weather conditions including (but not limited to) lightning, freezing rain, high wind that could create slippery or dangerous conditions.

DO NOT use ladderstand under the influence of alcohol, drugs, or medication. Using ladderstand under the influence of alcohol, drugs, or medication may result in serious injury or death.

NEVER use ladderstand if you have dizzy spells, a heart problem, are afraid of heights, have been advised by a doctor or other health care provider not to climb, or have any condition that would impair your ability to climb up or down or use treestand as it could result in serious injury or death.

NEVER remove or deface ladderstand warning labels. Replacement labels can be obtained from the address below.



©2012 (rev. 12/11)

CHOOSING A SAFE TREE

- **ALWAYS** thoroughly inspect the tree before installing your product. **DO NOT** install your **TREE/LADDER STAND** onto any dead or unsafe tree, telephone or utility pole, structural column, or man-made structure. Doing so may result in serious injury or death.
- **ALWAYS** select the proper tree for use with your **TREE/LADDER STAND**. Select a live straight tree that fits within size limits recommended (minimum tree diameter must be no less than 9 inches and maximum of 18 inches.). **DO NOT** rely on a branch for support.
- **DO NOT** select a tree in the dark or choose a tree in close proximity to a fence. You must not have any stumps or rocks beneath your tree.
- **NEVER** use **TREE/LADDER STAND** on a tree that is dead, diseased, leaning or on wet and uneven ground as the tree may fall, break or uproot.
- Your tree must not be wet, icy or slippery or on wet, swampy, or loose ground that allows the tree to be unstable. Check the ground under **TREE/LADDER STAND** to ensure it is firm and level.
- Be sure you have a level stand platform. Your tree must not lean or have any irregular shape.
- Tree must not have any loose or scaly bark or excessive vines, nails, screws, or any other sharp objects protruding that may sever webbing on product. Any surrounding trees must not lean or have dead limbs that may fall onto you or your product.
- **NEVER HURRY!! HURRYING CAUSES ACCIDENTS!!** While climbing a **TREE/LADDER STAND**, make slow, even movements no more than ten to twelve inches at a time. Make sure you have proper contact with tree and/or **TREE/LADDER STAND** every time you move. On ladder tree stand, **ALWAYS** maintain three points of contact with each step and **ALWAYS** lean forward as you climb.

Several treestands are equipped with a footrest, armrests and/or shooting rail. Neither the footrest, armrests nor the shooting rail have been designed to support a user's weight. Under **NO** circumstances should you place more than fifteen (15) pounds of weight on these structures. Doing so will put the user in serious risk of injury or death.

PROPER CARE AND MAINTENANCE:

- Inspect for defects (damage, rot, corrosion, cracks, freezing, excessive heat, etc.) before every use is required. Do not use if damage is detected or suspected.
- We recommend replacing all hardware/cables/nuts/bolts/clips on your tree stand every two (2) years or sooner if inspection finds it necessary. Use only Primal Vantage approved replacement straps and parts. Use of any other straps or parts, will be viewed as a modification to the product. Any modification will void the warranties and relieve Primal Vantage from all liabilities. Failure to follow these instructions may result in serious injury or death.
- By registering your product, you may be enrolled in our discount program. You may receive a 20% off coupon for our website store, www.primal-store.com to purchase replacement parts in the future.
- **DO NOT** overtighten the hardware. **DO NOT** use a socket wrench. This can lead to structural damage and may negatively affect the performance of your stand. Failure to follow these instructions may result in serious injury or death.



THE KODIAK

17.5' LADDERSTAND

MODEL: 51036/9414

- Always Wear a Safety Harness with this Product
- Practice Using at Ground Level
- Weight Limit: 300 lbs.
- Tree Size: 9"-18" diameter

AMERISTEP®

Quality Hunting

Parts List

A	1 Top Ladder Section	Part # OL-510
B	1 Middle Ladder Section	Part # OL-511
C	1 Bottom Ladder Section	Part # OL-512
D	1 Left Foot Platform	Part # OLP-519
E	1 Right Foot Platform	Part # ORP-519
F	1 Seat Platform	Part # OSP-519
G	2 Handle Rail	Part # OHR-519
H	2 Rear Support	Part # ORS-519
J	2 Armrest	Part # OAR-519
K	1 Tree Connection Brace	Part # OTB-519
L	2 Yoke	Part # OYK-519
M	1 Footrest	Part # OFR-519
N	1 Shooting Rail Extender	Part # OSX-519
O	2 Shooting Rail (Female)	Part # OFR-519
P	2 Armrest Cover	Part # WPAC-300
Q	1 Shooting Rail Cover	Part # WPSC-300
R	1 Seat Cushion	Part # OSC-519
S	1 Backrest Cushion	Part # OSC-518
T	1 Stabilizer Bar	Part # WSB-200
U	2 Platform Support	Part # OPS-519
V	4 Sleeve	Part # WS-100
W	2 Shooting Rail Bracket	Part # SRB-100
X	2 Shooting Rail Knob	Part # SRK-500
Y	2 Knob	Part # WK-320
Z	1 Adjustment Knob	Part # AK-100
	2 Installation Cross Strap	Part # ICS-1000
	1 Tiedown Rope	Part # TR-1000
	1 Ratchet Strap	Part # RA-100

Hardware

ⓐ	2 M12x80mm Bolt	Part # 1283
ⓑ	2 M12x65mm Bolt	Part # 1265
ⓒ	8 M12x60mm Bolt	Part # 1260
ⓓ	9 M12x55mm Bolt	Part # 1255
ⓔ	2 M10x35mm Bolt	Part # 1035
ⓕ	1 M12x45mm w/wingnut	Part # 1245W
	4 M10 Quickclips	Part # 1615
	1 Harness	Part # 2012

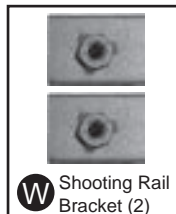
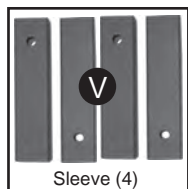
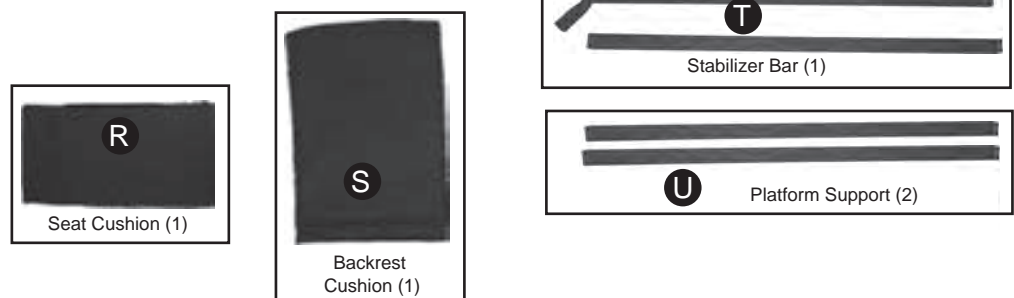
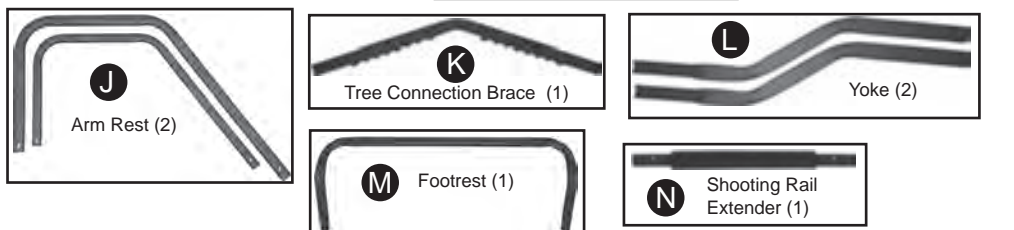
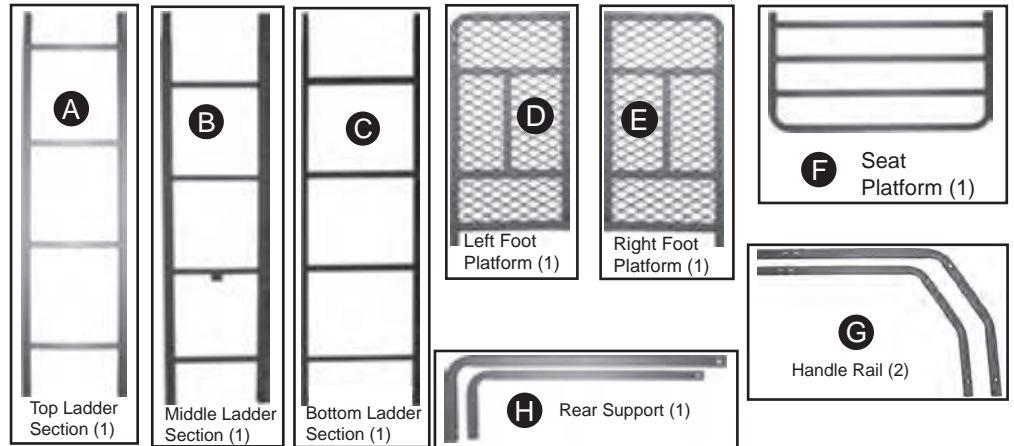

Hardware is layed out as found in blister pack

Hardware Blister Pack

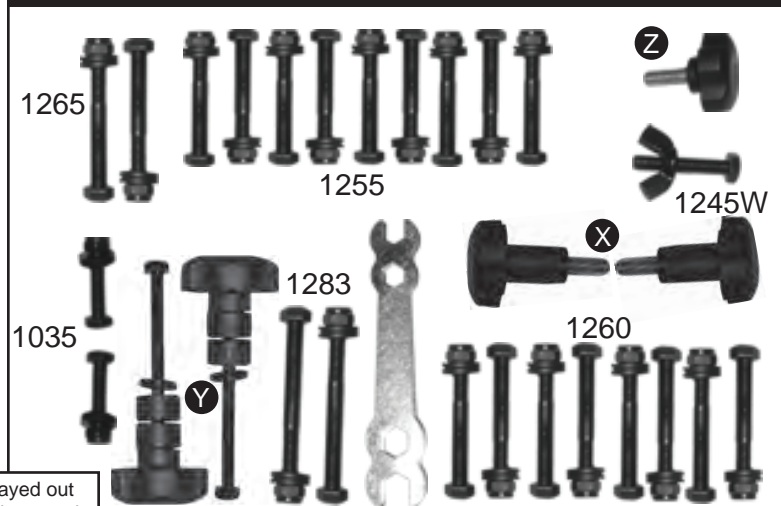

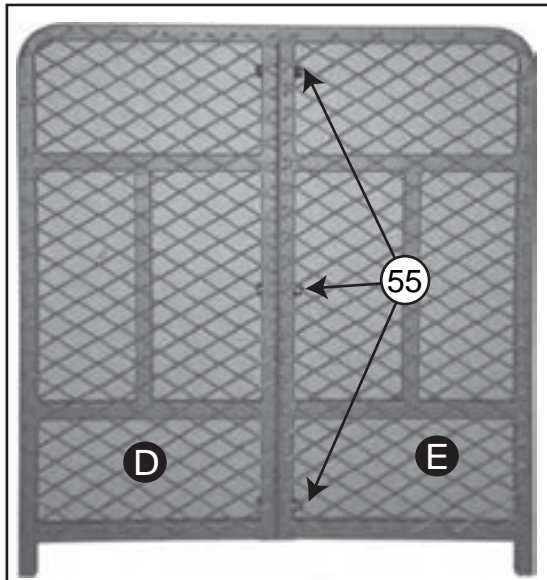

1. Attach Left Platform **D** to Right Platform **E** together using **3-M12x55mm bolts**.

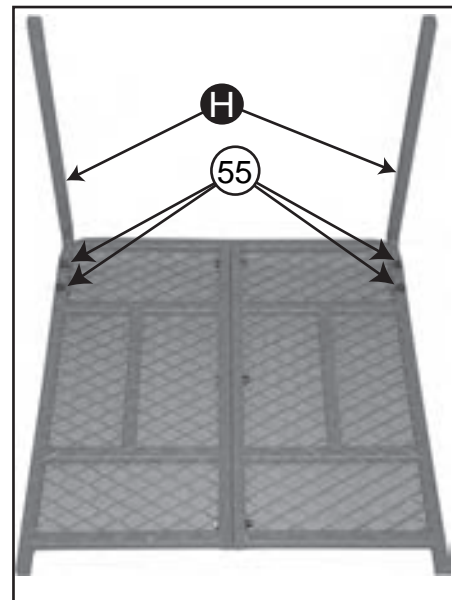

2. Attach each Rear Support **H** to the rear and under side of the assembled platforms using **2-M12x55mm bolts** on each side.

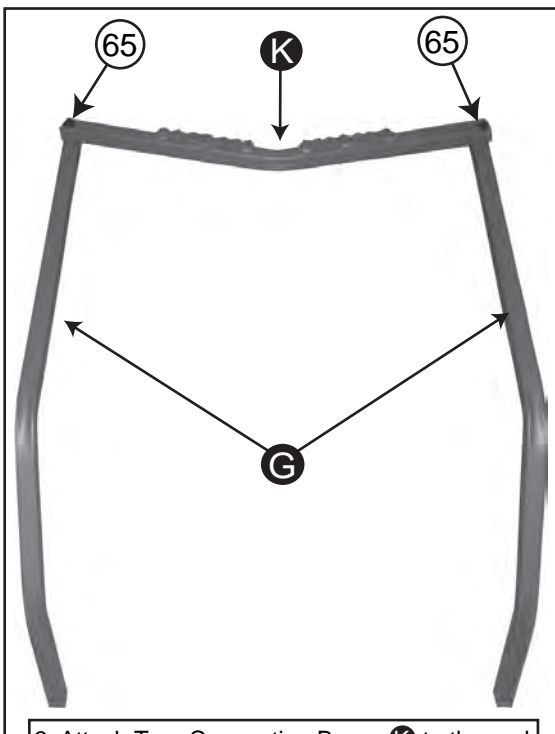

3. Attach Tree Connection Brace **K** to the end holes on the top of each Handle Rail **G** using **1-M12x65mm bolt** on each side.

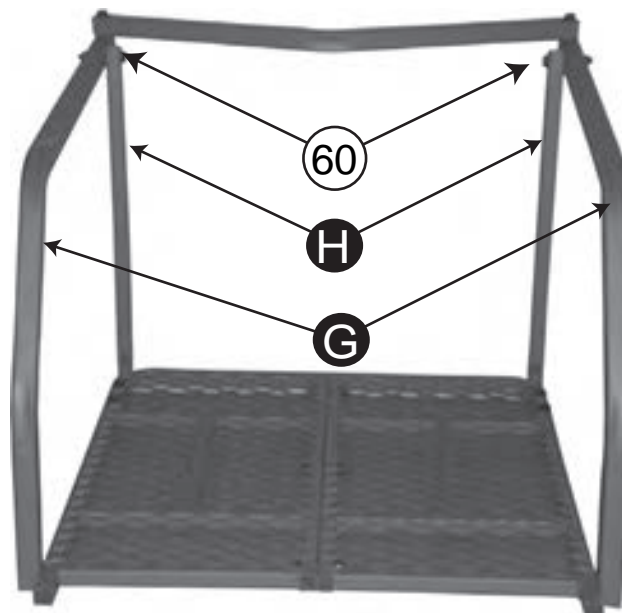

4. Attach Left side of Handle Rail **G** to the outside of Left side Rear Support **H** using **1-M12x60mm bolt** through the outermost hole of the Handle Rail.

The Bolt Head should be on the outside of the frame.

Repeat for Right side.

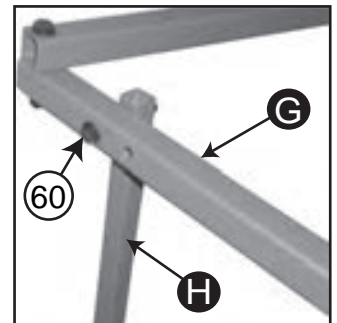

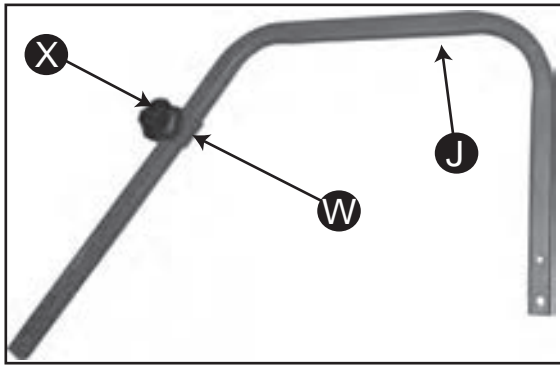

5. Slide Shooting Rail Bracket **W** on Armrest **J**. Attach Shooting Knob **X** into the nut on the bracket.

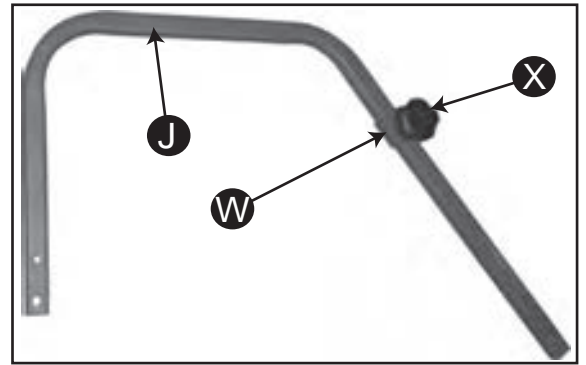

6. Slide Shooting Rail Bracket **W** on Armrest **J** on the opposite side from the other armrest. Attach Shooting Knob **X** into the nut on the bracket.

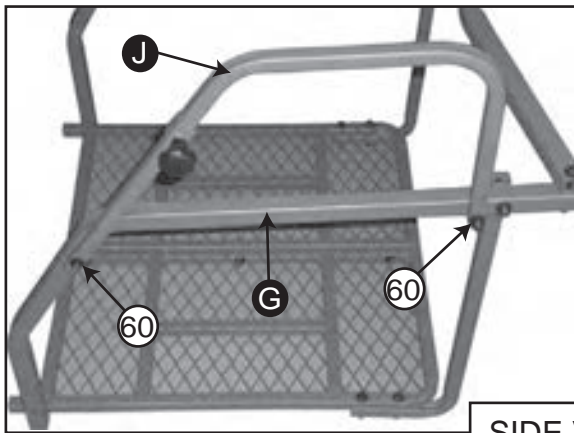

SIDE VIEW

7. Attach the front of Armrest **J** to Handle Rail **G** using **1-M12x60mm bolt**. Attach the rear of Armrest **J** to Handle Rail **G** using **1-M12x60mm bolt**.

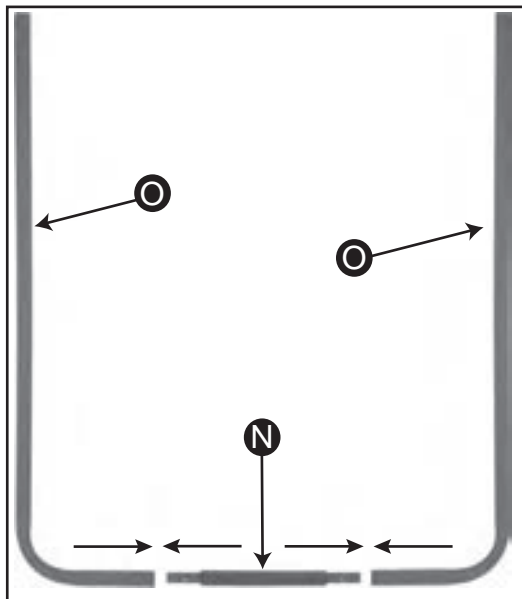
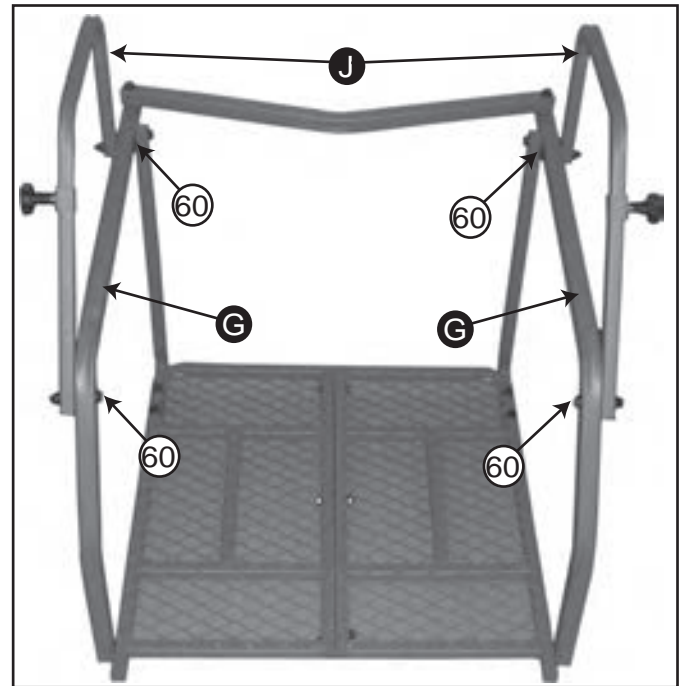

8. Slide Shooting Rail Extender **N** into each half of Shooting Rail **O**.

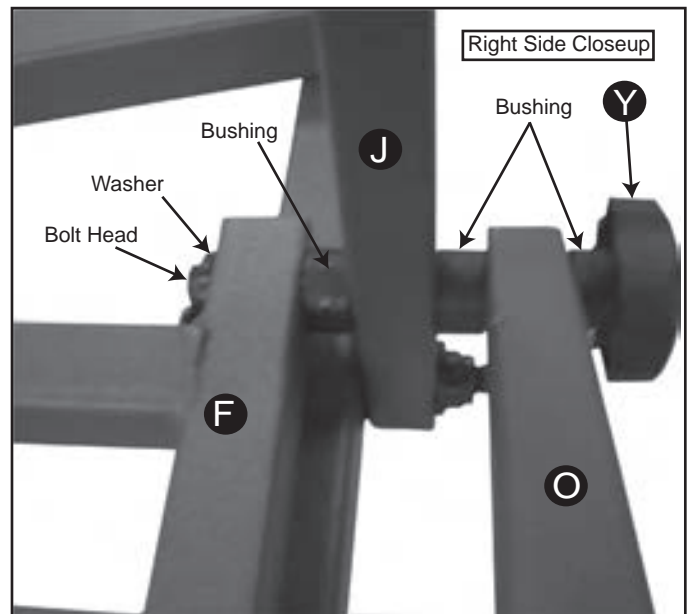
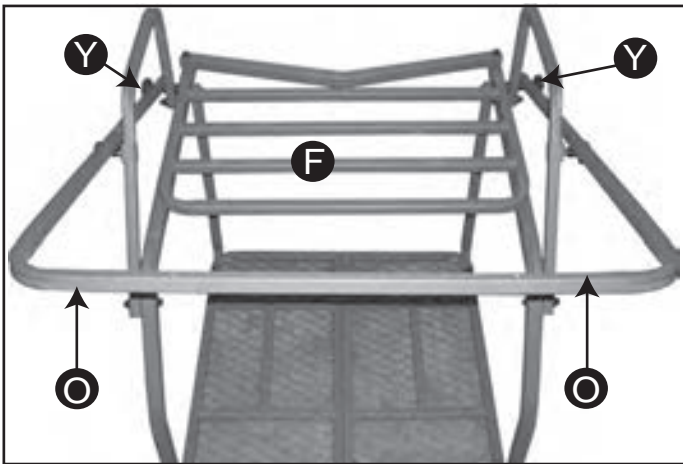

9. Attach assembled Shooting Rail and Seat Platform **D** through Armrests **H** using the Knob **Y**. (See Closeup)

Place Seat Platform **F** on top of Handle Rails **G**. Insert the washer onto the bolt from the knob. Insert the bolt through the hole at the rear of the Seat Platform. Insert the first bushing onto the bolt. Insert the bolt through Armrest **J**. Insert the second bushing onto the bolt. Insert the bolt through Shooting Rail **O** and finally tighten the knob onto the bolt.

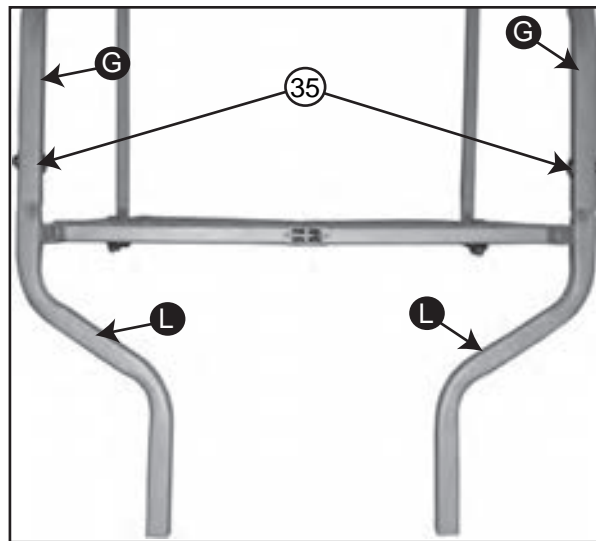

10. Slide Yoke **L** into each Handle Rail **G**. Insert **1-M10x35mm bolt** through each Handle Rail and Yoke to secure in place.

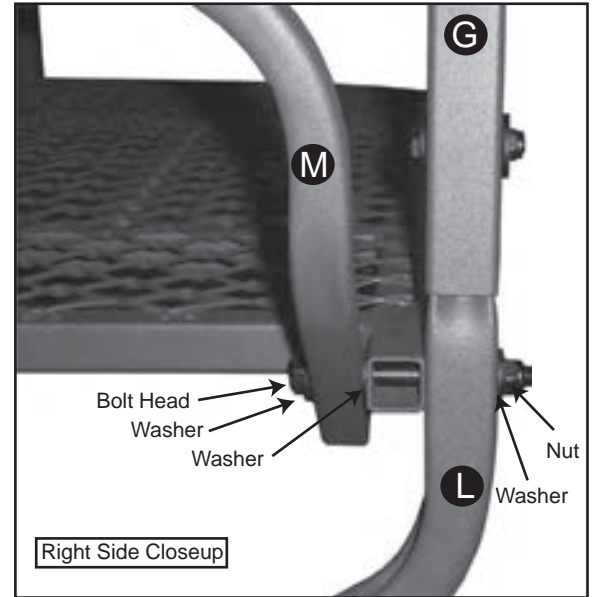
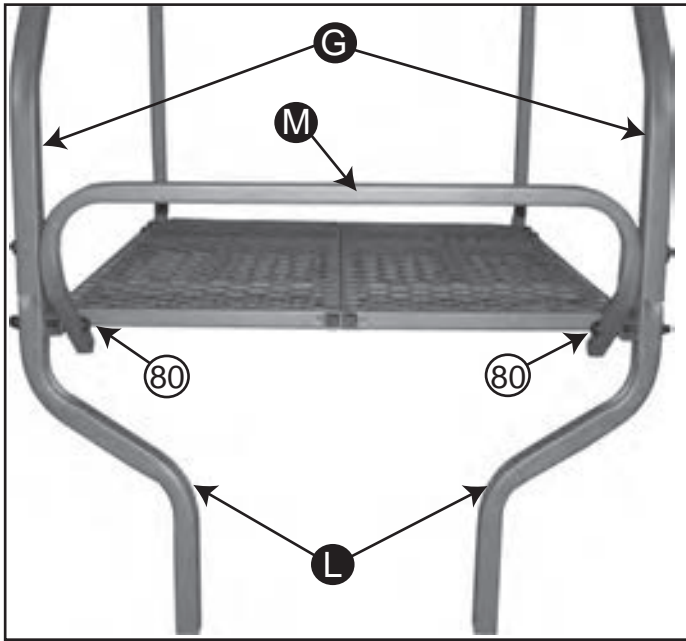

Right Side Closeup

11. Attach Footrest **M** through assembled Foot Platform to Yoke **L** using 1-M12x80mm bolt on each side. (See Closeup to the right).

Insert the washer onto the bolt.
Insert the bolt through Footrest **M**.
Insert the next washer onto the bolt.
Insert the bolt through Foot Platform.
Insert the bolt through Yoke **L**.
Finally insert washer onto bolt and tighten the nut.

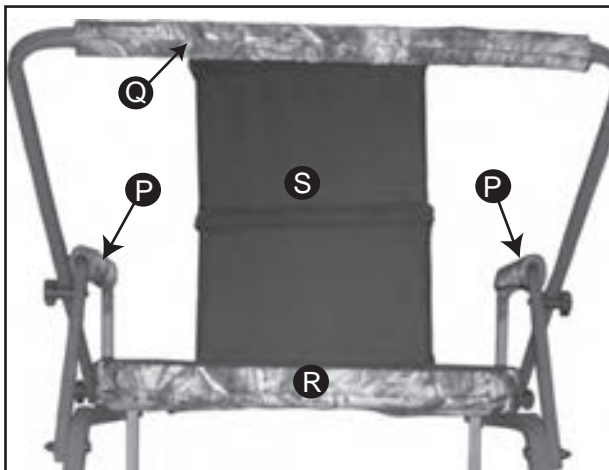

12. Attach Backrest Cushion **S** to Seat Cushion **R**.
Attach Seat Cushion **R** to Seat Platform **F**.
Attach Armrest Covers **P** to Armrests **J**.
Attach Shooting Rail Cover **Q** to Shooting Rail.

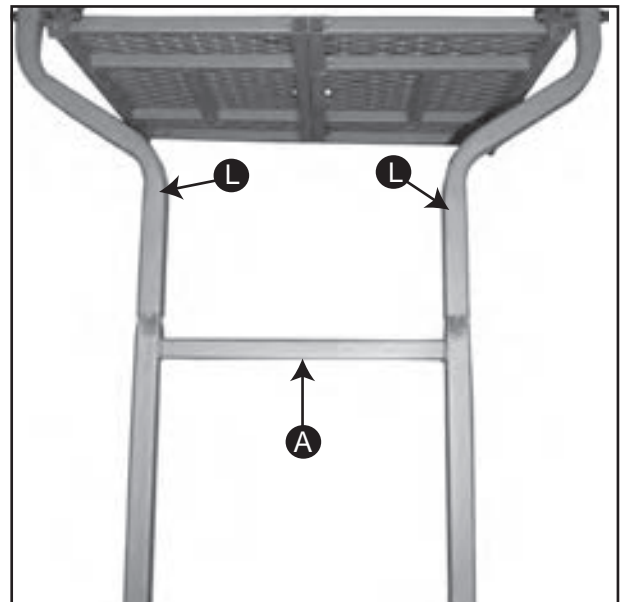

13. Slide Top Ladder Section **A** into Yoke **L**.

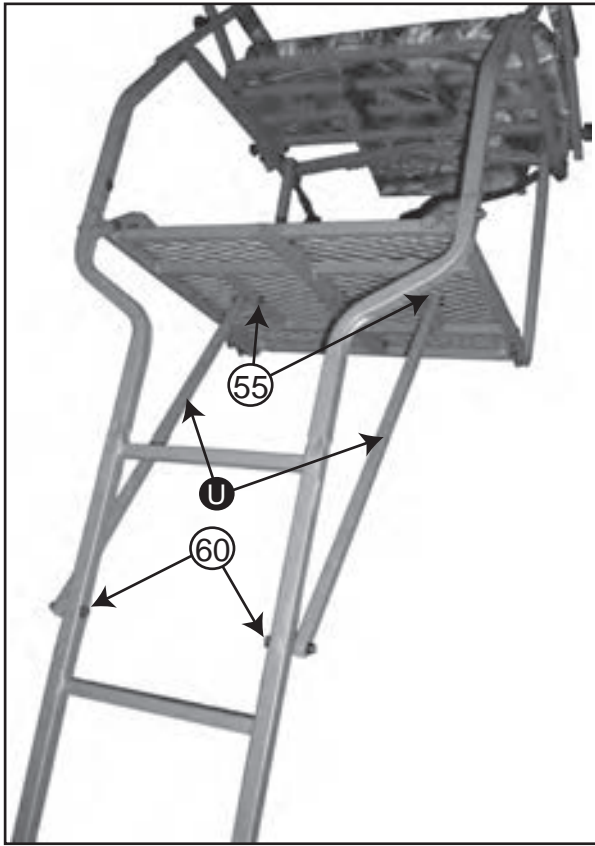

14. Attach the bottom of each Platform Support **U** to the outside of Top Ladder Section **A** using **1-M12x60mm bolt** at each point.

Attach the top of Platform Support **U** underneath Foot Platform using **1-M12x55mm bolt** at each point.

15. Attach Ratchet Strap Assembly to the outermost corners of the Handle Rail where the Tree Connection Brace is attached.
(See Ratchet Strap Instructions)

Attach each Installation Cross Strap just behind the Tree Connection Brace.
(See Installation Strap Instructions)

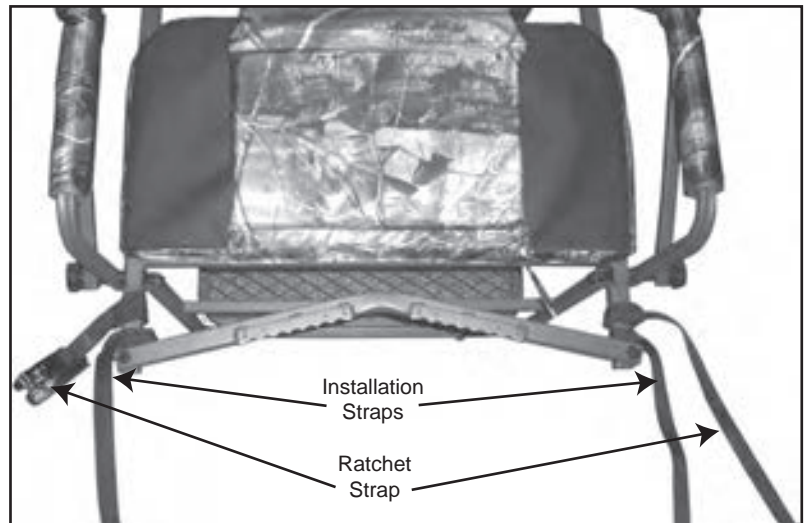

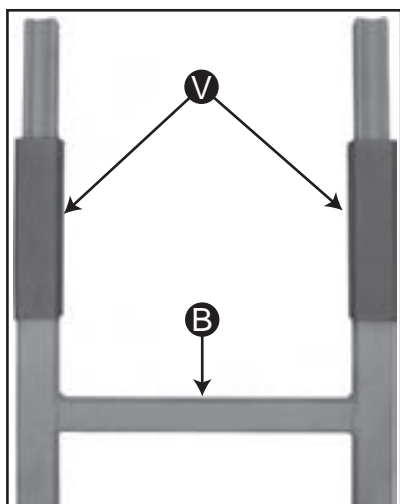

1. Slide Sleeves **V** over the crimps of Middle Ladder Section **B**.

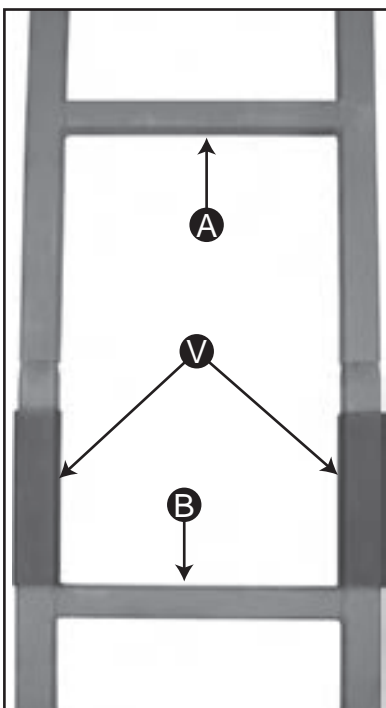

2. Insert Middle Ladder Section **B** into the Top Ladder Section **A**.



3. Slide the Sleeves over the joint where ladder sections are connected.

NOTE

The Bracket on the Middle Ladder Section MUST be facing towards the tree.

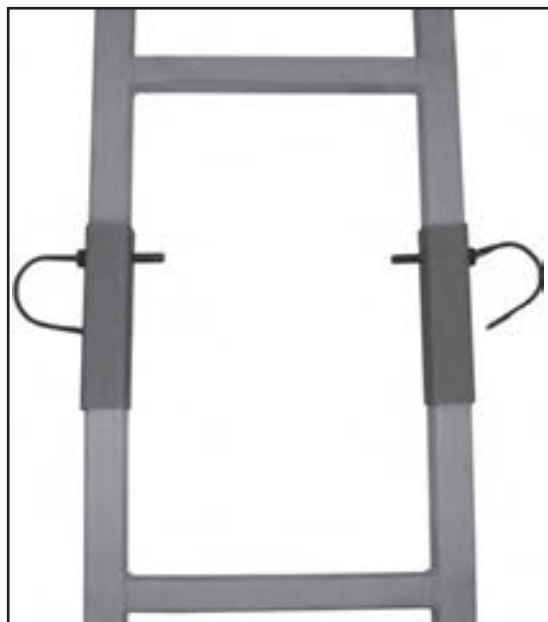

4. Insert 1 - **Quickclip** through the hole on the sleeve, and through the ladder sections on each side of the ladder.

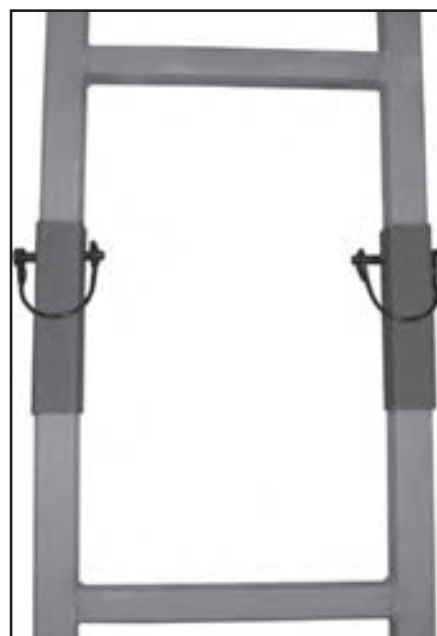

5. Close the quickclip to secure the ladder sections together.

6. Follow these above steps to attach the bottom section to the middle section.



1. Make sure that Ratchet Strap and Installation Cross Straps are properly attached.

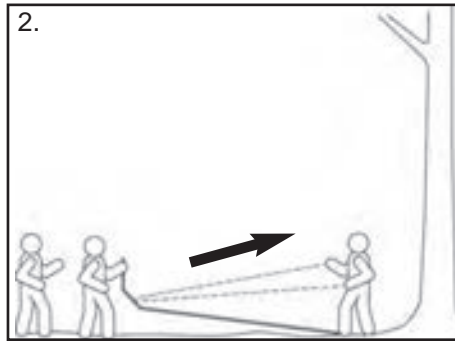

2. Position bottom of stand 4-5 feet from base of tree.

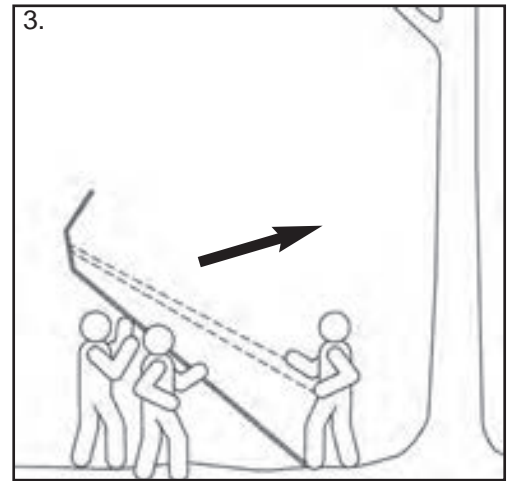

3. One person will stand at the base of ladder with his/her foot on bottom rung while holding installation straps. This will prevent tree stand from sliding. Two people will stand at opposite ends of tree stand, facing Platform and slowly walk tree stand upward using rungs of ladder.

NOTE: Drawings are for illustration purposes only. Drawings may not depict actual product.

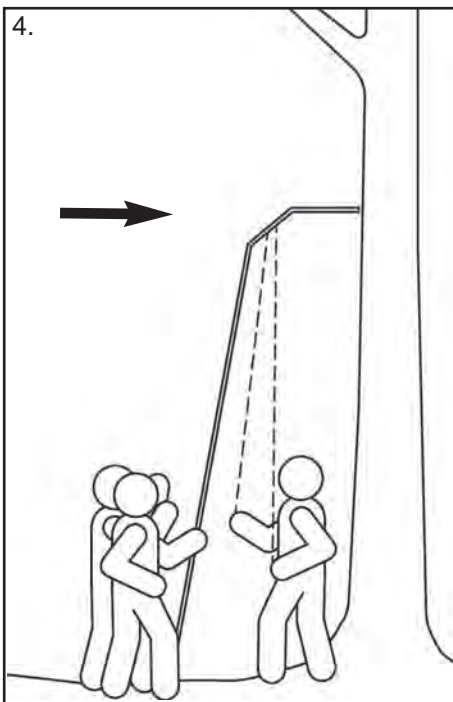

4. As tree stand is being raised, the person holding Installation Straps will pull toward themselves to take up slack. It will steady and ease the weight of stand on the other two people. Continue walking stand upward, until Tree Contact is resting against the tree.

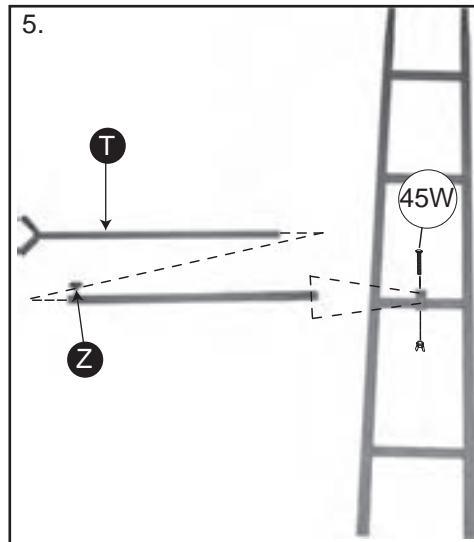

5. Slide the inner part of the Stabilizer Bar into the outer part. Attach Stabilizer Bar **T** to the bracket attached to the third rung of the Middle Ladder Section with **1 - 12x45mm bolt and 1 wingnut**.

Insert the Adjustment Knob **Z** in the Stabilizer bar at the proper adjustment point to the tree.

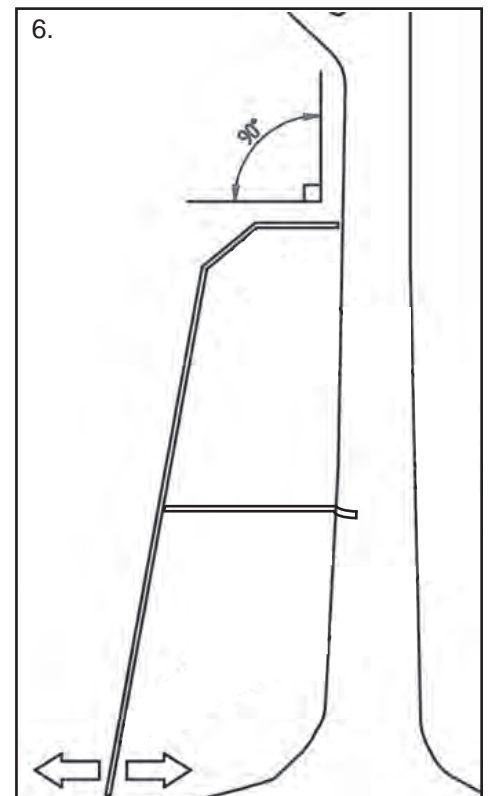

6. Move base of ladder toward or away from tree slightly in order to make Platform as parallel to the ground as possible.

Apply your full weight to the first step so it settles into the ground.

WARNING
DO NOT climb ladder without stabilizer bar installed. Serious injury or death may occur if stabilizer bar is not installed.

WARNING
Stabilizer Bar and Installation Straps **MUST** be secured prior to climbing the Ladderstand. Failure to comply may result in serious injury or death.

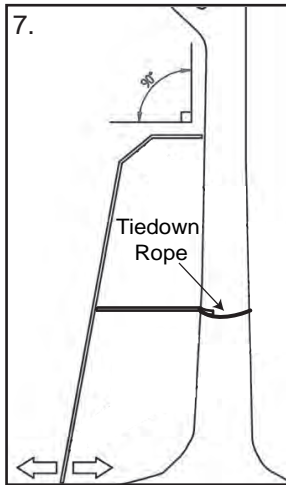

7. Tie one end of Tiedown Rope to the inner part of Stabilizer Bar near the flanged end. Position the Stabilizer Bar against the tree and secure it by wrapping the rope around the back of the tree once and then tie the other end of the rope to the stabilizer bar.

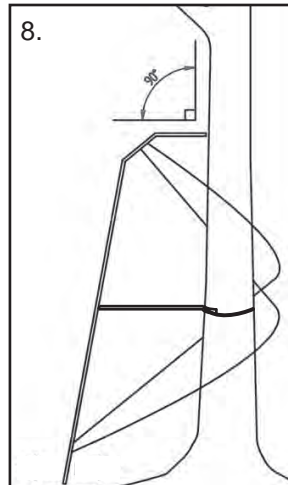

8. Cross Installation Straps behind tree. Attach to the top rung of the bottom ladder section by following the **Installation Strap Instructions**.



9. After the ladder stand has been secured to the tree with the installation straps, and the stabilizer bar has been securely attached to the tree, continue to have two people hold the ladder, climb cautiously up to the platform. Once you reach the top, **IMMEDIATELY ATTACH YOUR SAFETY HARNESS TO THE TREE**. Keep the tether strap above your head.

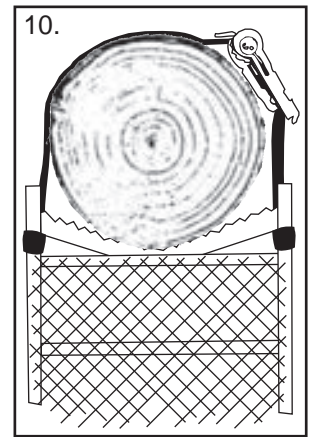

10. Cautiously climb to the top of the treestand. Wrap the strap of the ratchet around the back of the tree and thread it through the ratchet. **(See Ratchet Instructions)**.

⚠ WARNING

DO NOT climb ladder without stabilizer bar installed. Serious injury or death may occur if stabilizer bar is not installed.

⚠ WARNING

Stabilizer Bar and Installation Straps **MUST** be secured prior to climbing the Ladderstand. Failure to comply may result in serious injury or death.

⚠ WARNING

DO NOT sit on seat platform until the ratchet has been secured.

RATCHET INSTRUCTIONS



1

Open ratchet handle flat and insert end of strap through opening.



2

Pull Strap through opening



3

Insert end of strap back through slot in ratchet wheel.



4

Ratchet handle back and forth to tighten strap



5

After strap is tight, close handle to the locked position



6

To release tension, push spring loaded retaining lock and simultaneously pull on strap.

⚠ WARNING **DO NOT** sit on seat platform until the ratchet has been secured.

RATCHET STRAP INSTRUCTIONS

You **MUST** follow these instructions prior to installation

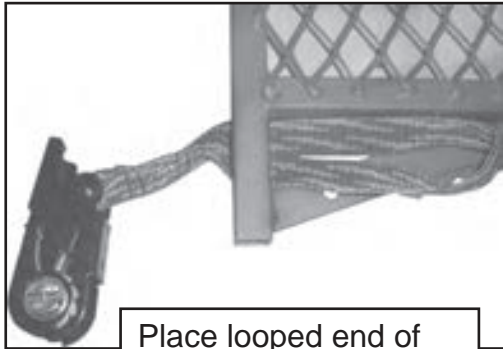

Place looped end of Ratchet under platform

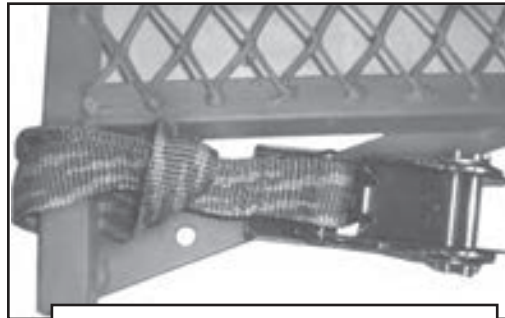

Insert ratchet through loop



Pull to tighten



Place looped end of strap under platform

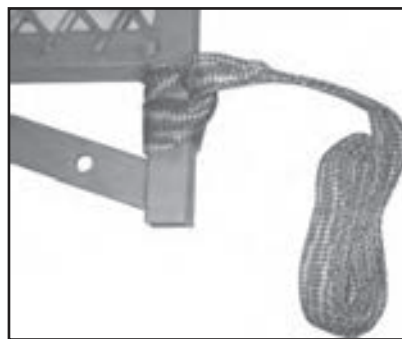

Insert strap through loop



Pull to tighten

Detailed Ratchet Strap Instructions



1

Open ratchet handle flat and insert end of strap through opening.



2

Pull Strap through opening

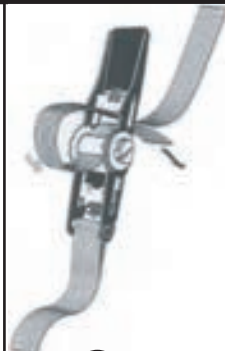

3

Insert end of strap through slot in ratchet wheel.



4

Ratchet handle back and forth to tighten strap



5

After strap is tight, close handle to the locked position



6

To release tension, push spring loaded retaining lock and simultaneously pull on strap.

INSTALLATION STRAP INSTRUCTIONS



1. Place looped end of strap under platform.

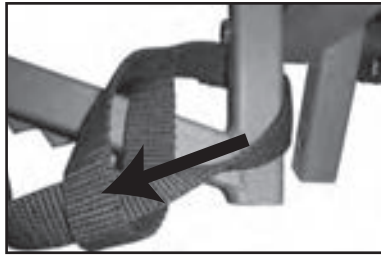

2. Insert loose end of strap through the loop.

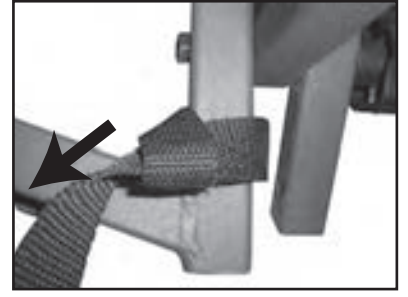

3. Pull to tighten. Continue with these steps to install the other strap on the other side of the platform.

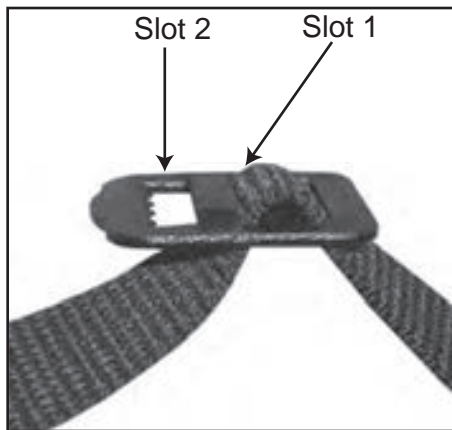

4. Place loose end of strap with clip, under the top rung of the bottom ladder section.

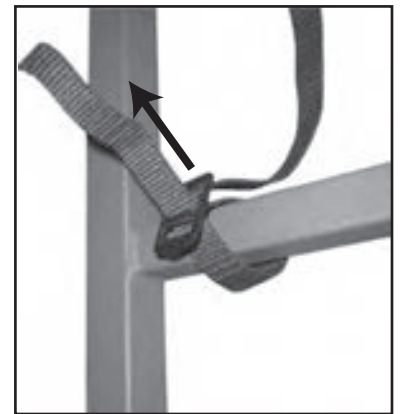

5. Insert the strap through Slot 1 on the clip.



6. Insert the strap through the Slot 2 with the teeth.

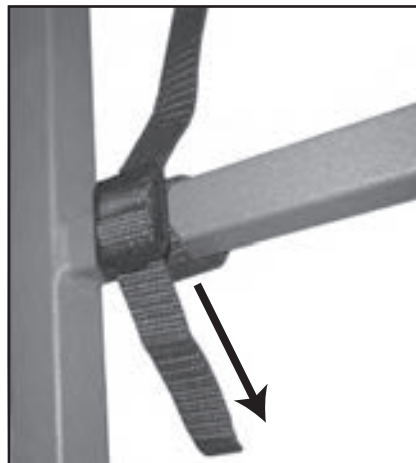

7. Pull strap to tighten.

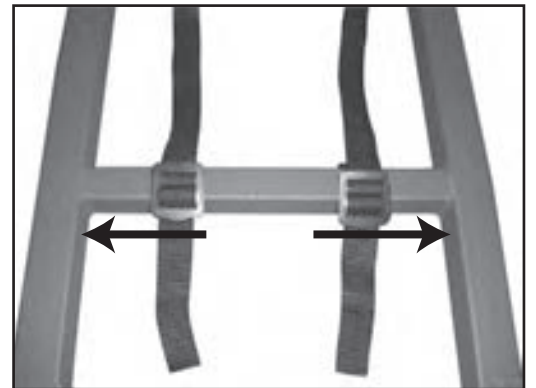

8. Slide the buckles out to the sides to create tension on the straps.

⚠ WARNING DO NOT sit on seat platform until the ratchet and installation straps have been secured.



WARNING

Failure to follow all warnings listed below could result in serious injury or death.

ALWAYS read and understand all warnings and instructions before each use of this product. Failure to read and understand all warnings and instructions may result in serious injury or death.

ALWAYS inspect the tree stand for signs of wear or damage **BEFORE** each use. Also inspect to ensure that nuts and bolts are secure and straps are not frayed, worn, or broken.

NEVER exceed weight limit of **300 lbs.** **DO NOT** use if your combined weight with all your hunting gear and any accessories exceeds **300 lbs.** Use of tree stand over the weight limit may result in serious injury or death.

ALWAYS wear a Fall Arrest System (FAS) after leaving the ground. If you are not wearing an FAS that meets TMA standards, ***DO NOT leave the ground.*** Failure to wear an FAS may result in serious injury or death.

DO NOT use this tree stand while under the influence of alcohol, medication, or illegal substances. Use of tree stand while under the influence of any of these substances may result in serious injury or death.

NEVER use this tree stand if you have a history of health problems such as (*but not limited to*) heart problems, back problems, impaired vision, equilibrium impairments are afraid of heights or have been advised by a doctor not to do any strenuous activity. If you are feeling ill, nauseous, or dizzy **DO NOT** use this tree stand or If you are not physically fit, well rested and alert. Physical ailments can reduce your ability to safely install, utilize and remove your tree stand.

NEVER use this tree stand during inclement weather such as (*but not limited to*) thunderstorms, snowstorms, hurricanes, icy conditions, or high winds that could create slippery or dangerous situations.

NEVER use this tree stand on a dead, leaning, loose barked tree or on a utility pole as the tree may fall, break, or uproot and may result in serious injury or death.

NEVER leave the ground without checking every ladder section connection to ensure they are firmly connected. If ladder sections are separating, with the help of at least two other people, remove the tree stand from the tree, tighten all connections and reinstall on the tree.

Installation Straps, Ratchet Straps, Quickclips, Tiedown Ropes and Stabilizer Bars MUST be installed and secured prior to climbing tree stand. Failure to comply may result in serious injury or death.

DO NOT modify or alter your tree stand.

NEVER remove or deface warning labels.

