

PRIMETIME LITE

ALUMINUM CLIMBER



FIELD & STREAM™
1871

MODEL: HEH00557

- Always Wear a Safety Harness with this Product
- Practice Using at Ground Level
- Weight Limit: 300 lbs.
- Tree Size: 9"-18" diameter

Instruction and Safety Manual



THANK YOU! for purchasing the Primetime Lite Aluminum Climber by Primal Vantage Company Inc.

⚠ Warning

Every year serious injury and even death occurs from hunting related falls. To ensure your safety, please **COMPLETELY** read and follow this safety manual and ALL warning labels **BEFORE** assembling, installing or utilizing this product.

DO NOT USE THIS PRODUCT BEFORE FULLY UNDERSTANDING ALL SAFETY WARNINGS AND INSTRUCTIONS. IF YOU HAVE QUESTIONS, ARE UNSURE ABOUT ANY INFORMATION OR NEED ADDITIONAL INFORMATION CONCERNING YOUR PRODUCT, CONTACT OUR CUSTOMER SERVICE DEPARTMENT AT 1-866-972-6168 OR VISIT WWW.TREESTANDCUSTOMERSERVICE.COM. KEEP AND MAINTAIN THIS SAFETY AND INSTRUCTION MANUAL IN A SAFE LOCATION FOR FUTURE REFERENCE.

TREESTAND SAFETY WARNINGS

Please read the following instruction manual and warnings labels completely before utilizing this product. Failure to understand and execute the instructions and warnings may result in serious injury or death. In the event of an accident, have a plan for rescue, including the use of devices that may be easily reached while suspended. **NEVER** hunt without a rescue plan.

ALWAYS read and understand all warnings and instructions and use all safety devices provided before each use of this product. Failure to read and understand all warnings and instructions may result in serious injury or death. Contact a Customer Service Representative with any questions you may have.

NEVER exceed weight limit of **300 lbs.** **DO NOT** use if your combined weight with all of your hunting gear and any accessories exceeds **300 lbs.** Use of tree stand over the weight limit may result in serious injury or death.

DO NOT use this tree stand while under the influence of alcohol, medication or any illegal substances. Use of tree stand while under the influence of any of these substances may result in serious injury or death.

NEVER use this treestand during inclement weather. **DO NOT** use tree stand during thunderstorms, snowstorms, hurricanes, tornadoes or any other weather conditions that include (but not limited to) lightning, icy conditions, or high winds that could create slippery or dangerous situations.

NEVER use treestand if you are feeling ill, nauseous, or dizzy. Physical ailments can reduce your ability to safely install, utilize, and remove your treestand. Please consult a physician prior to use.

NEVER use this tree stand if you have a history of health problems such as (but not limited to) heart problems, back problems, high blood pressure, impaired vision, equilibrium impairments, are afraid of heights, have been advised by a doctor or physician not to climb. If you are not physically fit, well rested, and alert, or if you have any other physical or mental condition that would impair your ability to properly use this treestand.

NEVER use this tree stand on a tree that is dead, leaning, diseased, loose barked or on a utility pole as the tree may fall, break, or uproot and may result in serious injury or death. **NEVER** rely on a tree branch for support. **NEVER** jump or bounce on a treestand to seat it to the tree.

NEVER rely on a branch for support.

NEVER jump or bounce on the treestand's platforms to seat it to the tree.

NEVER transport any of your equipment with yourself while ascending or descending the tree. You will need to have two hands free during ascending and descending for safety. Use a haul line to pull up your firearm (unloaded, chamber opened with safety lock engaged, barrel facing towards the ground), bows, arrows, knives or any other equipment to your tree stand once you have reached your desired hunting height. **ONLY** pull up hunting equipment after the tree stand has been secured to the tree and after you and your harness have been secured to the tree. Prior to descending, lower your equipment on the opposite side of the tree from which you are climbing. Make sure that the unloaded firearm's safety lock is engaged and the gun barrel is pointing towards the ground.

ALWAYS inform someone of your hunting location, where the treestand will be located and the expected duration of the hunt. **ALWAYS** hunt with a plan and a buddy. Before you leave home, let others know your exact location, when you plan to return and who is with you.

ALWAYS carry emergency signal devices such as a cell phone, walkie-talkie, whistle, signal flare, PLD (personal location device) and flashlight with you at all times and within reach even while you are suspended in your harness. Watch for changing weather conditions. In the event of an accident, remain calm and seek help immediately.

ALWAYS inspect the tree stand and the Fall Arrest System (Harness) for signs of wear or damage **BEFORE** each use. Also inspect to ensure that nuts and bolts are secure. Pay special attention to the harness and straps, guaranteeing that nothing has been frayed or severed. Destroy all products that cannot be repaired by the manufacturer. Contact a Customer Service Representative for replacement parts. The Fall Arrest System **MUST** be discarded and replaced after a fall has occurred. **DO NOT** store treestand or safety harness outdoors when not in use.

DO NOT modify or alter your tree stand. Improper installation or adjustment may cause serious injury or death. Remove all contents from box. Inspect for any damaged or missing parts. If any parts are missing or damaged, you must only use certified replacement parts. Using any other replacement parts will void product warranty. **THERE ARE NO EXTRA PARTS.** All parts **MUST** be used to ensure the safety of you and your stand. If you think parts are missing or damaged, **STOP IMMEDIATELY** and contact our Customer Service Department. Using the tree stand with missing or damaged parts may result in serious injury or death. Contact a Customer Service Representative if you have any missing, damaged or extra parts.

PRACTICE installing, adjusting and using your tree stand at ground level prior to using it at an elevated position. Familiarize yourself with the use of climbers by practicing at ground level before using in a hunting environment.

ALWAYS keep Instructions (written and video) in a safe place and review before each use. It is the responsibility of the treestand owner to furnish the complete instructions to anyone who borrows or purchases the treestand from you.

NEVER use this treestand for any use other than hunting. Our treestands are designed for hunter's to wear a Full Body Harness. If you are not completely comfortable and confident with your ability to safely install, ascend, hunt and descend using a Full Body Safety Harness and this treestand, **DO NOT PROCEED.**

NEVER use this treestand for trimming trees.

NEVER fall asleep in your stand as you may fall out resulting in serious injury or death.

ALWAYS be sure to retighten all bolts **BEFORE** each new use of treestand.

ALWAYS have a minimum of three people present when installing or removing this treestand.

NEVER adjust your stand while in use. **ALWAYS** ensure that you and your treestand are safely secured to a healthy tree. Your tree stand **MUST** be attached tightly to the tree and secured in place. If the stand is not secure, it may shift while in use, resulting in serious injury or death.

©2011 (rev 02/11)

TREESTAND SAFETY WARNINGS

DO NOT leave your treestand outside since weather and animals may cause damage. Tree growth can also cause stress and damage straps and buckles. It must be stored inside when not in use.

NEVER wear jewelry or loose fitting clothing, which can cause hazardous conditions. Clothing may be caught in your equipment and cause you to fall. You must always wear non-slip or rubber boots. Shoelaces must be tucked into your boots. Rings and necklaces **MUST NOT** be worn.

NEVER use this treestand with a second person. The treestand is designed for use by **ONE** person.

NEVER let children play with or use this treestand without adult supervision. This treestand is not a toy.

DO NOT use tree stand if any nuts or bolts or parts are loose, bent, or crooked.

ALWAYS know your physical limitations. Don't take chances. If you start thinking about how high you are, don't go any higher. Instead, choose a minimum height that will allow for safe, effective and comfortable hunting.

ALWAYS wear a Fall Arrest System (FAS) (Harness) consisting of a full body safety harness after leaving the ground. A TMA Certified Full Body Harness **MUST** always be connected to yourself and the tree during ascending, hunting and descending. You **MUST** stay connected at all times after leaving the ground while using climbing and hang-on treestands. Single safety belts and chest harnesses are no longer allowed and should **NEVER** be used. If you are not wearing a Full Body Harness properly attached to the tree, that is protecting you from a fall, **DO NOT leave the ground**. Failure to wear your Full Body Harness may result in serious injury or death.

Be aware that falls can occur at anytime after leaving the ground.

ALWAYS read and understand the manufacturer's Warnings, expiration date (if applicable) and instructions on how to use and how to properly adjust the harness. Practice the use of a full body safety harness at ground level in the presence of a responsible adult to experience the feeling of hanging suspended before using in a hunting environment. Failure to follow harness instructions may result in not being able to return to the stand and being suspended in a harness after a fall, or serious injury or possibly death. If the hunting location is unknown by anyone and communication efforts are unsuccessful, you **MUST** have a personal plan for rescue/escape because prolonged suspension in a harness may be fatal. It is important to exercise the legs by pushing against the tree or doing other forms of continuous leg exercises to avoid blood pooling while being suspended. Hunters with varying degrees of physical fitness may require different plans to recover/escape the effects of prolonged suspension. Have a personal plan and practice it in the presence of a responsible adult before leaving the ground. No one escape/rescue plan will work for every hunter on every tree in every circumstance. Only you can determine the best recovery/escape plan for your situation before leaving the ground.

ALWAYS have a suspension relief device on your person and readily accessible while using a harness. These devices allow the user to relieve the load on the lower extremities if suspended in a harness and help maintain circulation in the legs, mitigate suspension trauma (blood pooling) or allow descent to the ground. Several optional products/systems are available that offer self-recovery or self-extraction from a fall when suspended in a harness. Some systems automatically descend the user while others allow user control. One of these products/systems can be considered for use as an additional safety precaution against prolonged suspension and suspension trauma. Be sure to follow the manufacturers' instructions on the safe use of these products/systems.

Hunt from the ground when self-recovery escape is absent. There is time to make a correct decision on what action to take if a fall occurs while wearing a full body harness. It is important to remember "**DO NOT PANIC.**" Remain calm and implement your practiced rescue, relief and recovery plan.

NEVER allow the tether strap to get under your chin or around our neck. The length of the harness tether **MUST** be minimized at all times. It should be adjusted so that it is above the head with no slack (snug) in the sitting position and you should have the minimum amount of slack possible when climbing.

NEVER lean out from the treestand for any reason.

The initial angle of the climber at ground level, **MUST** allow for the decrease in tree diameter while ascending by tilting slightly upward.

While climbing, adjustments to the harness tether should be frequent and coordinated with tree stand movement to maintain the least amount of slack in the tether that will allow for climbing.

NEVER remove any safety warning stickers from this product.

Safety must be your first priority during the use of this product.

WARNING

ALWAYS read and understand all warnings and instructions before each use of this product. Failure to read and understand all warnings and instructions may result in serious injury or death.

ALWAYS inspect the tree stand for signs of wear or damage **BEFORE** each use. Also inspect to ensure that nuts and bolts are secure and straps are not frayed, worn, or broken.

NEVER exceed weight limit of **300 lbs.** **DO NOT** use if your combined weight with all your hunting gear and any accessories exceeds **300 lbs.** Use of tree stand above the weight limit may result in serious injury or death.

ALWAYS wear a Fall Arrest System (FAS) (Harness) after leaving the ground. If you are not wearing an FAS, **DO NOT leave the ground.** Failure to wear an FAS may result in serious injury or death.

DO NOT use this treestand while under the influence of alcohol, medication, or other substances. Use of these substances may result in serious injury or death.

Manufactured in the year XXXX

NEVER use this tree stand if you have a history of health problems such as (*but not limited to*) heart problems, back problems, impaired vision, equilibrium impairments are afraid of heights or have been advised by a doctor not to do any strenuous activity. If you are feeling ill, nauseous, or dizzy **DO NOT** use this tree stand or if you are not physically fit, well rested and your ailments can reduce your ability to safely use your tree stand.

NEVER use this tree stand in inclement weather (but not limited to) rain, snow, storms, high winds, ice, or hazardous conditions. Wind gusts may create slippery or dangerous situations.

NEVER use this treestand on a leaning, rotten, or decayed tree or on a utility pole. A tree may lean, crack, or uproot and may result in serious injury or death.

ALWAYS make platform level adjustments at ground level.

ALWAYS ensure that the platforms are tilted slightly upward at ground level to allow for the decrease in tree diameter when ascending.

ALWAYS make sure that the top and bottom platforms are secured to the tree at the proper length recommended.

ALWAYS make frequent adjustments to the harness tether, coordinated with tree stand movement to maintain the least amount of slack in the tether that will allow for climbing.

ALWAYS practice at ground level before climbing in a hunting environment.

NEVER alter your tree stand.

NEVER remove or deface warning labels.

SAMPLE

2011 ©2011 (rev 02/11)

CHOOSING A SAFE TREE

- **ALWAYS** thoroughly inspect the tree before installing your product. **DO NOT** install your TREE/LADDER STAND onto any dead or unsafe tree, telephone or utility pole, structural column, or man-made structure. Doing so may result in serious injury or death.
- **ALWAYS** select the proper tree for use with your TREE/LADDER STAND. Select a live straight tree that fits within size limits recommended (minimum tree diameter must be no less than 9 inches and maximum of 18 inches.). **DO NOT** rely on a branch for support.
- **DO NOT** select a tree in the dark or choose a tree in close proximity to a fence. You must not have any stumps or rocks beneath your tree.
- **NEVER** use TREE/LADDER STAND on a tree that is dead, diseased, leaning or on wet and uneven ground as the tree may fall, break or uproot.
- Your tree must not be wet, icy or slippery or on wet, swampy, or loose ground that allows the tree to be unstable. Check the ground under TREE/LADDER STAND to ensure it is firm and level.
- Be sure you have a level stand platform. Your tree must not lean or have any irregular shape.
- Tree must not have any loose or scaly bark or excessive vines, nails, screws, or any other sharp objects protruding that may sever webbing on product. Any surrounding trees must not lean or have dead limbs that may fall onto you or your product.
- **NEVER HURRY!!** While climbing a TREE/LADDER STAND, make slow, even movements no more than ten to twelve inches at a time. Make sure you have proper contact with tree and/or TREE/LADDER STAND every time you move. **On ladder tree stand, ALWAYS maintain three points of contact with each step and ALWAYS lean forward as you climb.**

PROPER CARE AND MAINTENANCE:

- Inspect for defects (damage, rot, corrosion, cracks, freezing, excessive heat, etc.) before every use is required. Do not use if damage is detected or suspected.
- Ameristep recommends periodically re-tightening and/or replacing hardware (supplied by Ameristep), including bolts, nuts, washers, rope, straps, cord, etc.

PRIMETIME LITE ALUMINUM CLIMBER

MODEL: HEH00557

- Always Wear a Safety Harness with this Product
- Practice Using at Ground Level
- Weight Limit: 300 lbs.
- Tree Size: 9"-18" diameter



FIELD & STREAM™

1871

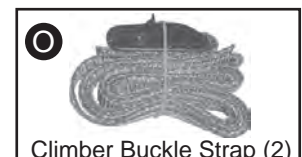
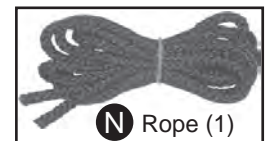
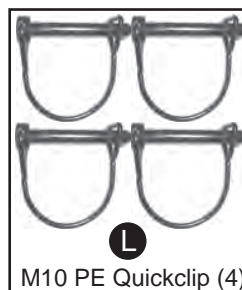
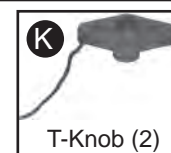
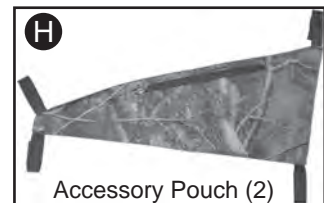
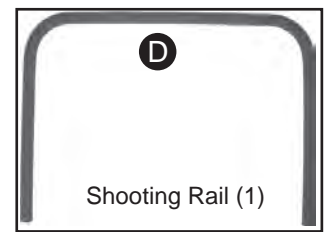
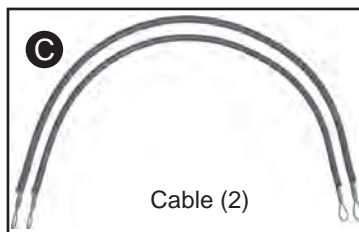
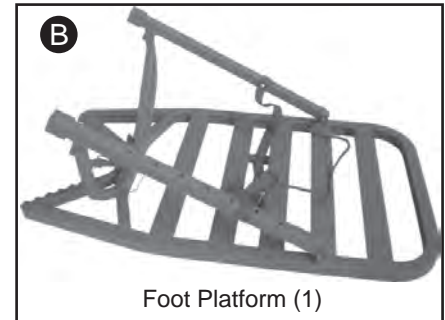
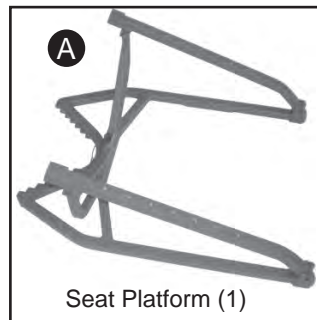
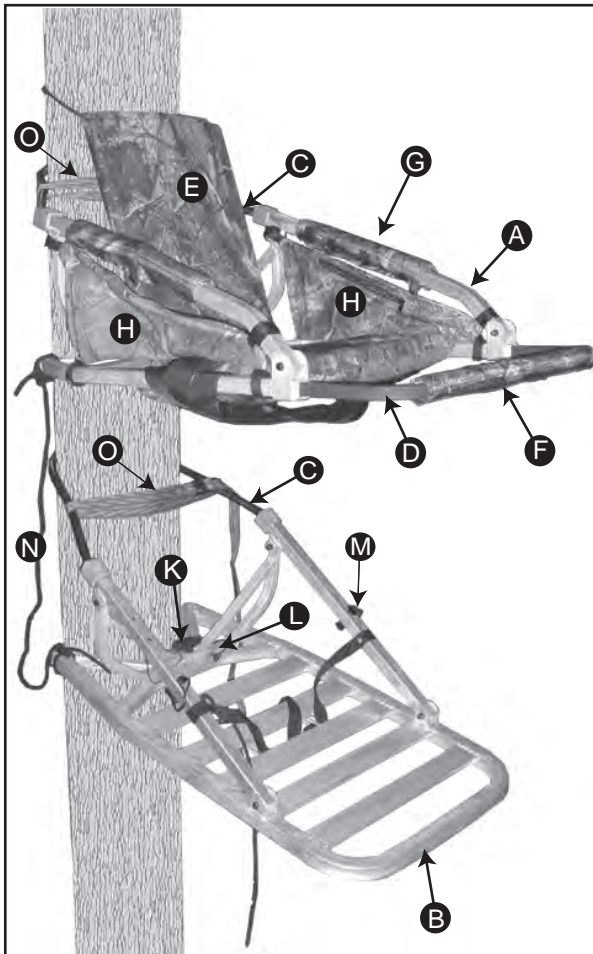

Parts List

A	1 Seat Platform	Part # DSP-513
B	1 Foot Platform	Part # DFP-513
C	2 Cable	Part # DC-100
D	1 Shooting Rail	Part # DSR-513
E	1 Seat Cushion	Part # DSC-513
F	1 Shooting Rail Cover	Part # DPSC-830
G	2 Arm Rest Cover	Part # DPAC-830
H	2 Accessory Pouch	Part # DAP-830
J	2 Backpack Strap	Part # DBS-830
K	2 T-Knob	Part # DK-500
L	4 M10 PE Quickclip	Part # DQ-615
M	4 M12 PE Quickclip	Part # DQ-815
N	1 Rope	Part # DR-100
O	2 Climber Buckle	Part # CB-100
	1 Harness	Part # 3001
75	2 M12x75mm Bolt	Part # 1875

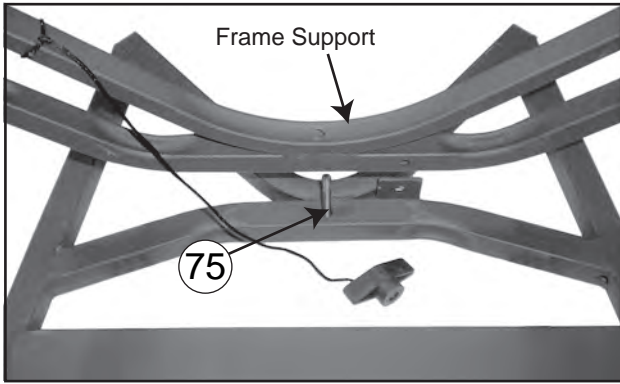

1. Insert **1-M12x75mm bolt** through the bottom of Seat Platform and **1-M12x75mm bolt** through the bottom of Foot Platform.

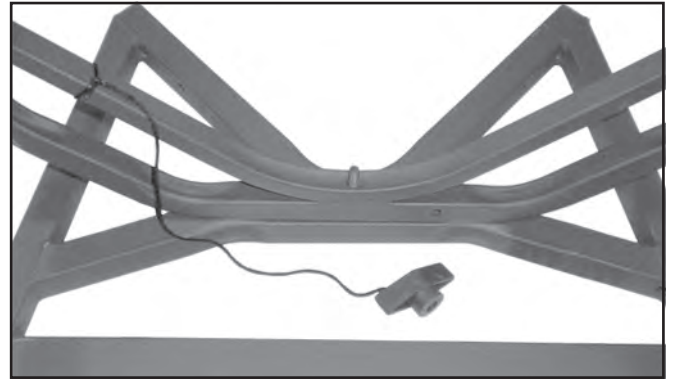

2. Lift railing and insert frame support through attached bolt

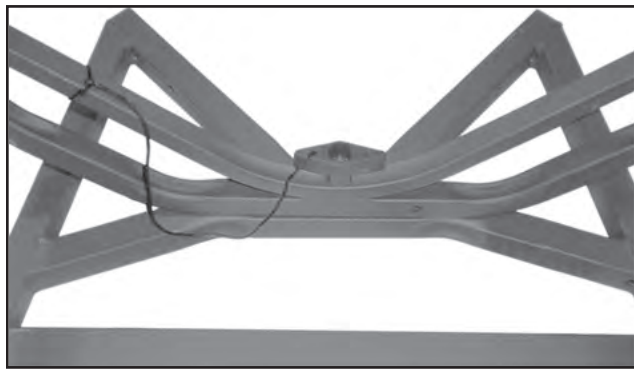

3. Thread T-knob on bolt.

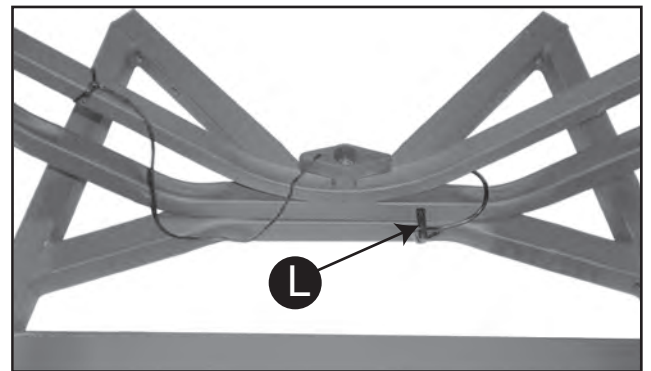

4. Insert **1-M10 Quickclip L** through frame support and welded tab to secure frame in place.

5. Repeat above steps to assemble the foot platform

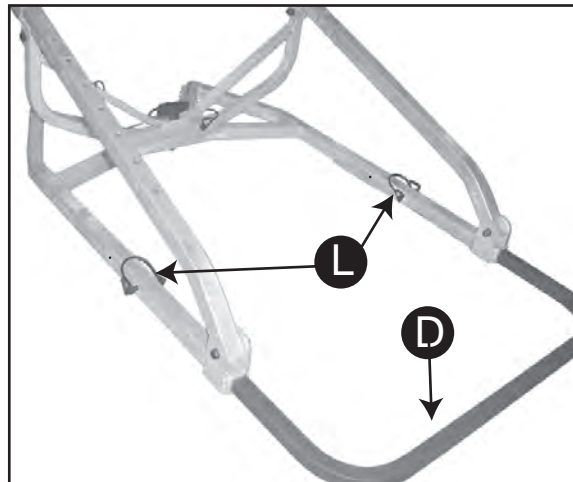

6. Insert Shooting Rail **D** into Seat Platform **A**. Adjust Shooting Rail to proper length and insert **2-M10 Quickclips L** through shooting rail and frame.

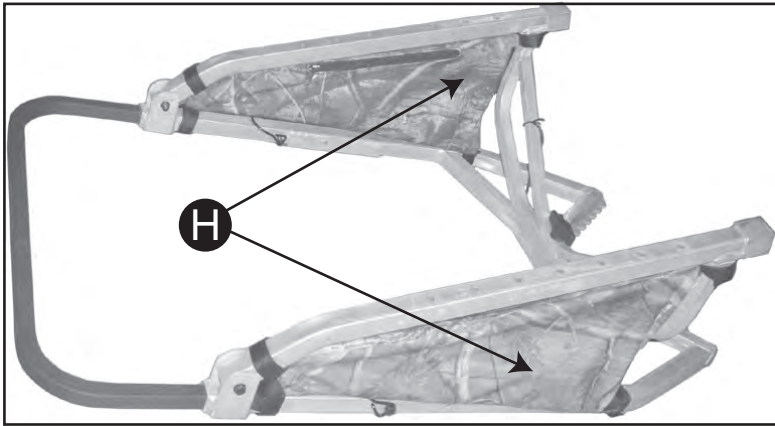

7. Attach Accessory Pouch **H** to the frame of the seat platform as shown.

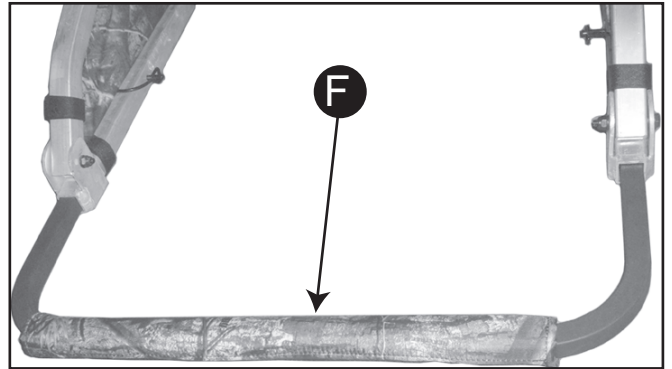

8. Attach Shooting Rail Cover **F** to the Shooting Rail.



9. Attach Seat Cushion **E** to the frame of Seat Platform **A**.
(See Seat Cushion Instructions.)



10. Attach Backpack Straps **J** to the underside of Foot Platform **B**.
(See Backpack Strap Instructions)

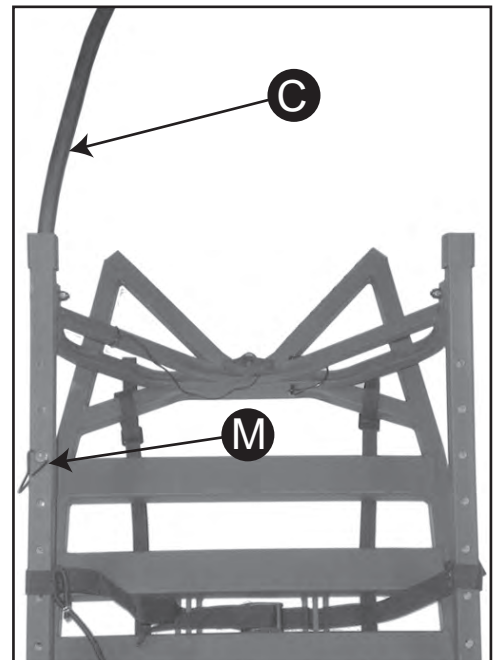

11. Insert one end of Cable **C** into Foot Platform Rail. Insert 1 - *M12 Quickclip* **M** into the rail and through the eyelet on the cable.

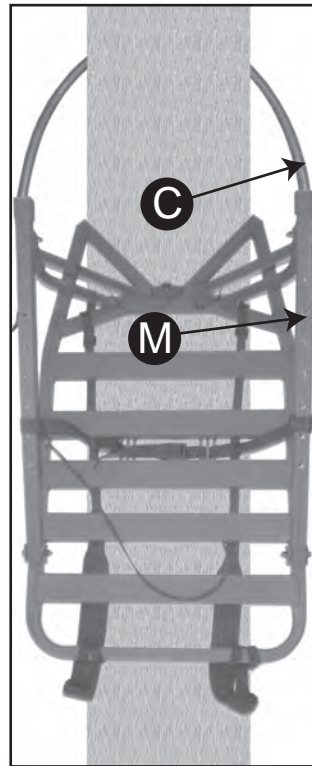
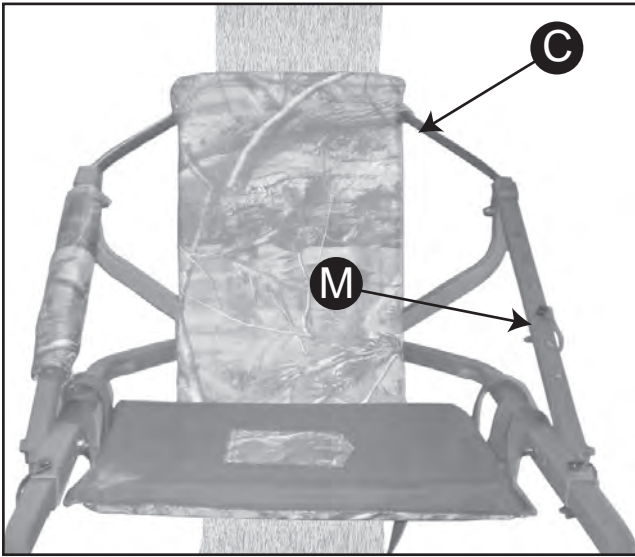

12. Wrap the cable around the back of the tree and insert the other end of Cable **C** into the opposite railing of the Foot Platform. Secure with **1-M12 Quickclip M**. Install the Seat Platform above Foot Platform in same fashion and at identical angle.

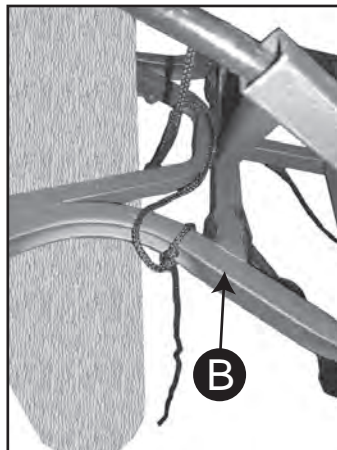
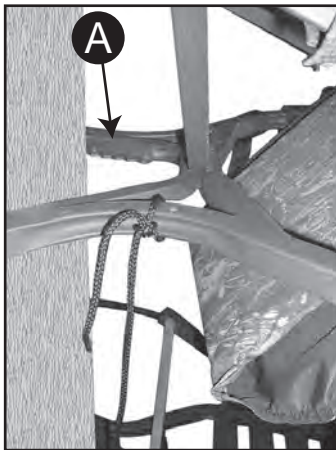

Have both top and bottom platforms angled down towards base of tree to compensate for a smaller tree diameter at desired hunting height.

13. Tie Rope **N** to Seat Platform **A** at the rear support and the other end to Foot Platform **B** at the rear support. **DO NOT** tie around the teeth.

At ground level, apply pressure to both platforms to ensure they have appropriate angle on tree and T-knobs are properly installed.



14. At ground level, step cautiously onto the foot platform. Attach your harness to the tree (as per harness manufacturer's instructions). Standing on the foot platform facing the tree, insert your feet into foot straps. Tighten foot straps as needed. Secure bungee strap around you heels to assist in keeping feet in foot straps. Raise Seat Platform to about chest height. The rope is used to secure both platforms together so the platforms will not fall away accidentally while climbing.

NOTE:
Images used are for demonstration purposes only and may not depict the actual product.

2011 (rev 12/10)

Backpack Strap Instructions

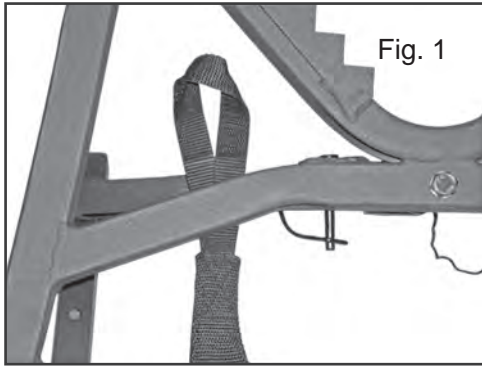

Fig. 1

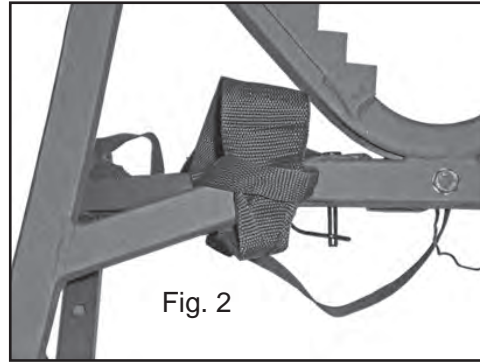

Fig. 2

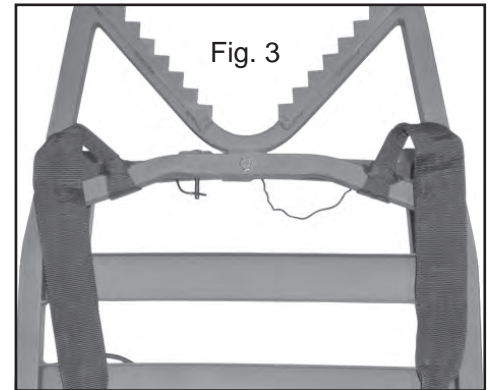

Fig. 3

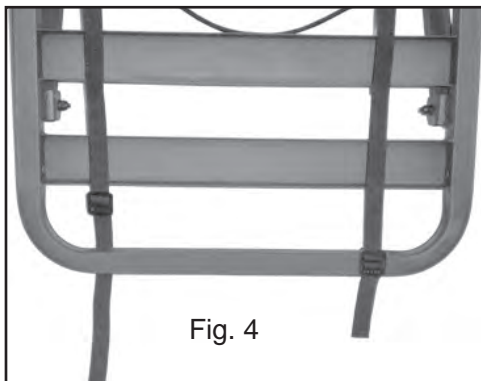

Fig. 4

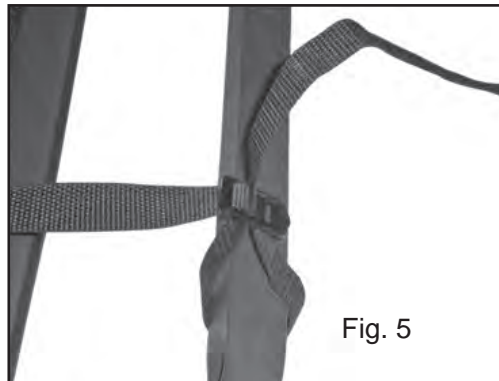

Fig. 5

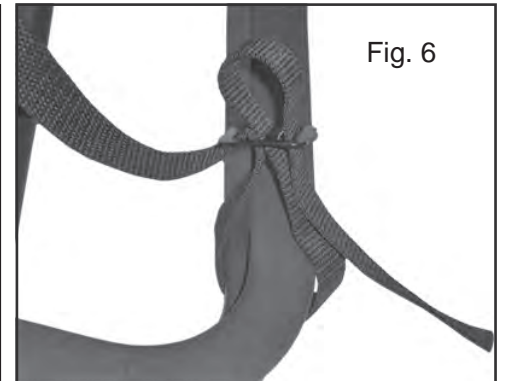

Fig. 6

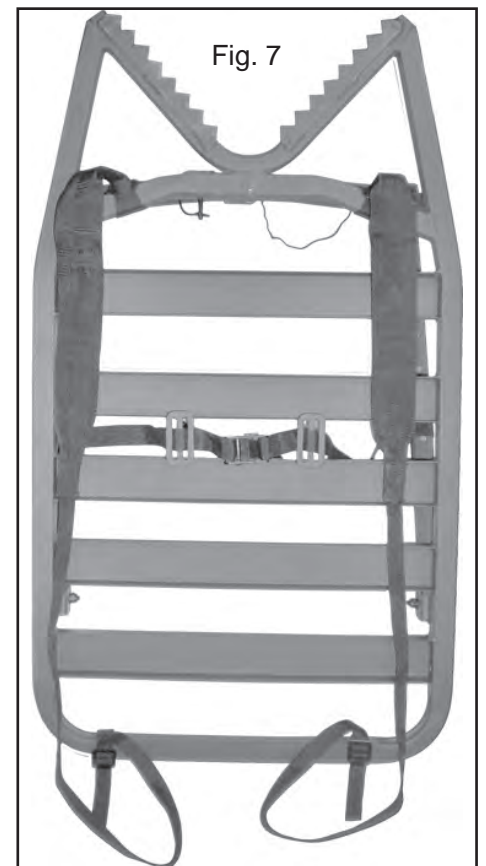

Fig. 7

1. Turn Foot Platform over, insert the looped ends of the backpack straps up through the rear frame of the platform . **(See Fig. 1)**
2. Insert the other end of the strap back through the loop and pull tight. **(See Fig. 2)**
3. Insert the loose end of the strap through the front of the platform. **(See Fig. 4)**
4. Insert the strap end through the slot with the teeth on the clip. **(See Fig. 5)**
5. Insert the strap end back through the second slot on the clip. Pull to tighten. **(See Fig. 6)**
6. Follow steps 1- 5 for the other Backpack Strap and your straps should look like **Fig. 7.**

CLIMBING INSTRUCTIONS

CAUTIOUSLY put your weight on the foot platform.
The additional weight will create tension on tree strap cables.

Before beginning to climb: Check that your harness is secure, check that cables are properly quickclipped, and make sure that the seat straps on your seat section are off to the side, they should not obstruct the cable connecting to the tree in anyway while climbing.

Practice at ground level with you Full Body Harness.

Familiarize yourself with this product's function so you feel comfortable with the climbing procedure.

1. Sit on shooting rest and lift your feet to raise foot platform. Push down to set foot platform in raised position. **FIG.1**
2. Stand and lift up on seat platform to adjust it to a comfortable level. Push down to set seat platform in raised position. Raise your harness tether to take up the slack. **FIG. 2**
3. Again, sit on shooting rest and lift you feet to raise foot platform. Push down to set foot platform in raised position. **FIG.1**
4. To continue climbing up tree, repeat steps 1 through 3. Continuously adjust your harness to keep strap above your head with minimum slack.
5. When you have reached the desired height to hunt from, wrap each Climber Buckle  around each cable in the front of the tree. **FIG.3** Thread the strap through the buckle and pull tight. (**See Buckle Instructions**). The straps should be in front of the tree and **NOT** wrapped around the tree. Pull excess slack through buckle, this will lock the platforms into place on the tree.
6. Carefully remove one foot at a time from the foot straps. Slowly turn around never taking both feet off of the foot platform, you **MUST** always have weight pressed on the foot platform.
7. Sit on the seat cushion, if any adjustment needs to be made to the seat placement, you **MUST** climb back to the ground and adjust on the ground. Using a safe hoist/lift system, raise your unloaded weapon.
8. To climb back down the tree, reverse the process, always ensuring you are constantly adjusting your harness tether as you move.

Have both top and bottom platforms angled down towards base of tree to compensate for a smaller tree diameter at desired hunting height.

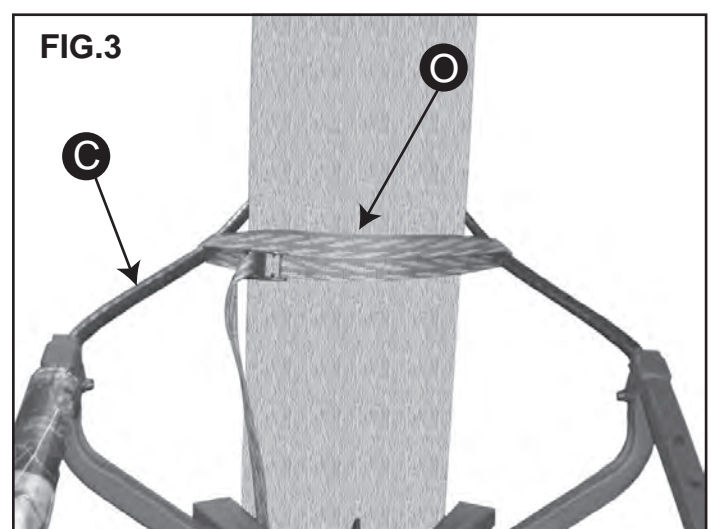

NOTE:
Images used are for demonstration purposes only and may not depict the actual product.

Backpacking Instructions Page 1

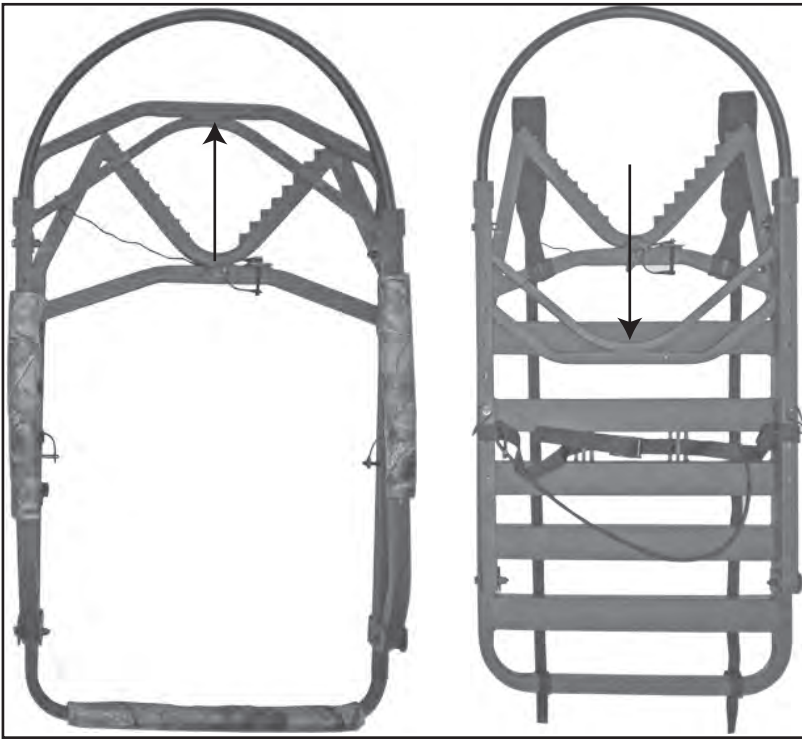

1. Remove Seat Cushion from Seat Platform. Fold platform so rail is towards the cable towards the rear of the platform. Screw the T-Knob back on the bolt. Insert the quickclip through the tab on the frame.

2. Fold Foot Platform so that the rail is facing away from the cable towards the front of the platform. Screw the T-Knob back on the bolt. Insert the quickclip through the tab on the frame.

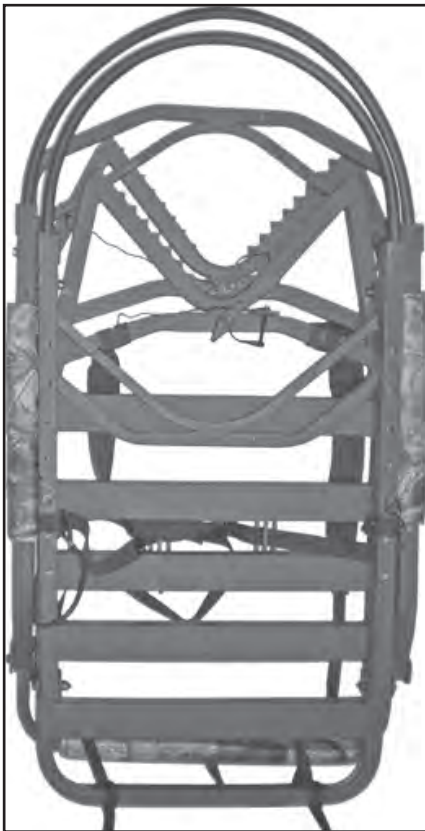

3. Place Foot Platform on top and between the armrests of the Seat Platform. The folded part of the support bar should be against the T-Knob of the Seat Platform.

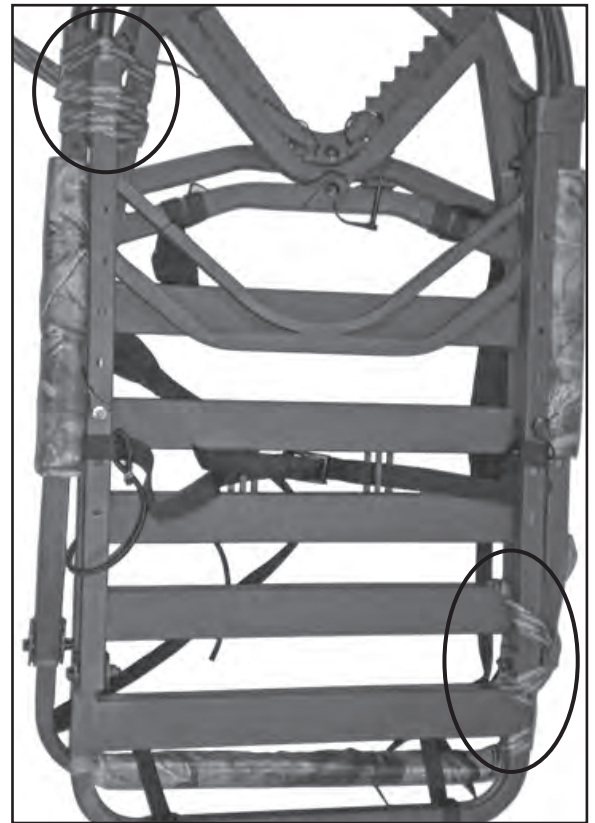

4. Wrap the Climber Buckles around the Seat and Foot Platforms at each corner. This will hold the platforms together.



5. Flip over the platforms so the bottom of the foot platform is on top. Pull the backpack straps out to the sides.



6. Place the Seat Cushion on top of the Foot Platform. Put the straps of the Seat Cushion underneath the backpack straps.

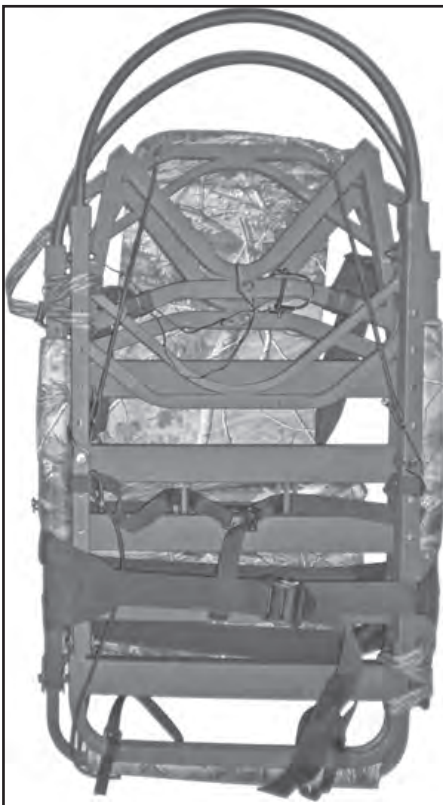

7. Flip Platforms back over so that the Seat Cushion is on the bottom. Thread the Seat Cushion strap together.

Take the bungee strap from the top of the Seat Cushion and hook it to the quickclips that are holding in the cables.

8. Insert each arm through the backpack straps with the seat cushion against your back.



Seat Cushion Instructions

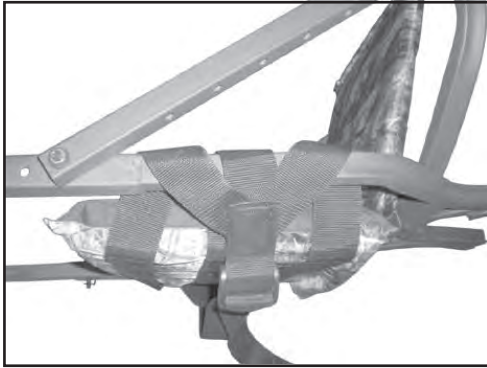

1. Place Seat Cushion between the armrests with the straps facing the ground. Insert the buckle end of the strap through the armrests and around the handle rail.

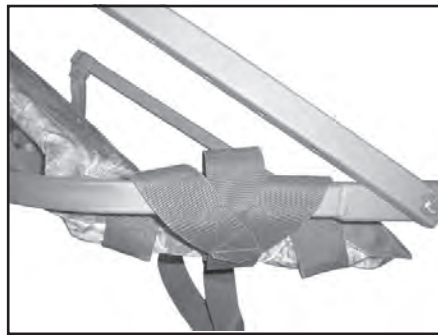

2. Insert the loose end of the strap through the opposite armrest and around the handle rail.

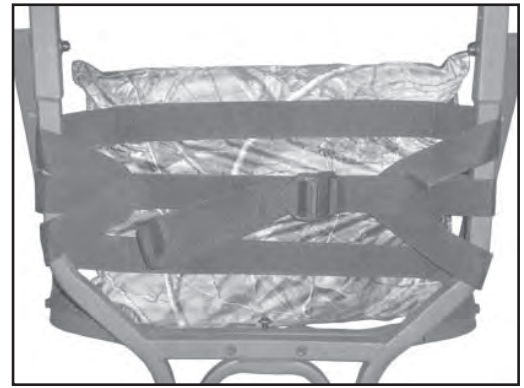

3. Pull strap underneath seat cushion and thread through the buckle.

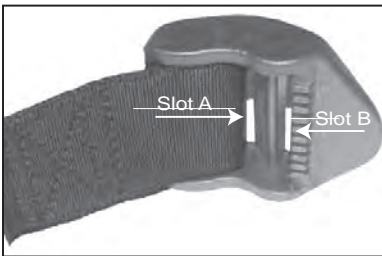

4. Hold Buckle as shown. You should be able to see two slots A&B.



5. Insert loose strap through Slot A.

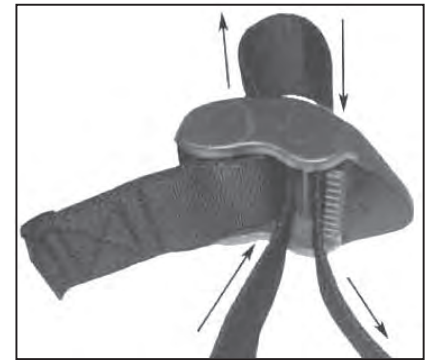

6. Continue pulling strap through Slot A. Insert strap through Slot B.

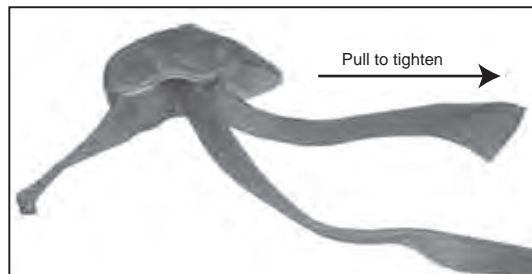

7. Continue to pull strap until tight.

Detailed Buckle and Strap Instructions

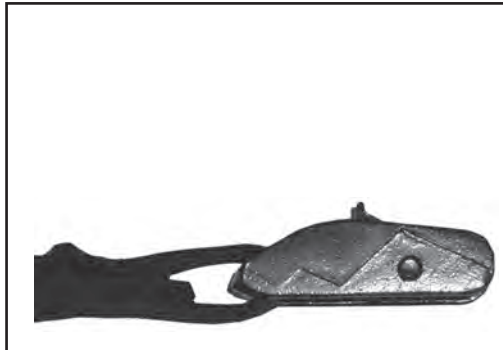

1

Hold buckle as shown

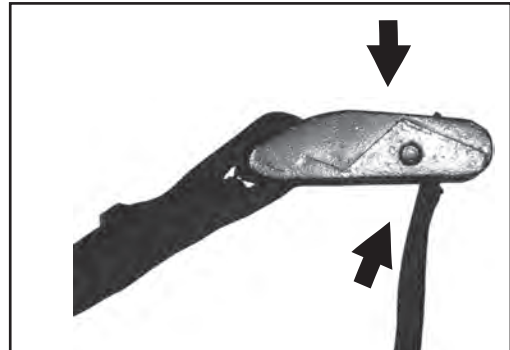

2

Press down on latch and insert strap underneath teeth as shown.



3

Pull strap to desired length.

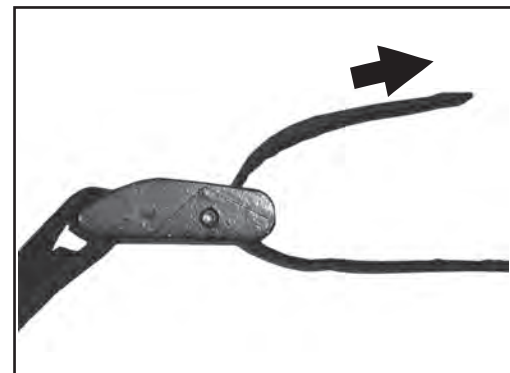

4

Pull slack to tighten.

ALWAYS tug on strap to make sure it is secured by the buckle before use



WARNING

Failure to follow all warnings listed below could result in serious injury or death.

ALWAYS read and understand all warnings and instructions before each use of this product. Failure to read and understand all warnings and instructions may result in serious injury or death.

ALWAYS inspect the tree stand for signs of wear or damage **BEFORE** each use. Also inspect to ensure that nuts and bolts are secure and straps are not frayed, worn, or broken.

NEVER exceed weight limit of **300 lbs.** **DO NOT** use if your combined weight with all your hunting gear and any accessories exceeds **300 lbs.** Use of tree stand over the weight limit may result in serious injury or death.

ALWAYS wear a Fall Arrest System (FAS) after leaving the ground. If you are not wearing an FAS that meets TMA standards, **DO NOT leave the ground.** Failure to wear an FAS may result in serious injury or death.

DO NOT use this tree stand while under the influence of alcohol, medication, or illegal substances. Use of tree stand while under the influence of any of these substances may result in serious injury or death.

NEVER use this tree stand if you have a history of health problems such as (*but not limited to*) heart problems, back problems, impaired vision, equilibrium impairments are afraid of heights or have been advised by a doctor not to do any strenuous activity. If you are feeling ill, nauseous, or dizzy **DO NOT** use this tree stand or If you are not physically fit, well rested and alert. Physical ailments can reduce your ability to safely install, utilize and remove your tree stand.

NEVER use this tree stand during inclement weather such as (*but not limited to*) thunderstorms, snowstorms, hurricanes, icy conditions, or high winds that could create slippery or dangerous situations.

NEVER use this tree stand on a dead, leaning, loose barked tree or on a utility pole as the tree may fall, break, or uproot and may result in serious injury or death.

ALWAYS make platform level adjustments at ground level.

ALWAYS ensure that the platforms are tilted slightly upward at ground level to allow for the decrease in tree diameter when ascending.

ALWAYS make sure that the straps connecting the top and bottom platforms are secured and at the proper length recommended.

ALWAYS make frequent adjustments to the harness tether, coordinated with tree stand movement to maintain the least amount of slack in the tether that will allow for climbing.

ALWAYS practice at ground level before using in a hunting environment.

DO NOT modify or alter your tree stand.

NEVER remove or deface warning labels.