

19' WRAPAROUND LADDERSTAND

MODEL: 51039/9427A

- Always Wear a Safety Harness with this Product
- Practice Using at Ground Level
- Weight Limit: 500 lbs.
- Tree Size: 9"-18" diameter

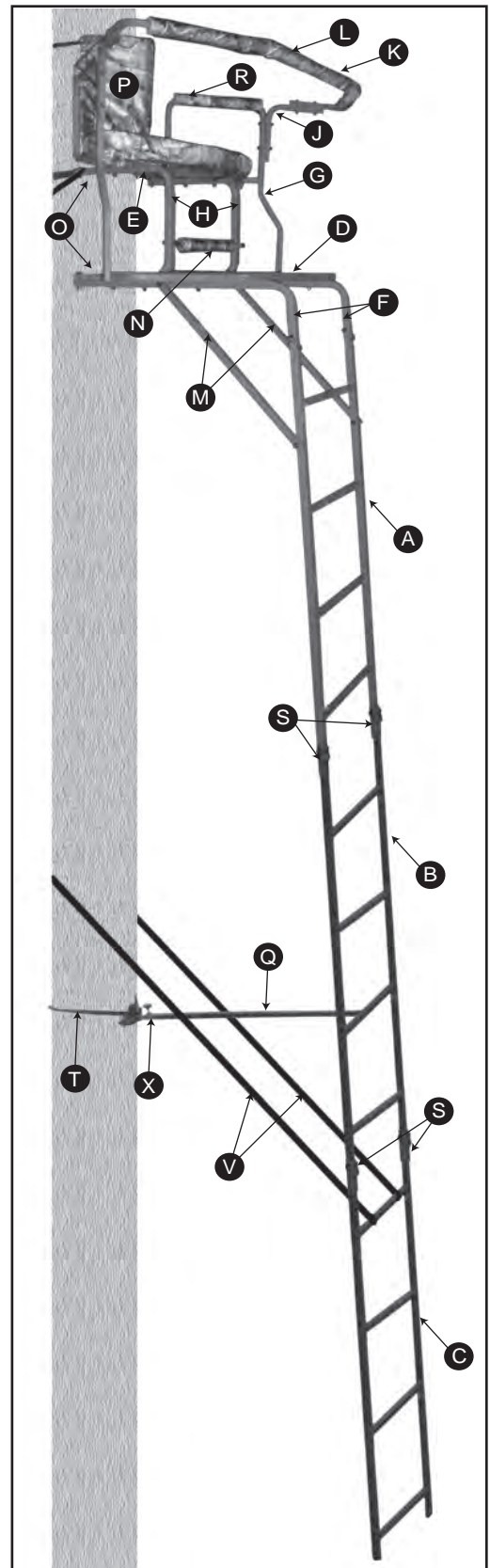
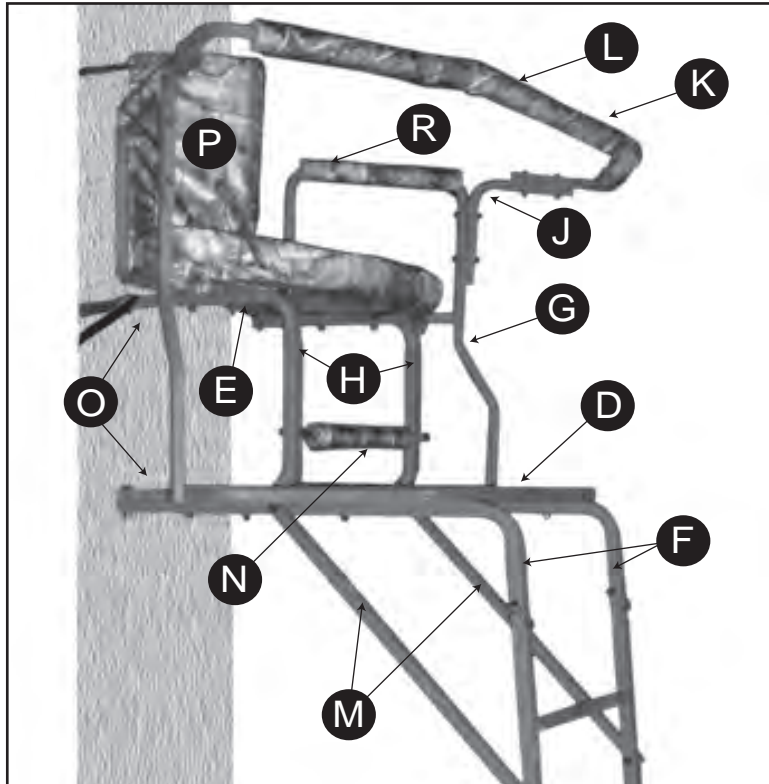

THANK YOU! for purchasing the 19' Wraparound Ladderstand by Ameristep Inc.

A Warning

Every year serious injury and even death occurs from hunting related falls. To ensure your safety, please **COMPLETELY** read and follow this safety manual and ALL warning labels **BEFORE** assembling, installing or utilizing this product.

DO NOT USE THIS PRODUCT BEFORE FULLY UNDERSTANDING ALL SAFETY WARNINGS AND INSTRUCTIONS. IF YOU HAVE QUESTIONS, ARE UNSURE ABOUT ANY INFORMATION OR NEED ADDITIONAL INFORMATION CONCERNING YOUR PRODUCT, CONTACT OUR CUSTOMER SERVICE DEPARTMENT AT 1-8866-972-6168 OR VISIT WWW.TREESTANDCUSTOMERSERVICE.COM. KEEP AND MAINTAIN THIS SAFETY AND INSTRUCTION MANUAL IN A SAFE LOCATION FOR FUTURE REFERENCE.

TREESTAND SAFETY WARNINGS

Please read the following instruction manual and warnings labels completely before utilizing this tree stand. Failure to understand and execute the instructions and warnings may result in serious injury or death. In the event of an accident, have a plan for rescue, including the use of devices that may be easily reached while suspended. **NEVER** hunt without a rescue plan.

ALWAYS read all warnings and instructions before each use of this tree stand. Failure to read all warnings and instructions may result in serious injury or death.

ALWAYS inspect the tree stand and the Fall Arrest System (Harness) for signs of wear or damage **BEFORE** each use. Also inspect to ensure that nuts and bolts are secure. Pay special attention to the harness and straps, guaranteeing that nothing has been frayed or severed. Destroy all products that cannot be repaired by the manufacturer. Contact a Customer Service Representative for replacement parts. The Fall Arrest System **MUST** be discarded and replaced after a fall has occurred.

NEVER exceed total weight limit of **500 lbs.** **DO NOT** use if the total combined weight of one person with all of your hunting gear and any accessories exceeds **300 lbs.** or the combined weight of two people and equipment exceeds **500 lbs.** **DO NOT exceed the weight limit of the safety harness, refer to harness manufacturer's warnings for weight limit of safety harness.** Use of tree stand over the weight limit may result in serious injury or death.

NEVER let children play with or use this tree stand without adult supervision. This tree stand is not a toy.

DO NOT use this tree stand while under the influence of alcohol, medication or any illegal substances. Use of tree stand while under the influence of any of these substances may result in serious injury or death.

NEVER use this tree stand during inclement weather. **DO NOT** use tree stand during thunderstorms, snowstorms, hurricanes, tornadoes or any other weather conditions that include (but not limited to) lightning, icy conditions, or high winds that could create slippery or dangerous situations. End your hunt and return to the ground if inclement weather conditions arise.

NEVER use this tree stand if you have a history of health problems such as (but not limited to) heart problems, back problems, high blood pressure, impaired vision, equilibrium impairments, are afraid of heights, have been advised by a doctor or physician not to climb. If you are not physically fit, well rested, and alert, or if you have any other physical or mental condition that would impair your ability to properly use this tree stand.

NEVER use tree stand if you are feeling ill, nauseous, dizzy or if you have prior medical conditions that could cause a problem i.e., heart condition, joints that lock-up, spinal fusions, etc. or if you are not well rested and alert. Physical ailments can reduce your ability to safely install, utilize, and remove your tree stand. Please consult a physician prior to use.

NEVER wear jewelry or loose fitting clothing, which can cause hazardous conditions. Clothing may be caught in your equipment and cause you to fall. You must always wear non-slip or rubber boots. Shoelaces must be tucked into your boots. Rings and necklaces **MUST NOT** be worn.

NEVER use this tree stand on a tree that is dead, leaning, diseased, loose barked or on a utility pole as the tree may fall, break, or uproot and may result in serious injury or death.

NEVER transport any of your equipment with yourself while ascending or descending the tree. You will need to have two hands free during ascending and descending for safety. Use a haul line to pull up your firearm (unloaded, chamber opened with safety lock engaged, barrel facing towards the ground), bows, arrows, knives or any other equipment to your tree stand once you have reached your desired hunting height. **ONLY** pull up hunting equipment after the tree stand has been secured to the tree and after you and your harness have been secured to the tree. Prior to descending, lower your equipment on the opposite side of the tree from which you are climbing. Make sure that the unloaded firearm's safety lock is engaged and the gun barrel is pointing towards the ground.

ALWAYS hunt with a plan and a buddy. Before you leave home, let others know your exact location, when you plan to return and who is with you.

ALWAYS carry emergency signal devices such as a cell phone, walkie-talkie, whistle, signal flare, PLD (personal location device) and flashlight with you at all times and within reach even while you are suspended in your harness. Watch for changing weather conditions. In the event of an accident, remain calm and seek help immediately.

NEVER modify or alter your tree stand in anyway by making repairs, replacing parts, or altering, adding or attaching anything to it except if explicitly authorized by the manufacturer. Improper installation or adjustment may cause serious injury or death. Remove all contents from box. Inspect for any damaged or missing parts. If any parts are missing or damaged, you must only use certified replacement parts. Using any other replacement parts will void product warranty. **THERE ARE NO EXTRA PARTS.** All parts **MUST** be used to ensure the safety of you and your stand. If you think parts are missing or damaged, **STOP IMMEDIATELY** and contact our Customer Service Department. **DO NOT** use tree stand if any nuts or bolts or parts are loose, bent, or crooked. Using the tree stand with missing or damaged parts may result in serious injury or death. Contact a Customer Service Representative if you have any missing, damaged or extra parts.

PRACTICE installing, adjusting and using your tree stand at ground level prior to using it at an elevated position.

ALWAYS step firmly on the first rung of the bottom ladder section to set the ladder into the ground before proceeding to climb the ladder.

NEVER use homemade or permanently elevated stands or make modifications to a purchased tree stand.

ALWAYS have a minimum of three people present when installing or removing this tree stand.

ALWAYS know your physical limitations. Don't take chances. If you start thinking about how high you are, don't go any higher. Instead, choose a minimum height that will allow for safe, effective and comfortable hunting.

TREESTAND SAFETY WARNINGS

NEVER adjust your stand while in use. Practice the attachment of this treestand at ground level before using in a hunting environment. **ALWAYS** ensure that you and your treestand are safely secured to a healthy tree. Your tree stand **MUST** be attached tightly to the tree and secured in place. If the stand is not secure, it may shift while in use, resulting in serious injury or death.

The Installation Cross Straps and Stabilizer Bar(s) **MUST** be properly installed before each use of the treestand.

ALWAYS inspect every ladder section connection every time you use the stand before you leave the ground. If ladder sections are separating, with the help of at least two other people, lower the stand to the ground, make adjustments, and reinstall.

ALWAYS check the ground below the tree stand to make sure it is firm and level. Sloping ground or uneven terrain (one side of a rock or root) can cause your tree stand to tilt or shift.

ALWAYS maintain three points of contact when climbing the tree stand. (Two feet and one hand **or** one foot and two hands.)

DO NOT leave your treestand outside since weather or animals may cause damage. Tree growth can also cause stress and damage straps and buckles. It must be stored inside when not in use.

NEVER wear jewelry or loose fitting clothing, which can cause hazardous conditions. Clothing may be caught in your equipment and cause you to fall. You must always wear non-slip or rubber boots. Shoelaces must be tucked into your boots. Rings and necklaces **MUST NOT** be worn.

NEVER use this treestand with a third person. The treestand is designed for use by **ONE** person or **TWO** people.

NEVER let children play with or use this treestand without adult supervision. This treestand is not a toy.

DO NOT use tree stand if any nuts or bolts or parts are loose, bent, or crooked.

ALWAYS know your physical limitations. Don't take chances. If you start thinking about how high you are, don't go any higher. Instead, choose a minimum height that will allow for safe, effective and comfortable hunting.

ALWAYS lean **forward towards the tree** as you climb and attach your harness to the tree **BEFORE** securing the platform to the tree and stepping onto the platform. **NEVER** lean out from the treestand for any reason.

ALWAYS wear a Fall Arrest System (FAS) (Harness) consisting of a full body safety harness after leaving the ground. A TMA Certified Full Body Harness **MUST** always be connected to yourself and the tree during ascending, hunting and descending. Single safety belts and chest harnesses are no longer allowed and should **NEVER** be used. If you are not wearing a Full Body Harness properly attached to the tree, that is protecting you from a fall, **DO NOT leave the ground**. Failure to wear your Full Body Harness may result in serious injury or death.

Be aware that falls can occur at anytime after leaving the ground.

ALWAYS read and understand the manufacturer's Warnings, expiration date (if applicable) and instructions on how to use and how to properly adjust the harness. Practice the use of a full body safety harness at ground level in the presence of a responsible adult to experience the feeling of hanging suspended before using in a hunting environment. Failure to follow harness instructions may result in not being able to return to the stand and being suspended in a harness after a fall, or serious injury or possibly death. If the hunting location is unknown by anyone and communication efforts are unsuccessful, you **MUST** have a personal plan for rescue/escape because prolonged suspension in a harness may be fatal. It is important to exercise the legs by pushing against the tree or doing other forms of continuous leg exercises to avoid blood pooling while being suspended. Hunters with varying degrees of physical fitness may require different plans to recover/escape the effects of prolonged suspension. Have a personal plan and practice it in the presence of a responsible adult before leaving the ground. No one escape/rescue plan will work for every hunter on every tree in every circumstance. Only you can determine the best recovery/escape plan for your situation before leaving the ground.

ALWAYS have a suspension relief device on your person and readily accessible while using a harness. These devices allow the user to relieve the load on the lower extremities if suspended in a harness and help maintain circulation in the legs, mitigate suspension trauma (blood pooling) or allow descent to the ground. Several optional products/systems are available that offer self-recovery or self-extraction from a fall when suspended in a harness. Some systems automatically descend the user while others allow user control. One of these products/systems can be considered for use as an additional safety precaution against prolonged suspension and suspension trauma. Be sure to follow the manufacturers' instructions on the safe use of these products/systems.

Hunt from the ground when self-recovery escape is absent. There is time to make a correct decision on what action to take if a fall occurs while wearing a full body harness. It is important to remember "**DO NOT PANIC.**" Remain calm and implement your practiced rescue, relief and recovery plan.

NEVER allow the tether strap to get under your chin or around our neck. The length of the harness tether **MUST** be minimized at all times. It should be adjusted so that it is above the head with no slack (snug) in the sitting position and you should have the minimum amount of slack possible when climbing.

WARNING

<p>ALWAYS read and understand all warnings and instructions before each use of this product. Failure to read and understand all warnings and instructions may result in serious injury or death.</p> <p>ALWAYS inspect the tree stand for signs of wear or damage BEFORE each use. Also inspect to ensure that nuts and bolts are secure and straps are not frayed, worn, or broken.</p> <p>DO NOT use treestand if combined weight of one person and equipment exceeds 300 lbs. or combined weight of two people and equipment exceeds 500 lbs. DO NOT exceed the weight of safety harness. DO NOT exceed the weight of safety harness. DO NOT use the treestand if you are wearing a Fall Arrest System (FAS) that does not meet TMA standards. DO NOT use the treestand if you are not wearing a Fall Arrest System (FAS) that meets TMA standards. DO NOT use the treestand if you are not wearing a Fall Arrest System (FAS) that meets TMA standards. DO NOT use the treestand if you are not wearing a Fall Arrest System (FAS) that meets TMA standards.</p>	<p>DO NOT use this tree stand while under the influence of alcohol, medication, or illegal substances. Use of tree stand while under the influence of any of these substances may result in serious injury or death.</p> <p>NEVER use this tree stand if you have a history of problems such as (but not limited to) dizziness, vertigo, or motion sickness. NEVER use this tree stand if you have a history of problems such as (but not limited to) dizziness, vertigo, or motion sickness. NEVER use this tree stand if you have a history of problems such as (but not limited to) dizziness, vertigo, or motion sickness.</p> <p>NEVER use this tree stand during inclement weather such as (but not limited to) thunderstorms, snowstorms, ice, or high winds that could create slippery or dangerous situations.</p> <p>DO NOT modify or alter your tree stand.</p>	<p>NEVER use this tree stand on a dead, leaning, loose barked tree or on a tree that may fall, break, or uproot. NEVER use this tree stand on a tree that may fall, break, or uproot. NEVER use this tree stand on a tree that may fall, break, or uproot.</p> <p>NEVER leave the ground without checking every ladder section connection. NEVER leave the ground without checking every ladder section connection. NEVER leave the ground without checking every ladder section connection.</p> <p>NEVER step up to the platform. Climbing aids such as stick ladders MUST extend above the platform of the hang-on to allow the user to step down on the platform. The Full Body Harness MUST always be attached to the tree even when stepping down into the tree stand.</p> <p>NEVER remove or deface warning labels.</p>
--	--	---

NEVER remove any safety warning stickers from this product.

Safety must be your first priority during the use of this product.

©2011 (rev 12/10)

CHOOSING A SAFE TREE

- **ALWAYS** thoroughly inspect the tree before installing your product. **DO NOT** install your TREE/LADDER STAND onto any dead or unsafe tree, telephone or utility pole, structural column, or man-made structure. Doing so may result in serious injury or death.
- **ALWAYS** select the proper tree for use with your TREE/LADDER STAND. Select a live straight tree that fits within size limits recommended (minimum tree diameter must be no less than 9 inches and maximum of 18 inches.). **DO NOT** rely on a branch for support.
- **DO NOT** select a tree in the dark or choose a tree in close proximity to a fence. You must not have any stumps or rocks beneath your tree.
- **NEVER** use TREE/LADDER STAND on a tree that is dead, diseased, leaning or on wet and uneven ground as the tree may fall, break or uproot.
- Your tree must not be wet, icy or slippery or on wet, swampy, or loose ground that allows the tree to be unstable. Check the ground under TREE/LADDER STAND to ensure it is firm and level.
- Be sure you have a level stand platform. Your tree must not lean or have any irregular shape.
- Tree must not have any loose or scaly bark or excessive vines, nails, screws, or any other sharp objects protruding that may sever webbing on product. Any surrounding trees must not lean or have dead limbs that may fall onto you or your product.
- **NEVER HURRY!!** While climbing a TREE/LADDER STAND, make slow, even movements no more than ten to twelve inches at a time. Make sure you have proper contact with tree and/or TREE/LADDER STAND every time you move. **On ladder tree stand, ALWAYS maintain three points of contact with each step and ALWAYS lean forward as you climb.**

PROPER CARE AND MAINTENANCE:

- Inspect for defects (damage, rot, corrosion, cracks, freezing, excessive heat, etc.) before every use is required. Do not use if damage is detected or suspected.
- Ameristep recommends periodically re-tightening and/or replacing hardware (supplied by Ameristep), including bolts, nuts, washers, rope, straps, cord, etc.

19' WRAPAROUND LADDERSTAND

MODEL: 51039/9427A

- Always Wear a Safety Harness with this Product
- Practice Using at Ground Level
- Weight Limit: 500 lbs.
- Tree Size: 9"-18" diameter



Top Section (1)

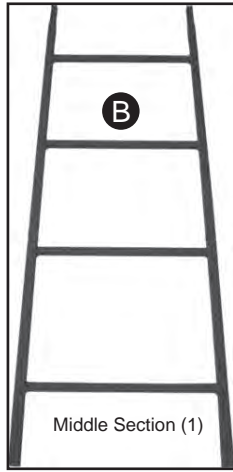

Middle Section (1)



Bottom Section (1)

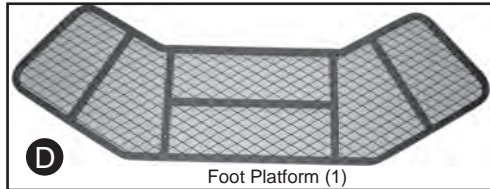

Foot Platform (1)

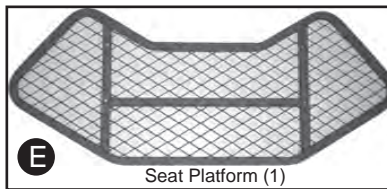

Seat Platform (1)

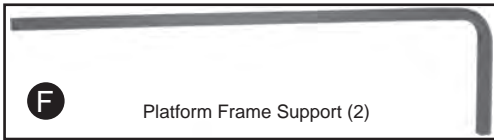

Platform Frame Support (2)

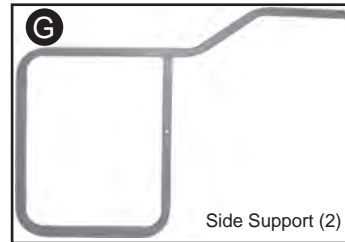

Side Support (2)

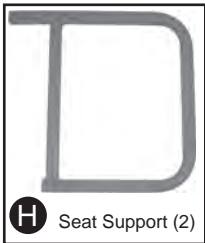

Seat Support (2)

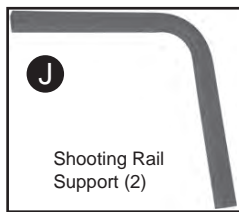

Shooting Rail Support (2)

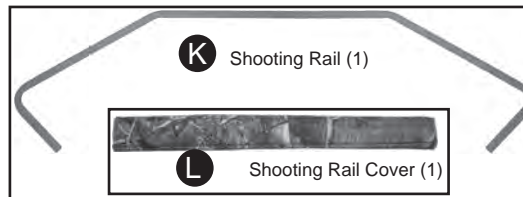

Shooting Rail (1)

Shooting Rail Cover (1)



Platform Brace (1)



Footrest (1)



Tree Connection Brace (2)

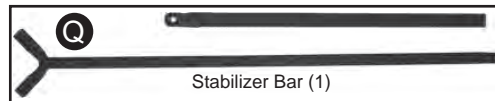

Stabilizer Bar (1)

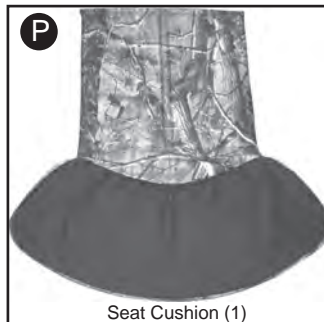

Seat Cushion (1)

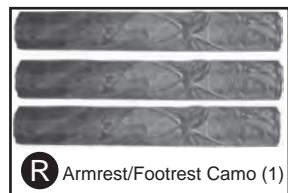

Armrest/Footrest Camo (1)

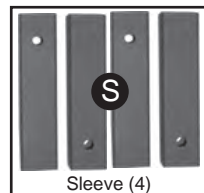

Sleeve (4)

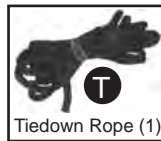

Tiedown Rope (1)



Ratchet Strap (2)

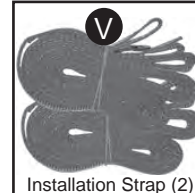

Installation Strap (2)

Parts List

A	1 Top Ladder Section	Part # GL-1550
B	1 Middle Ladder Section	Part # GL-2550
C	1 Bottom Ladder Section	Part # GL-3550
D	1 Foot Platform	Part # GP-550
E	1 Seat Platform	Part # GSP-550
F	2 Platform Frame Support	Part # GPFS-550
G	2 Side Support	Part # GSS-550
H	2 Seat Support	Part # GSS-555
J	2 Shooting Rail Support	Part # GSRS-550
K	1 Shooting Rail	Part # GSR-550
L	1 Shooting Rail Cover	Part # GPSC-550
M	2 Platform Brace	Part # GPB-550
N	1 Footrest	Part # GFR-550
O	2 Tree Connection Brace	Part # GTB-550
P	1 Seat Cushion	Part # GSC-550
Q	1 Stabilizer Bar	Part # GSB-500
R	3 Armrest/Footrest Cover	Part # GPAC-550
S	4 Sleeve	Part # GS-100
T	1 Tiedown Rope	Part # TR-1000
U	2 Ratchet Strap	Part # RA-100
V	2 Installation Cross Strap	Part # ICS-100
X	1 Adjustment Knob	Part # AK-100

Hardware

65	4 M12x65mm Bolt	Part # 1265
60	18 M12x60mm Bolt	Part # 1260
55	14 M12x55mm Bolt	Part # 1255
45w	1 M12x45mm Bolt w/wingnut	Part # 1245W
	2 Harness	Part # 3001
	6 M10 Quickclip	Part # 1615

Hardware Pack

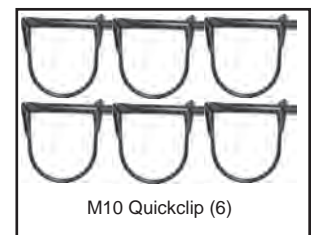
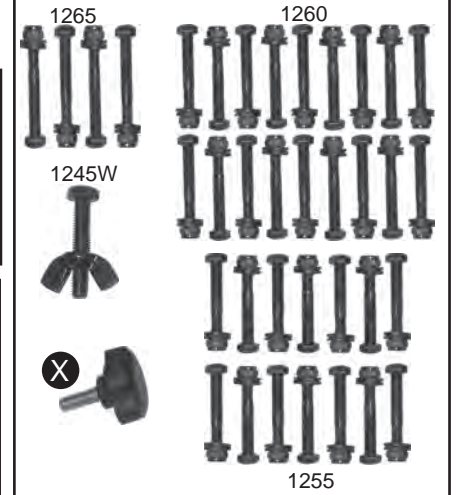

M10 Quickclip (6)

NOTE: ALL WASHERS ARE AGAINST THE BOLT HEAD AND THE NUT UNLESS STATED OTHERWISE

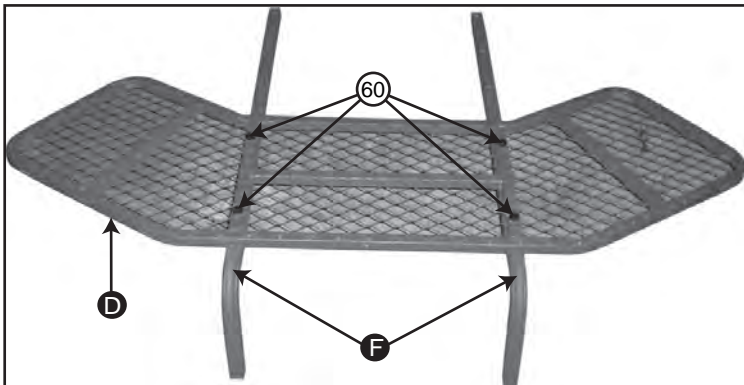

1. Attach Foot Platform **D** to the front of Platform Frame Supports **F** using **4-M12x60mm bolts**.

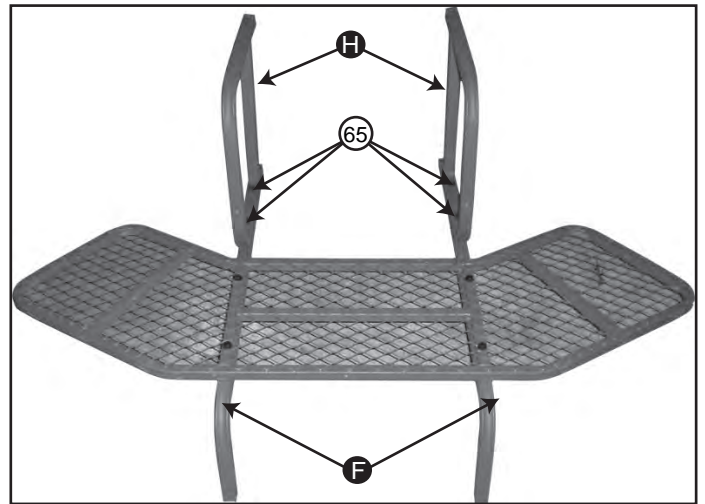

2. Attach one Seat Support **H** to the rear of each Platform Frame Support **F** using **2-M12x65mm bolt** on each side.

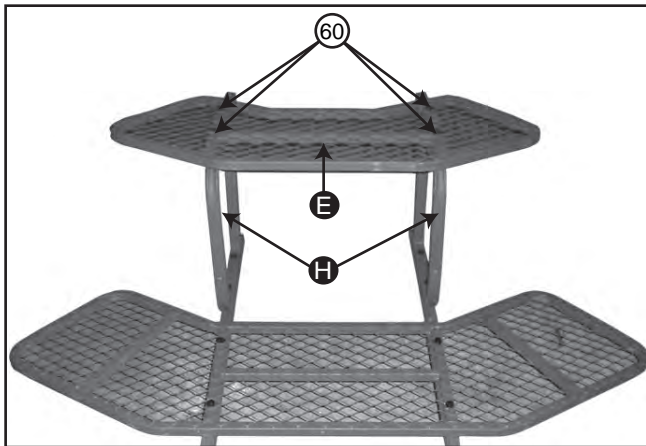

3. Attach Seat Platform **E** to the top of Seat Supports **H** using **4-M12x60mm bolts**.

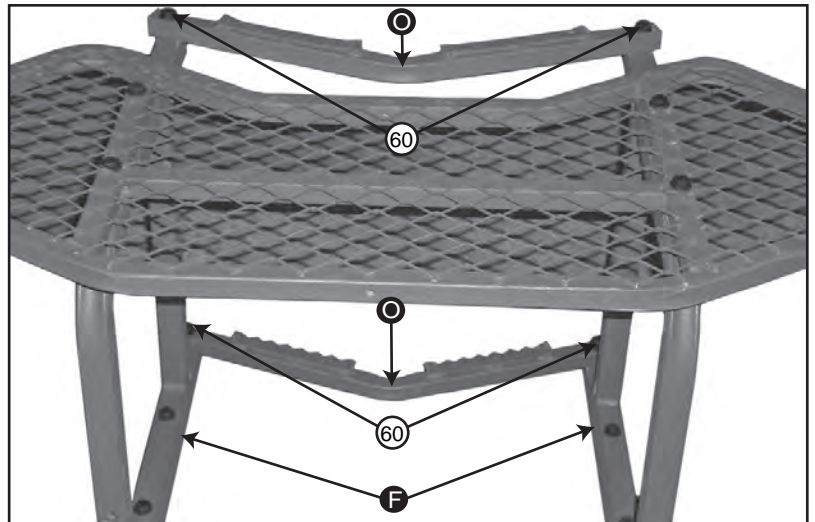

4. Attach one Tree Connection Brace **C** to the upper part of Seat Support **H** just behind the Seat Platform using **2-M12x60mm bolts**.

Attach the other Tree Connection Brace **C** to the lower part of Seat Support **H** using **2-M12x60mm bolts**.

NOTE: ALL WASHERS ARE AGAINST THE BOLT HEAD AND THE NUT UNLESS STATED OTHERWISE

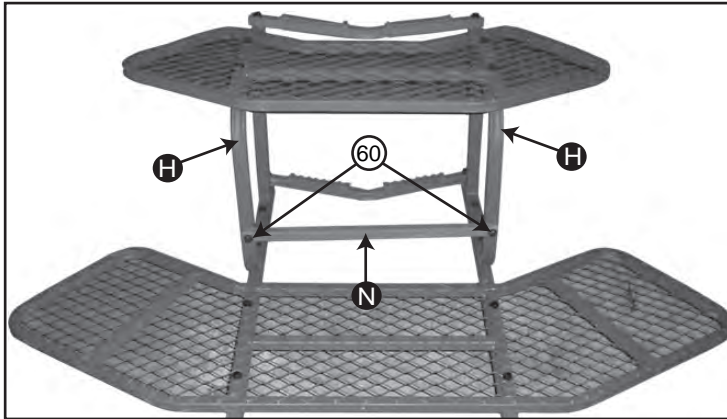

5. Attach Footrest **N** to the front of Seat Supports **H** using **2-M12x60mm bolts**.

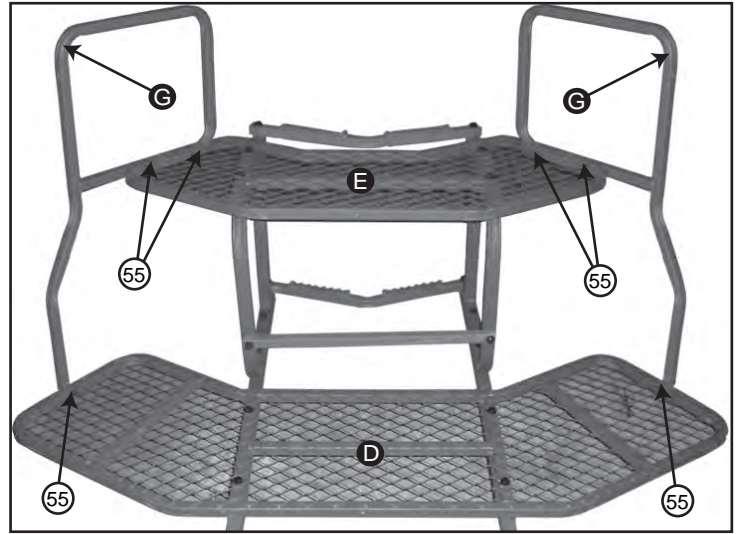

6. Attach angled bar of Side Support **G** to the side of Foot Platform **D** using **1-M12x55mm bolt**.

Attach squared part of Side Support **G** to the side of Seat Platform **E** using **2 -M12x55mm bolts**.

Repeat this step for the opposite side.

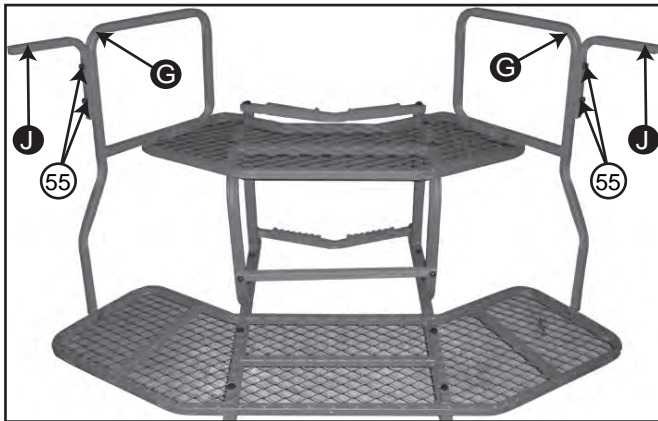

7. Attach Shooting Rail Support **J** to the front of Side Support **G** using **2-M12x55mm bolts** on each side.



8. Attach Shooting Rail **K** to the top of each Shooting Rail Support **J** using **2-M12x55mm bolts** on each side.

NOTE: ALL WASHERS ARE AGAINST THE BOLT HEAD AND THE NUT UNLESS STATED OTHERWISE

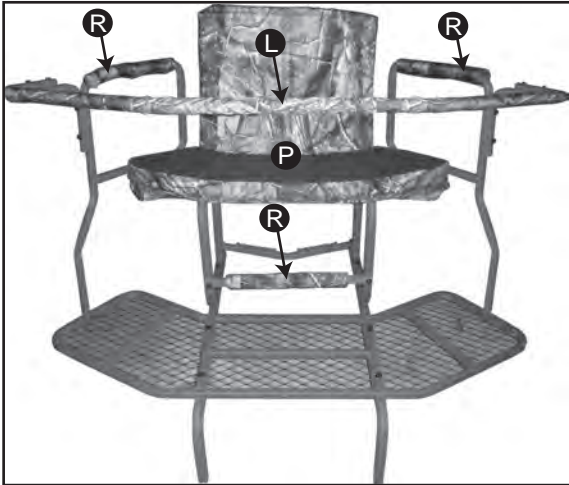

9. Attach Seat Cushion **P** to Seat Platform **E**.

Attach two Armrest Cover **R** to the top of each Side Support **G**.

Attach Footrest Cover **R** to Footrest **N**.

Attach Shooting Rail Cover **L** to Shooting Rail **K**.

10. Facing the rear of the stand, attach each Installation Strap **V** to the upper portion of Seat Support **H**, just behind the Tree Connection Brace. **(See Installation Strap Instructions)**

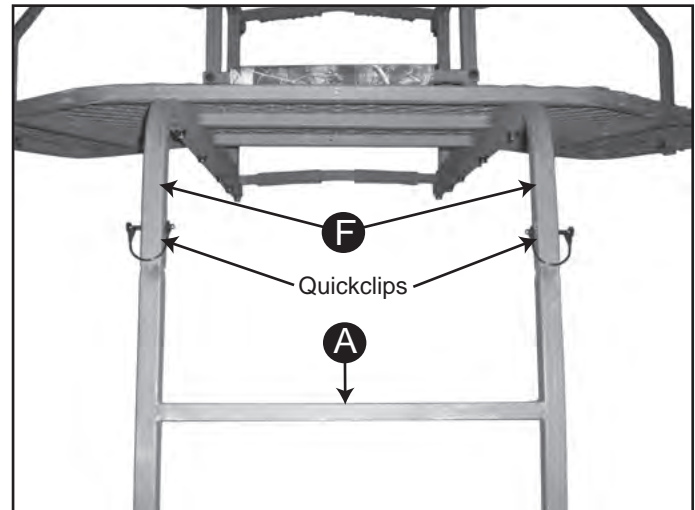
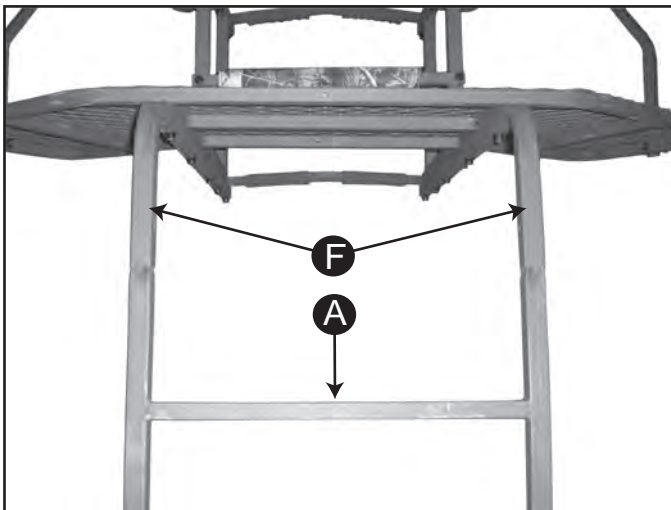

11. Slide Top Ladder Section **A** into Platform Frame Supports **F**.

(The Top Ladder Section has two holes on the sides of the ladder just below the top rung).

12. Insert two Quickclips through the Platform Frame Support **F** and Top Ladder Section **A**. Close the Quickclips to secure.

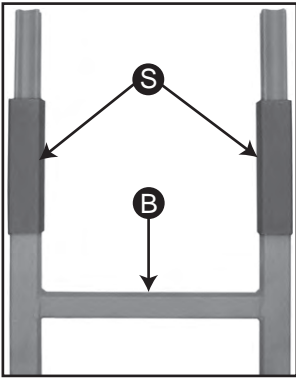

13. Slide Sleeves **S** over the crimps of Ladder Section **B**.

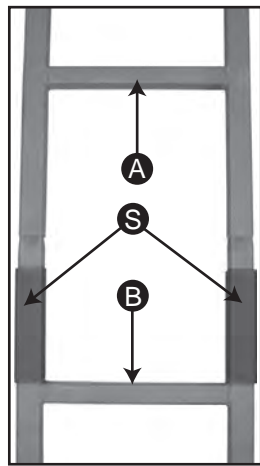

14. Insert Ladder Section **B** into Top Ladder Section **A**.



15. Slide the Sleeves over the joint where ladder sections are connected.

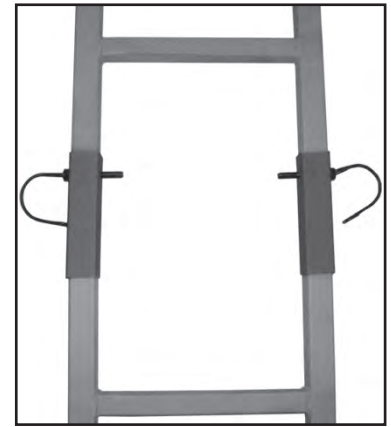

16. Insert 1 - **Quickclip** through the hole on the sleeve, and through the ladder sections on each side of the ladder.

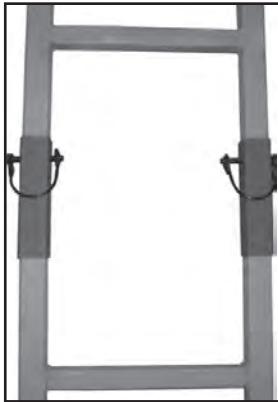

17. Close the quickclip to secure the ladder sections together.

18. Follow **Steps 13-17** to attach the bottom section to the middle section.

NOTE: ALL WASHERS ARE AGAINST THE BOLT HEAD AND THE NUT UNLESS STATED OTHERWISE

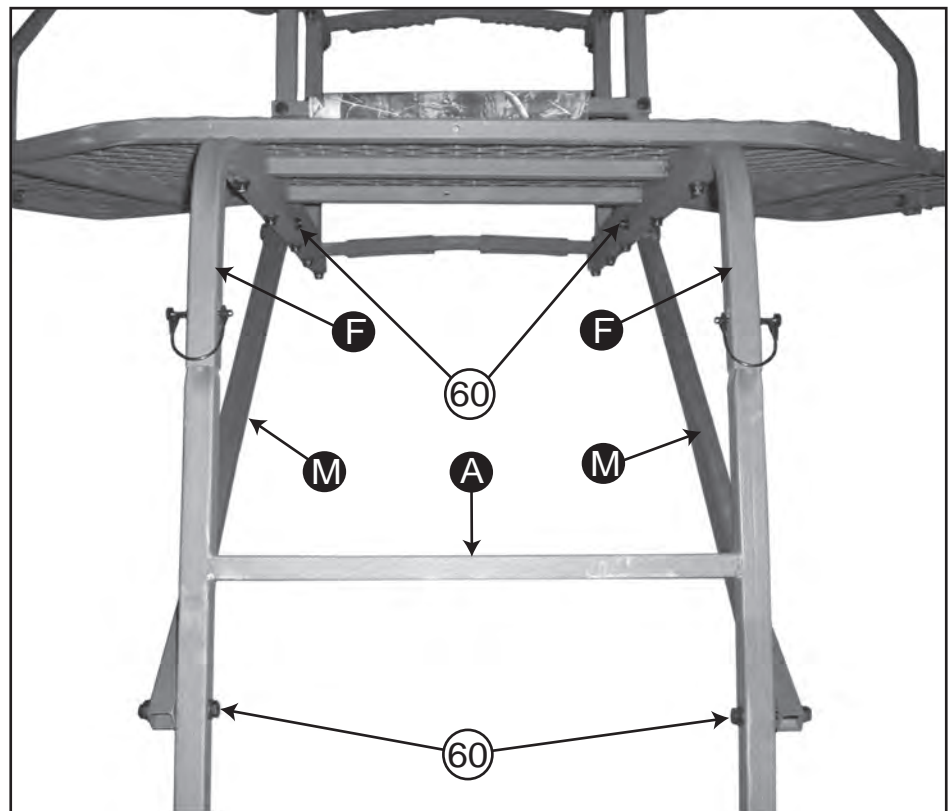

19. Attach Platform Brace **M** to Platform Frame Support **F** using **1-M12x60mm bolt** on each side. Attach the other side of Platform Brace **M** to Top Ladder Section **A**, just below the first rung, using **1-M12x60mm bolt** on each side.

NOTE: NOW THAT TREESTAND IS ASSEMBLED MAKE SURE TO TIGHTEN ALL HARDWARE



1. Attach Ratchet Straps **U** to the outermost corners of each Tree Connection Brace. See Ratchet Strap Instructions.

Attach Installation Straps **V** behind the the upper Tree Connection Brace. See Installation Strap Instructions.

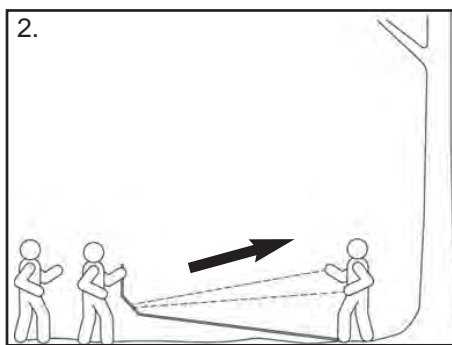

2. Position bottom of stand 4-5 feet from base of tree.

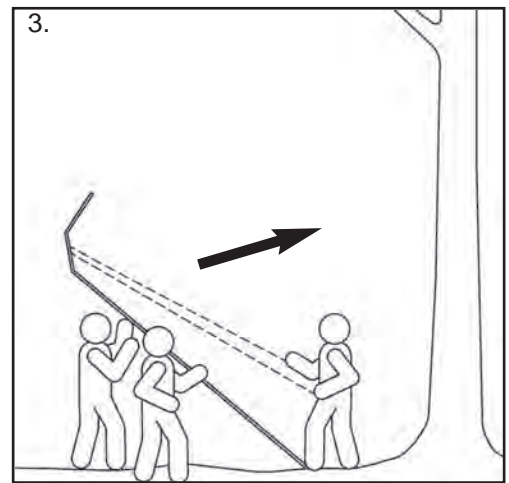

3. One person will stand at the base of ladder with his/her foot on bottom rung while holding installation straps. This will prevent tree stand from sliding. Two people will stand at opposite ends of tree stand, facing Platform and slowly walk tree stand upward using rungs of ladder.

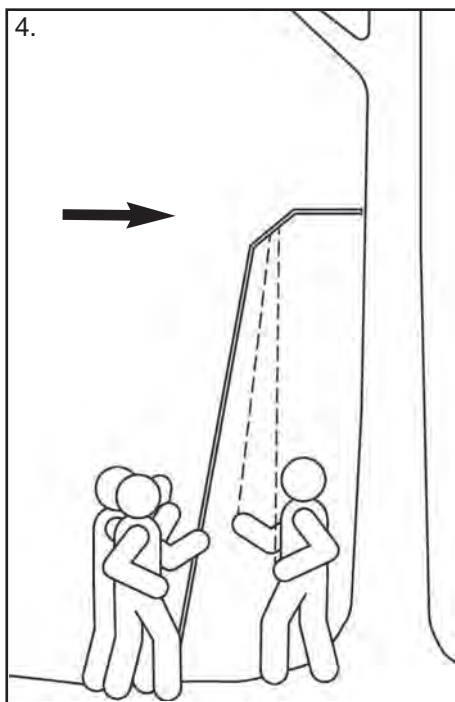

4. As tree stand is being raised, the person holding Installation Straps will pull toward themselves to take up slack. It will steady and ease the weight of stand on the other two people. Continue walking stand upward, until Tree Contact is resting against the tree.

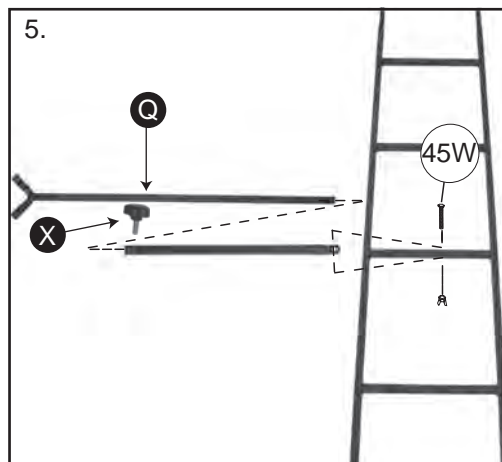

5. Slide the inner part of the Stabilizer Bar into the outer part. Attach Stabilizer Bar **Q** to the second rung of the Middle Ladder Section with 1 - **M12x45W bolt and 1 wingnut**.

Insert the Adjustment Knob **X** in the Stabilizer bar at the proper adjustment point to the tree.

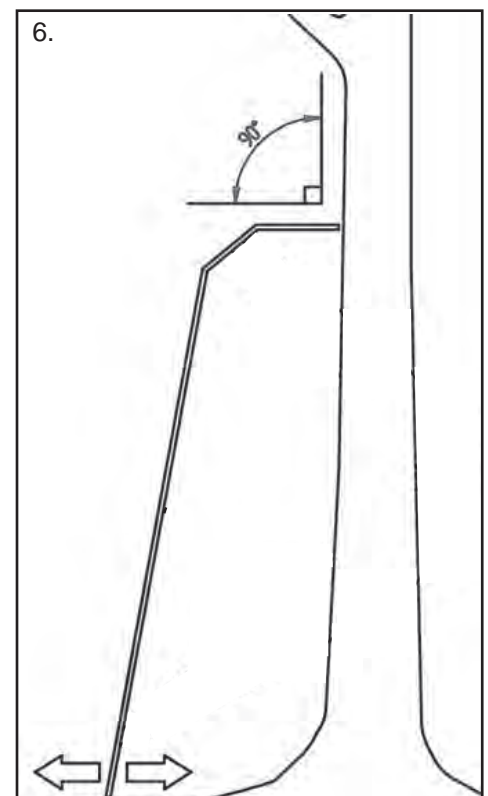

6. Move base of ladder toward or away from tree slightly in order to make Platform as parallel to the ground as possible.

Apply your full weight to the first step so it settles into the ground.

⚠ WARNING

Stabilizer Bar, Installation Straps and Ratchet Straps **MUST** be secured prior to climbing the treestand.

NOTE: Drawings are for illustration purposes only. Drawings may not depict actual product.

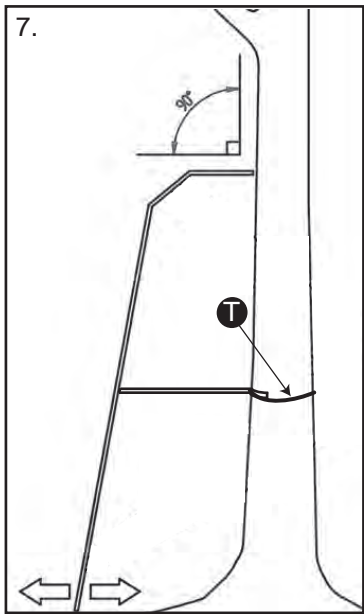

7. Slide the inner part of the Stabilizer Bar into the outer part. Position the Stabilizer Bar **Ⓢ** to the second rung of the middle ladder section with **1-M12x45mm bolt with wingnut**.

Position the Stabilizer bar against the tree.

Tie Tiedown Rope **Ⓣ** just behind the brace of the inner part of Stabilizer Bar.

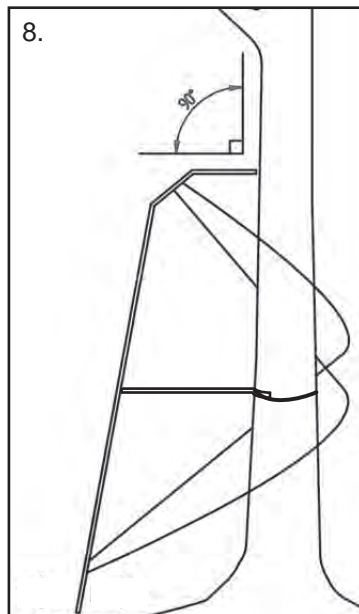

8. Cross Installation Straps behind tree. Attach to bottom ladder section by following the **Installation Strap Instructions**.



9. After the ladder stand has been secured to the tree with the installation straps, and the stabilizer bar has been securely attached to the tree, continue to have two people hold the ladder, climb cautiously up to the platform. Once you reach the top, **IMMEDIATELY ATTACH YOUR SAFETY HARNESS TO THE TREE**. Keep the tether strap above your head.

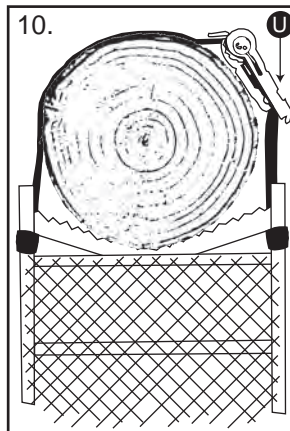

10. Cautiously climb to the top of the treestand. Wrap the strap of the ratchet around the back of the tree and thread it through the ratchet. (See Detailed Ratchet Instructions Below).

⚠ WARNING

Stabilizer Bar, Installation Straps and Ratchet Straps **MUST** be secured prior to climbing the treestand.

Detailed Ratchet Strap Instructions

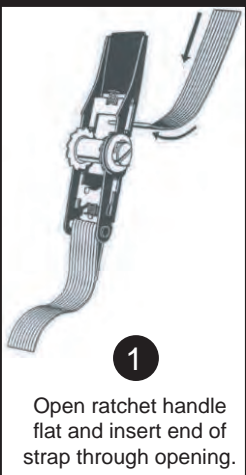

1

Open ratchet handle flat and insert end of strap through opening.

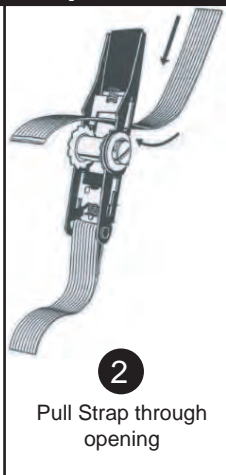

2

Pull Strap through opening

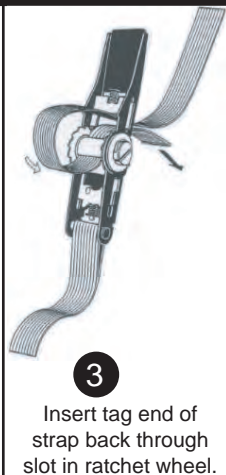

3

Insert tag end of strap back through slot in ratchet wheel.



4

Ratchet handle back and forth to tighten strap

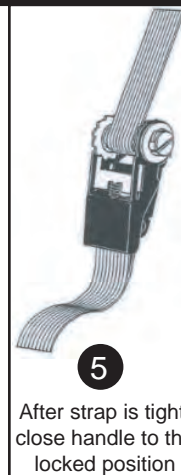

5

After strap is tight, close handle to the locked position



6

To release tension, push spring loaded retaining lock and simultaneously pull on strap.

⚠ WARNING DO NOT sit on seat platform until the ratchet has been secured.

Installation Strap Instructions

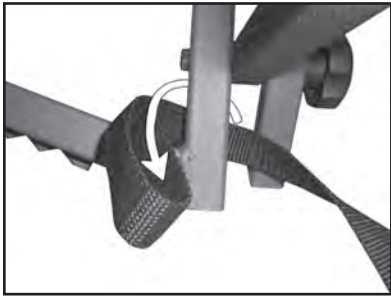

1. Place looped end of strap under platform.

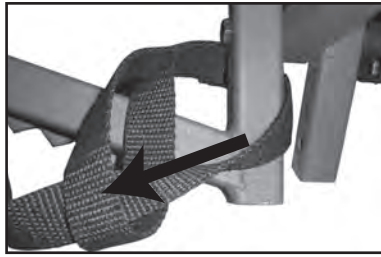

2. Insert loose end of strap through the loop.

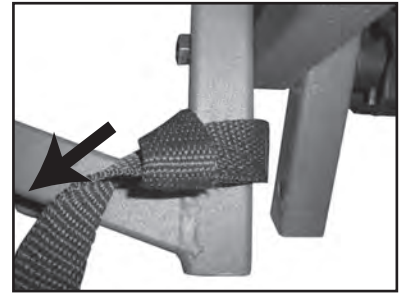

3. Pull to tighten. Continue with these steps to install the other strap on the other side of the platform.

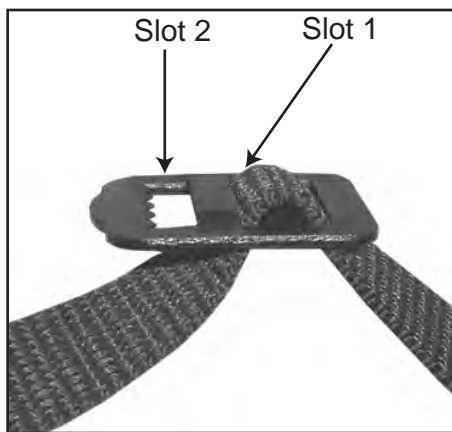

4. Place loose end of strap with clip, under the top rung of the bottom ladder section.

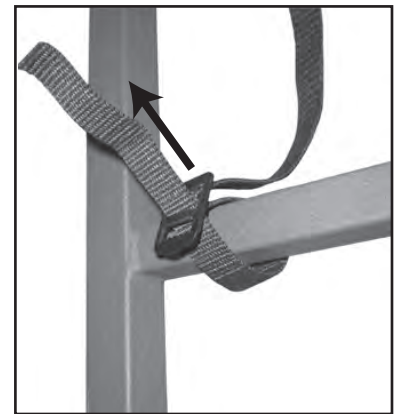

5. Insert the strap through Slot 1 on the clip.



6. Insert the strap through the Slot 2 with the teeth.

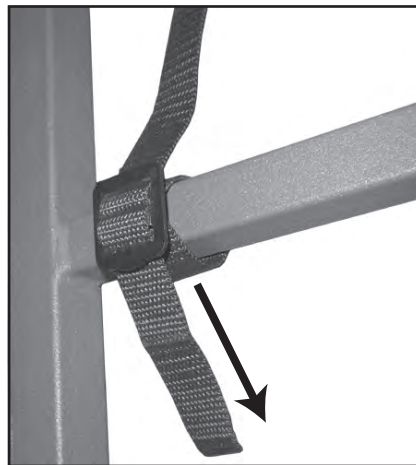

7. Pull strap to tighten.

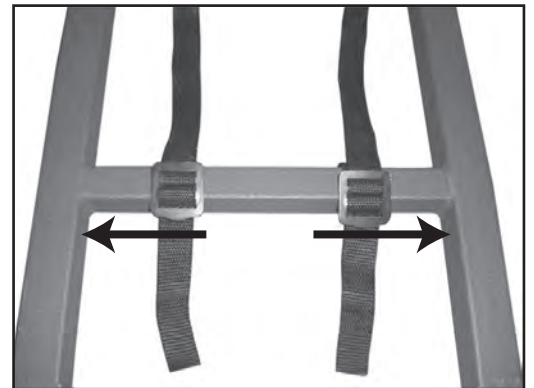

8. Slide the buckles out to the sides to create tension on the straps.

⚠ WARNING DO NOT sit on seat platform until the ratchet and installation straps have been secured.

Ratchet Strap Instructions

You **MUST** follow these instructions prior to installation

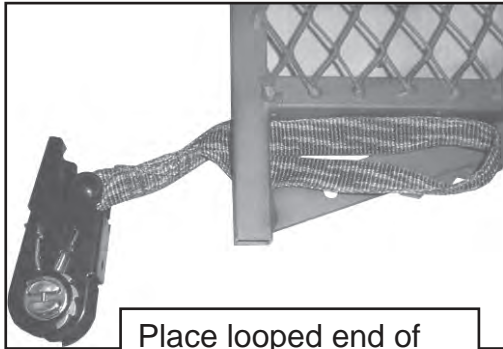

Place looped end of Ratchet under platform

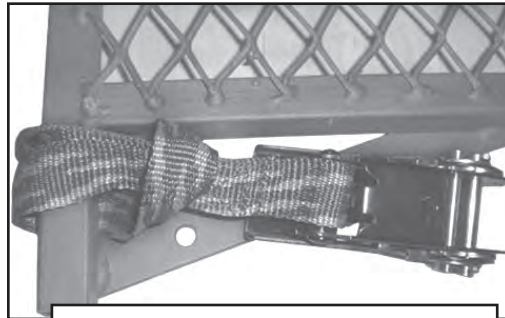

Insert ratchet through loop

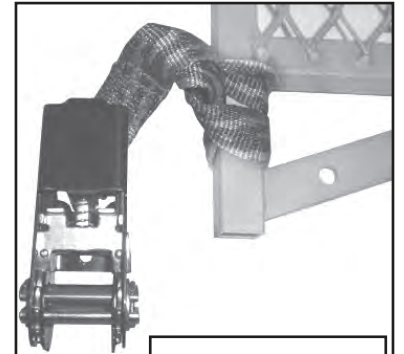

Pull to tighten

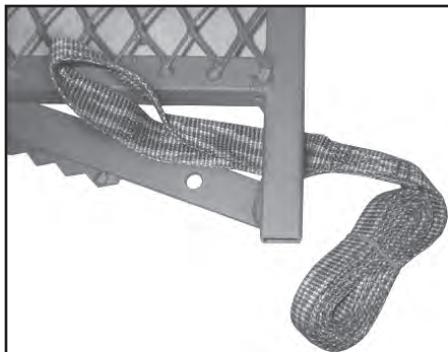

Place looped end of strap under platform

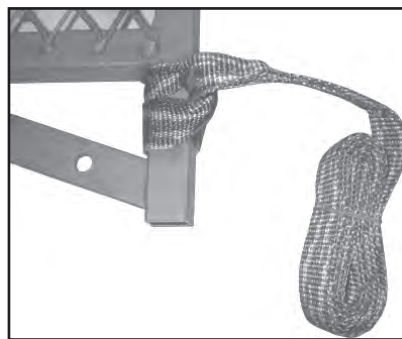

Insert strap through loop

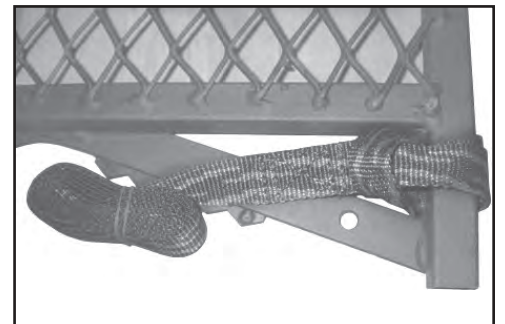

Pull to tighten

Detailed Ratchet Strap Instructions

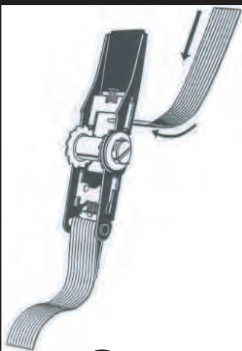

1

Open ratchet handle flat and insert end of strap through opening.

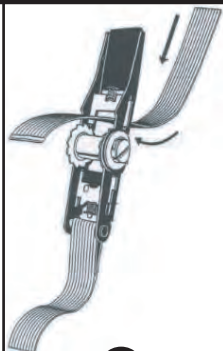

2

Pull Strap through opening

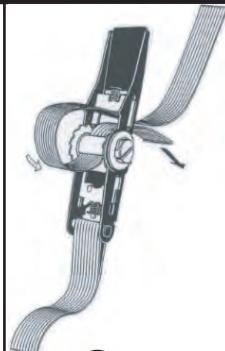

3

Insert end of strap through slot in ratchet wheel.

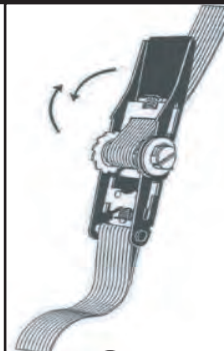

4

Ratchet handle back and forth to tighten strap

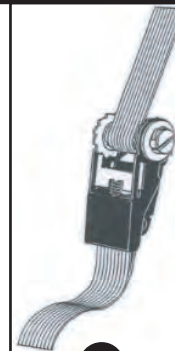

5

After strap is tight, close handle to the locked position

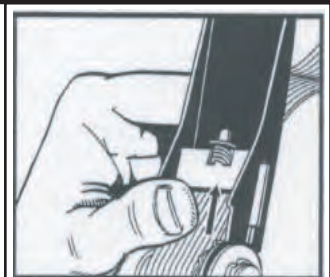

6

To release tension, push spring loaded retaining lock and simultaneously pull on strap.



WARNING

Failure to follow all warnings listed below could result in serious injury or death.

ALWAYS read and understand all warnings and instructions before each use of this product. Failure to read and understand all warnings and instructions may result in serious injury or death.

ALWAYS inspect the tree stand for signs of wear or damage **BEFORE** each use. Also inspect to ensure that nuts and bolts are secure and straps are not frayed, worn, or broken.

DO NOT use treestand if combined weight of one person and equipment exceeds **300 lbs.** or combined weight of two people and equipment exceed **500 lbs.** **DO NOT exceed the weight limit of safety harness, refer to harness manufacturers warnings for weight limit of safety harness.**

ALWAYS wear a Fall Arrest System (FAS) after leaving the ground. If you are not wearing an FAS that meets TMA standards, **DO NOT leave the ground.** Failure to wear an FAS may result in serious injury or death.

DO NOT use this tree stand while under the influence of alcohol, medication, or illegal substances. Use of tree stand while under the influence of any of these substances may result in serious injury or death.

NEVER use this tree stand if you have a history of health problems such as (*but not limited to*) heart problems, back problems, impaired vision, equilibrium impairments are afraid of heights or have been advised by a doctor not to do any strenuous activity. If you are feeling ill, nauseous, or dizzy **DO NOT** use this tree stand or If you are not physically fit, well rested and alert. Physical ailments can reduce your ability to safely install, utilize and remove your tree stand.

NEVER use this tree stand during inclement weather such as (but not limited to) thunderstorms, snowstorms, hurricanes, icy conditions, or high winds that could create slippery or dangerous situations.

NEVER use this tree stand on a dead, leaning, loose barked tree or on a utility pole as the tree may fall, break, or uproot and may result in serious injury or death.

NEVER leave the ground without checking every ladder section connection to ensure they are firmly connected. If ladder sections are separating, with the help of at least two other people, remove the tree stand from the tree, tighten all connections and reinstall on the tree.

Installation Straps, Ratchet Straps, Quickclips, Tiedown Ropes and Stabilizer Bars MUST be installed and secured prior to climbing tree stand. Failure to comply may result in serious injury or death.

DO NOT modify or alter your tree stand.

NEVER remove or deface warning labels.

Manufactured in the year 2011

Primal Vantage Company Inc. 685 Route 10 East, Randolph, NJ 07869 1-866-972-6168 Contact for replacement labels

Item #'s HEH00535, HEH00536, HEH00537, 51031/9426, 51039/9247