

# THE GUNNER

## 16' LADDER TREESTAND

MODEL: 51007/9602A

- Practice Using at Ground Level
- Weight Limit: 300 lbs.
- Tree Size: 9"-18" diameter
- Always Wear a Safety Harness with this Product

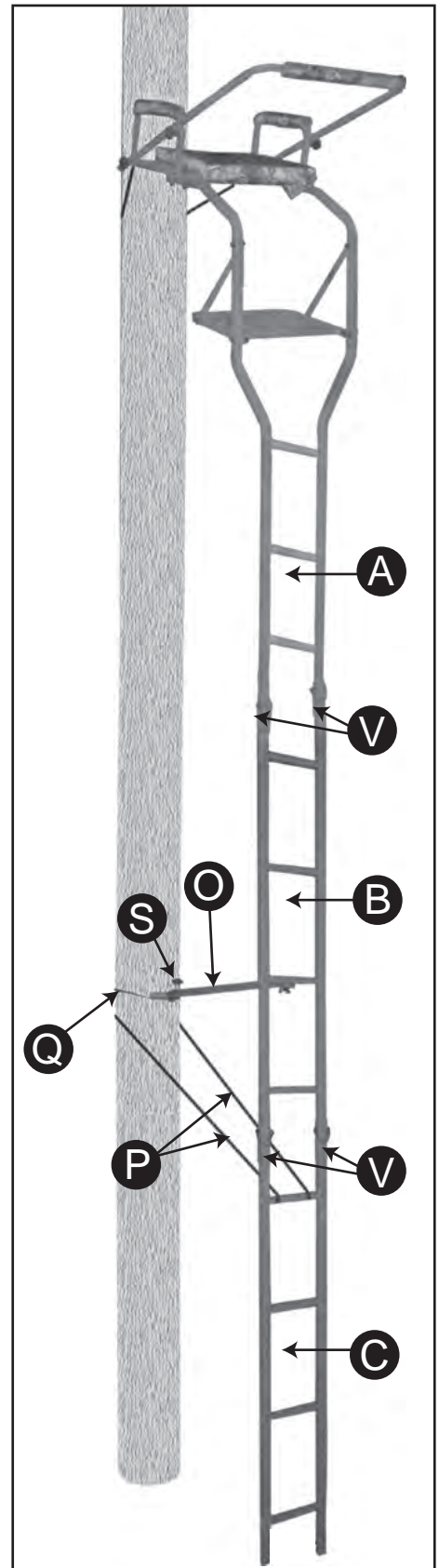
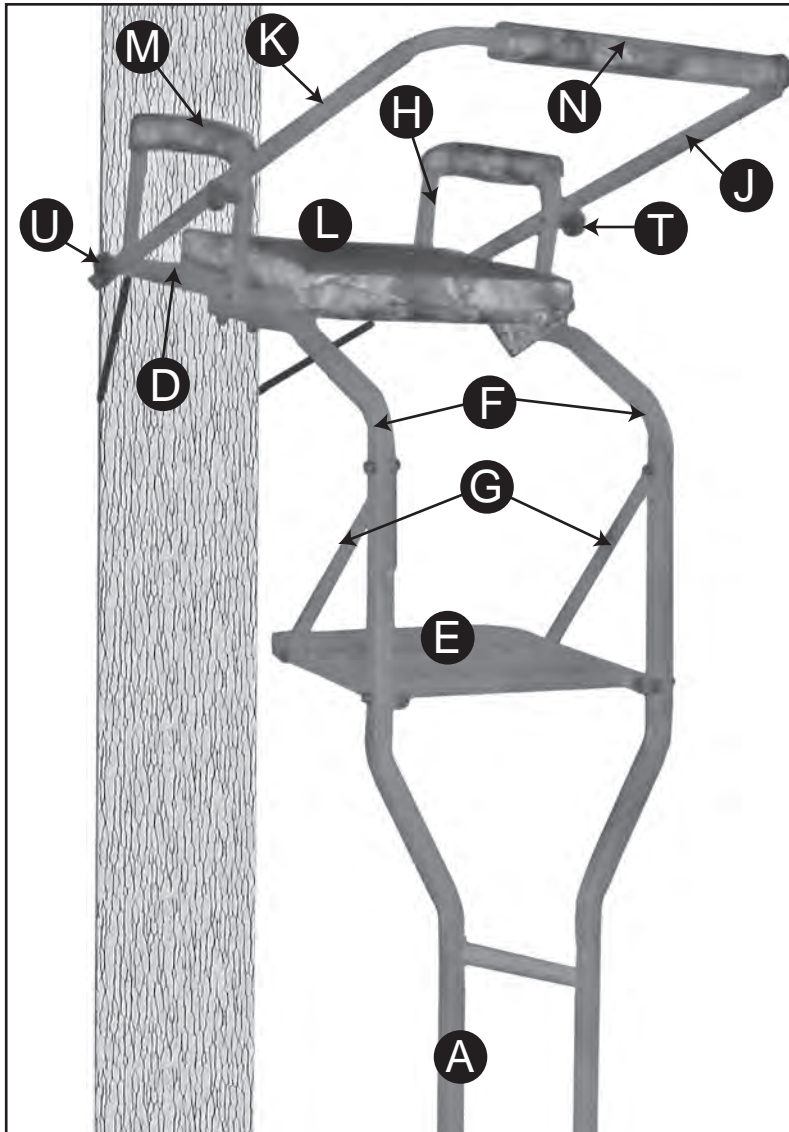

THANK YOU! for purchasing Ameristep's 16ft Gunner Ladder Treestand

### ⚠ Warning

Every year serious injury and even death occurs from hunting related falls. To ensure your safety, please **COMPLETELY** read and follow this safety manual and ALL warning labels **BEFORE** assembling, installing or utilizing this product.

DO NOT USE THIS PRODUCT BEFORE FULLY UNDERSTANDING ALL SAFETY WARNINGS AND INSTRUCTIONS. IF YOU HAVE QUESTIONS, ARE UNSURE ABOUT ANY INFORMATION OR NEED ADDITIONAL INFORMATION CONCERNING YOUR PRODUCT, CONTACT OUR CUSTOMER SERVICE DEPARTMENT AT 1-866-972-6168 OR VISIT [WWW.TREESTANDCUSTOMERSERVICE.COM](http://WWW.TREESTANDCUSTOMERSERVICE.COM). KEEP AND MAINTAIN THIS SAFETY AND INSTRUCTION MANUAL IN A SAFE LOCATION FOR FUTURE REFERENCE.

## TREESTAND SAFETY WARNINGS

Please read the following instruction manual and warnings labels completely before utilizing this product. Failure to understand and execute the instructions and warnings may result in serious injury or death. In the event of an accident, have a plan for rescue, including the use of devices that may be easily reached while suspended.

**ALWAYS** read and understand all warnings and instructions and use all safety products provided before each use of this product. Failure to read and understand all warnings and instructions may result in serious injury or death. Contact a Customer Service Representative with any questions you may have.

**NEVER** exceed total weight limit of **300 lbs.** **DO NOT** use if your combined weight with all of your hunting gear and any accessories exceeds **300 lbs.** Use of tree stand over the weight limit may result in serious injury or death.

**DO NOT** use this tree stand while under the influence of alcohol, medication or any illegal substances. Use of tree stand while under the influence of any of these substances may result in serious injury or death.

**NEVER** use this treestand during inclement weather. **DO NOT** use tree stand during thunderstorms, snowstorms, hurricanes, tornadoes or any other weather conditions that include (but not limited to) lightning, icy conditions, or high winds that could create slippery or dangerous situations. End your hunt and return to the ground if inclement weather conditions arise.

**NEVER** use treestand if you are feeling ill, nauseous, dizzy or if you have a prior condition that could cause a problem. i.e., heart condition, joints that lock-up spinal fusions, etc., or if you are not well rested and alert. Physical ailments can reduce your ability to safely install, utilize, and remove your treestand. Please consult a physician prior to use.

**NEVER** use this tree stand if you have a history of health problems such as (but not limited to) heart problems, back problems, high blood pressure, impaired vision, equilibrium impairments, are afraid of heights, have been advised by a doctor or physician not to climb. If you are not physically fit, well rested, and alert, or if you have any other physical or mental condition that would impair your ability to properly use this treestand.

**NEVER** use this tree stand on a tree that is dead, leaning, diseased, loose barked or on a utility pole as the tree may fall, break, or uproot and may result in serious injury or death.

**NEVER** rely on a branch for support.

**NEVER** jump or bounce on the treestand's platform or ladder sections to seat it to the tree. Instead, step firmly on the first rung of the bottom ladder section to set the ladder into the ground before proceeding to climb the ladder.

**NEVER** transport any of your equipment with yourself while ascending or descending the tree. You will need to have two hands free during ascending and descending for safety. Use a haul line to pull up your firearm (unloaded, chamber opened with safety lock engaged, barrel facing towards the ground), bows, arrows, knives or any other equipment to your tree stand once you have reached your desired hunting height. **ONLY** pull up hunting equipment after the tree stand has been secured to the tree and after you and your harness have been secured to the tree. Prior to descending, lower your equipment on the opposite side of the tree from which you are climbing. Make sure that the unloaded firearm's safety lock is engaged and the gun barrel is pointing towards the ground.

**ALWAYS** hunt with a plan and a buddy. Before you leave home, let others know your exact location, when you plan to return and who is with you.

**ALWAYS** carry emergency signal devices such as a cell phone, walkie-talkie, whistle, signal flare, PLD (personal location device) and flashlight with you at all times and within reach even while you are suspended in your harness. Watch for changing weather conditions. In the event of an accident, remain calm and seek help immediately.

**ALWAYS** inspect the tree stand and the Fall Arrest System (FAS) (Harness) for signs of wear or damage **BEFORE** each use. Also inspect to ensure that nuts and bolts are secure. Pay special attention to the harness and straps, guaranteeing that nothing has been frayed or severed. Destroy all products that cannot be repaired by the manufacturer. Contact a Customer Service Representative for replacement parts. The Fall Arrest System **MUST** be discarded and replaced after a fall has occurred.

**NEVER** modify your treestand in any way by making repairs, replacing parts, or altering adding or attaching anything to it except if explicitly authorized in writing by the manufacturer. Improper installation or adjustment may cause serious injury or death. Remove all contents from box. Inspect for any damaged or missing parts. If any parts are missing or damaged, you must only use certified replacement parts. Using any other replacement parts will void product warranty. **THERE ARE NO EXTRA PARTS.** All parts **MUST** be used to ensure the safety of you and your stand. If you think parts are missing or damaged, **STOP IMMEDIATELY** and contact our Customer Service Department. Using the tree stand with missing or damaged parts may result in serious injury or death. Contact a Customer Service Representative if you have any missing, damaged or extra parts.

**PRACTICE** installing, adjusting and using your treestand at ground level prior to using it at an elevated position.

**ALWAYS** keep instructions (written and video) in a safe place and review before each use. It is the responsibility of the treestand owner to furnish the complete instructions to anyone who borrows or purchases the treestand from you.

**NEVER** use this treestand for any use other than hunting. Our treestands are designed for hunter's to wear a Full Body Harness. If you are not completely comfortable and confident with your ability to safely install, ascend, hunt and descend using a Full Body Safety Harness and this treestand, **DO NOT PROCEED.**

**NEVER** use this treestand for trimming trees.

**NEVER** fall asleep in your stand as you may fall out resulting in serious injury or death.

**ALWAYS** be sure to retighten all bolts **BEFORE** each new use of treestand.

**ALWAYS** have a minimum of three people present when installing or removing this treestand.

## TREESTAND SAFETY WARNINGS

**NEVER** adjust your stand while in use. Practice the attachment of this treestand at ground level before using in a hunting environment. **ALWAYS** ensure that you and your treestand are safely secured to a healthy tree. Your tree stand **MUST** be attached tightly to the tree and secured in place. If the stand is not secure, it may shift while in use, resulting in serious injury or death.

The Installation Cross Straps and Stabilizer Bar(s) **MUST** be properly installed before each use of the treestand.

**ALWAYS** inspect every ladder section connection every time you use the stand before you leave the ground. If ladder sections are separating, with the help of at least two other people, lower the stand to the ground, make adjustments, and reinstall.

**ALWAYS** check the ground below the tree stand to make sure it is firm and level. Sloping ground or uneven terrain (one side of a rock or root) can cause your tree stand to tilt or shift.

**ALWAYS** maintain three points of contact when climbing the tree stand. (Two feet and one hand **or** one foot and two hands.)

**ALWAYS** lean forward as you climb and attach your harness to the tree before securing the platform to the tree and stepping onto the platform.

**DO NOT** leave your treestand outside since weather or animals may cause damage. Tree growth can also cause stress and damage straps and buckles. It must be stored inside when not in use.

**NEVER** wear jewelry or loose fitting clothing, which can cause hazardous conditions. Clothing may be caught in your equipment and cause you to fall. You must always wear non-slip or rubber boots. Shoelaces must be tucked into your boots. Rings and necklaces **MUST NOT** be worn.

**NEVER** use this treestand with a second person. The treestand is designed for use by **ONE** person.

**NEVER** let children play with or use this treestand without adult supervision. This treestand is not a toy.

**DO NOT** use tree stand if any nuts or bolts or parts are loose, bent, or crooked.

**ALWAYS** know your physical limitations. Don't take chances. If you start thinking about how high you are, don't go any higher. Instead, choose a minimum height that will allow for safe, effective and comfortable hunting.

**ALWAYS** lean **forward towards the tree** as you climb and attach your harness to the tree **BEFORE** securing the platform to the tree and stepping onto the platform. **NEVER** lean out from the treestand for any reason.

**ALWAYS** wear a Fall Arrest System (FAS) (Harness) consisting of a full body safety harness after leaving the ground. A TMA Certified Full Body Harness **MUST** always be connected to yourself and the tree during ascending, hunting and descending. Single safety belts and chest harnesses are no longer allowed and should **NEVER** be used. If you are not wearing a Full Body Harness properly attached to the tree, that is protecting you from a fall, **DO NOT leave the ground**. Failure to wear your Full Body Harness may result in serious injury or death.

Be aware that falls can occur at anytime after leaving the ground.

**ALWAYS** read and understand the manufacturer's Warnings, expiration date (if applicable) and instructions on how to use and how to properly adjust the harness. Practice the use of a full body safety harness at ground level in the presence of a responsible adult to experience the feeling of hanging suspended before using in a hunting environment. Failure to follow harness instructions may result in not being able to return to the stand and being suspended in a harness after a fall, or serious injury or possibly death. If the hunting location is unknown by anyone and communication efforts are unsuccessful, you **MUST** have a personal plan for rescue/escape because prolonged suspension in a harness may be fatal. It is important to exercise the legs by pushing against the tree or doing other forms of continuous leg exercises to avoid blood pooling while being suspended. Hunters with varying degrees of physical fitness may require different plans to recover/escape the effects of prolonged suspension. Have a personal plan and practice it in the presence of a responsible adult before leaving the ground. No one escape/rescue plan will work for every hunter on every tree in every circumstance. Only you can determine the best recovery/escape plan for your situation before leaving the ground.

**ALWAYS** have a suspension relief device on your person and readily accessible while using a harness. These devices allow the user to relieve the load on the lower extremities if suspended in a harness and help maintain circulation in the legs, mitigate suspension trauma (blood pooling) or allow descent to the ground. Several optional products/systems are available that offer self-recovery or self-extraction from a fall when suspended in a harness. Some systems automatically descend the user while others allow user control. One of these products/systems can be considered for use as an additional safety precaution against prolonged suspension and suspension trauma. Be sure to follow the manufacturers' instructions on the safe use of these products/systems.

Hunt from the ground when self-recovery escape is absent. There is time to make a correct decision on what action to take if a fall occurs while wearing a full body harness. It is important to remember "**DO NOT PANIC.**" Remain calm and implement your practiced rescue, relief and recovery plan.

**NEVER** allow the tether strap to get under your chin or around our neck. The length of the harness tether **MUST** be minimized at all times. It should be adjusted so that it is above the head with no slack (snug) in the sitting position and you should have the minimum amount of slack possible when climbing.

# WARNING

**DO NOT** use this ladderstand without reading and following all warnings and instructions before each use. Failure to do so may result in serious injury or death.

**ALWAYS** inspect your ladderstand before each use. **DO NOT** use if parts are missing, worn, or damaged.

**ALWAYS** wear a Full Body Harness while using this ladderstand. Failure to wear a full body harness while using this ladderstand may result in serious injury or death.

**DO NOT** exceed the ladderstand's 300 lbs. weight limit which includes your body weight as well as the weight of your clothes and gear. Exceeding the ladderstand's weight limit may cause the treestand to break or fail resulting in serious injury or death.

**NEVER** stand on treestand seat or any other part of the treestand. Failure to do so may result in serious injury or death.

**NEVER** alter, modify, or repair the ladderstand. Failure to do so may result in serious injury or death.

**NEVER** use the treestand on a tree that is cracked, diseased, leaning, or on weak, dead, or rotten wood. The tree may fall, break, or be uprooted by wind, resulting in serious injury or death.

**NEVER** use ladderstand during inclement weather. **DO NOT** use treestand during thunderstorms or any other weather conditions including (but not limited to) lightning, freezing rain, high wind that could create slippery or dangerous conditions.

**DO NOT** use ladderstand under the influence of alcohol, drugs, or medication. Using ladderstand under the influence of alcohol, drugs, or medication may result in serious injury or death.

**DO NOT** use ladderstand if you have dizzy spells, a heart problem, are afraid of heights, have been advised by a doctor or other health care provider not to climb, or have any condition that would impair your ability to climb up or down or use treestand as it could result in serious injury or death.

**NEVER** remove or deface ladderstand warning labels. Replacement labels can be obtained from the address below.

Tahsin Industrial Corp. USA 1000 Route 10 East - Randolph, NJ 07869 - Visit [www.treestandcustomerservice.com](http://www.treestandcustomerservice.com) or call 1-866-972-6168 - Manufactured in the year XXX

**NEVER** remove any safety warning stickers from this product.

**Safety must be your first priority during the use of this product.**

• **ALWAYS** thoroughly inspect the tree before installing your product. **DO NOT** install your TREE/LADDER STAND onto any dead or unsafe tree, telephone

# THE GUNNER

## 16' LADDER TREESTAND

MODEL: 51007/9602A

- Practice Using at Ground Level
- Weight Limit: 300 lbs.
- Tree Size: 9"-18" diameter
- Always Wear a Safety Harness with this Product

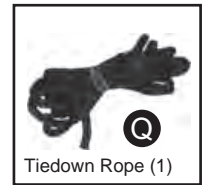
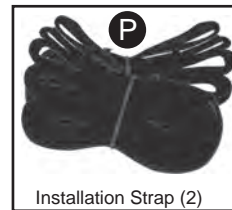
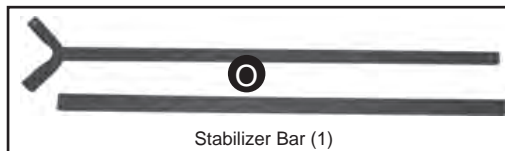
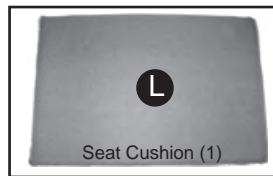
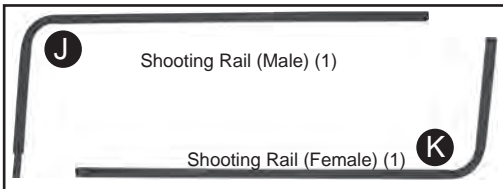
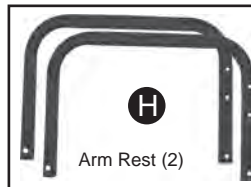
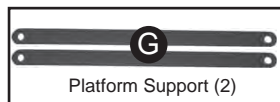
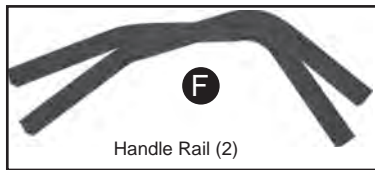
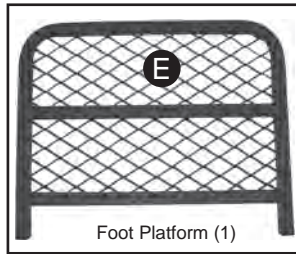
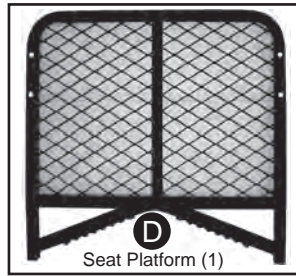
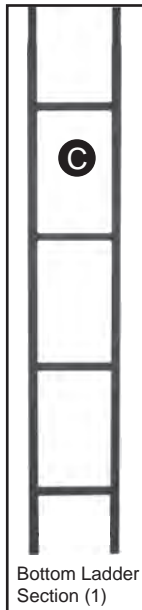

### Hardware Blister Pack

1260  
1050  
1245W  
1240

Hardware is layed out as found in blister pack

U  
T  
S

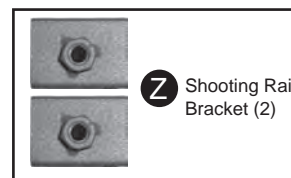
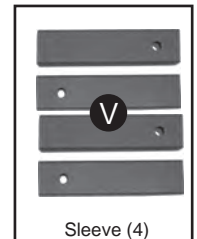

## Parts List

<b>A</b>	1 Top Ladder Section	Part # WFL-3001
<b>B</b>	1 Middle Ladder Section	Part # WFL-3251
<b>C</b>	1 Bottom Ladder Section	Part # WFL-3502
<b>D</b>	1 Seat Platform	Part # WSP-302
<b>E</b>	1 Foot Platform	Part # WFP-300
<b>F</b>	2 Handle Rail	Part # WHR-300
<b>G</b>	2 Platform Support	Part # WPS-300
<b>H</b>	2 Arm Rest	Part # WAR-301
<b>J</b>	1 Shooting Rail (Male)	Part # WSR-300
<b>K</b>	1 Shooting Rail (Female)	Part # WSR-350
<b>L</b>	1 Seat Cushion	Part # WSC-301
<b>M</b>	2 Arm Rest Cover	Part # WPAC-300
<b>N</b>	1 Shooting Rail Cover	Part # WPSC-300
<b>O</b>	1 Stabilizer Bar	Part # WSB-200
<b>P</b>	2 Installation Cross Strap	Part # ICS-1000
<b>Q</b>	1 Tiedown Rope	Part # TR-1000
<b>R</b>	1 Ratchet Strap	Part # RA-100
<b>S</b>	1 Adjustment Knob	Part # AK-100
<b>T</b>	2 Shooting Rail Knob	Part # SRK-301
<b>U</b>	2 Short Knob	Part # SK-301
<b>V</b>	4 Sleeve	Part # WS-100
<b>Z</b>	2 Shooting Rail Bracket	Part # SRB-100

## Hardware

<b>(60)</b>	6 M12x60mm Bolt	Part # 1260
<b>(40)</b>	4 M12x40mm Bolt	Part # 1240
<b>(50)</b>	2 M10x50mm Bolt	Part # 1050
<b>(45w)</b>	1 M12x45mm w/wingnut	Part # 1245W
	1 Harness	Part # 3001
	4 M10 Quickclips	Part # 1615

## You Will Need

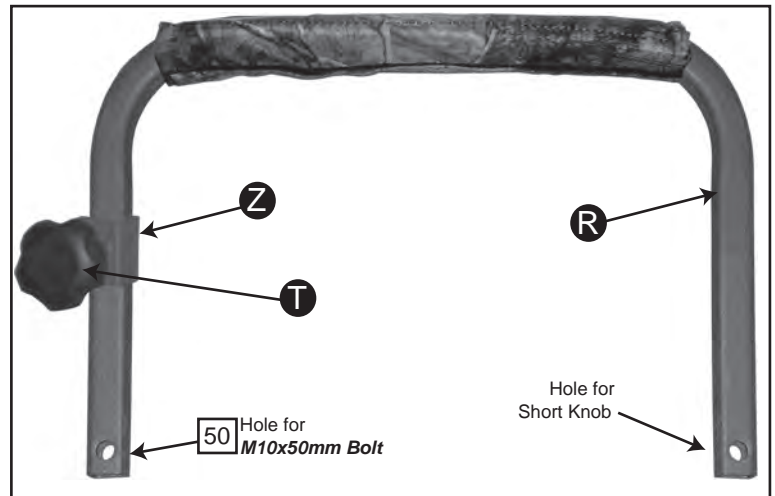
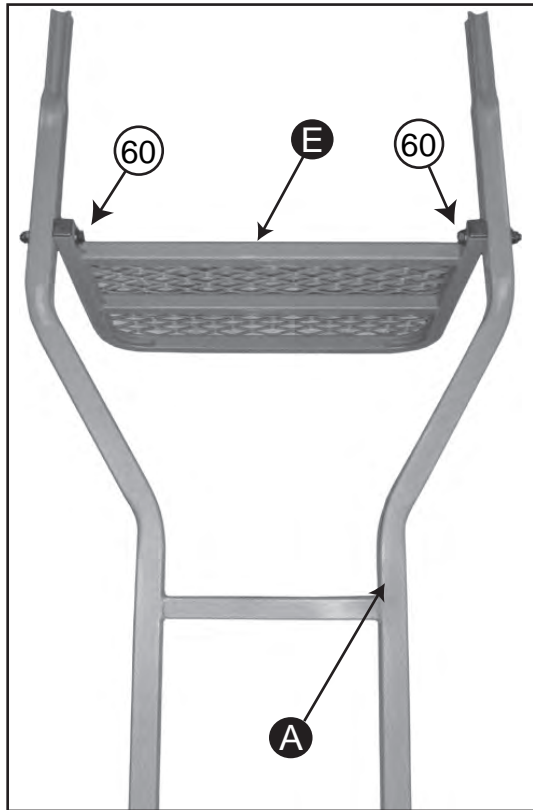
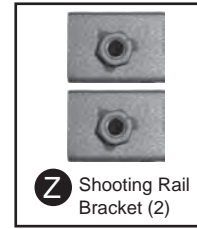
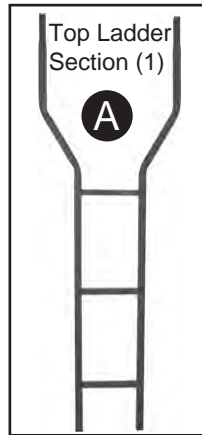
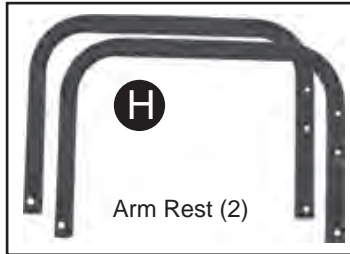
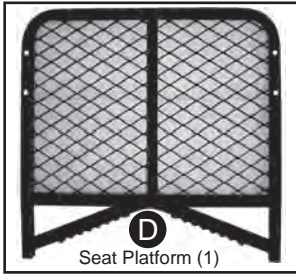

2. Attach Arm Rest Cover **M** to each Arm Rest **H**. Note where the holes are located on the armrests.  
Slide Shooting Rail Bracket **Z** onto each armrest. Attach Shooting Rail Knob **T** to Shooting Rail Bracket **Z**.

1. Attach Foot Platform **E** to the Top Ladder Section **A** using 1 - **M12x60mm bolt** on each side.

2. Attach Arm Rest Cover **M** to each Arm Rest **H**. Attach the front of Arm Rest **H** to Seat Platform **D** using 1 - **M10x50mm bolt** on each side.

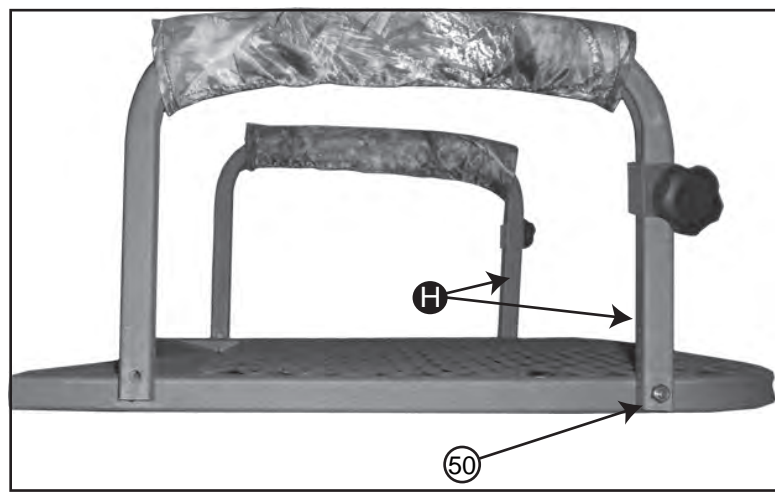

## You Will Need

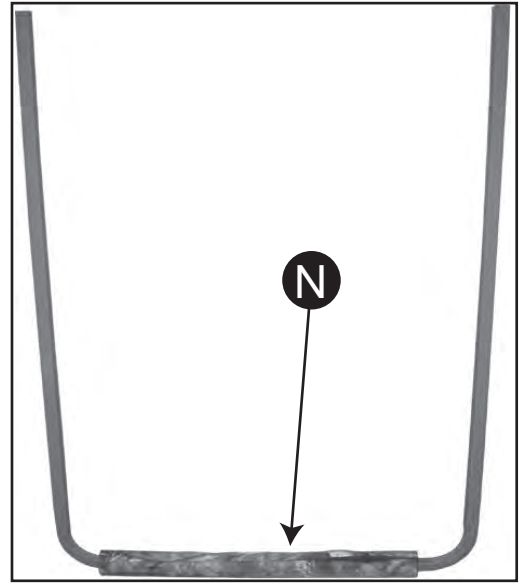
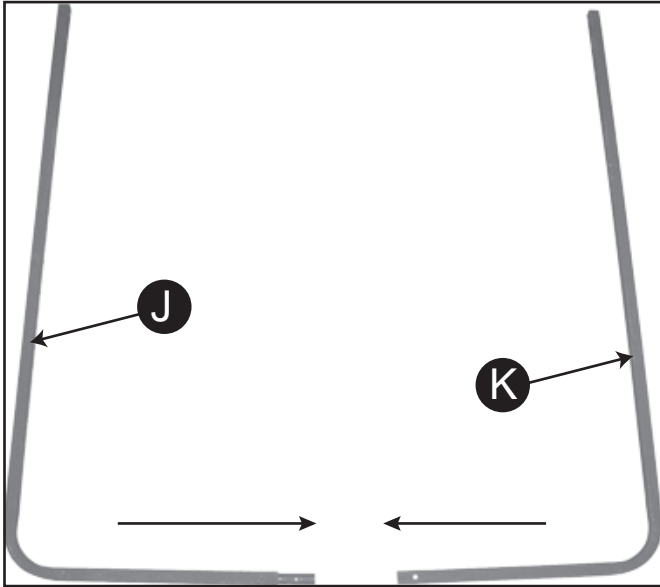
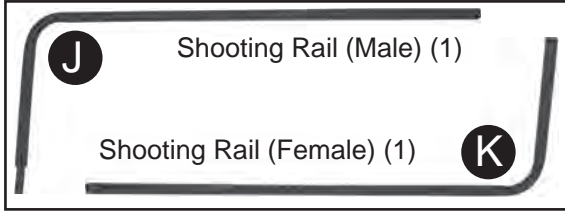

3. Slide both sections of the Shooting Rail together. Attach Shooting Rail Cover **N** to the Shooting Rail.

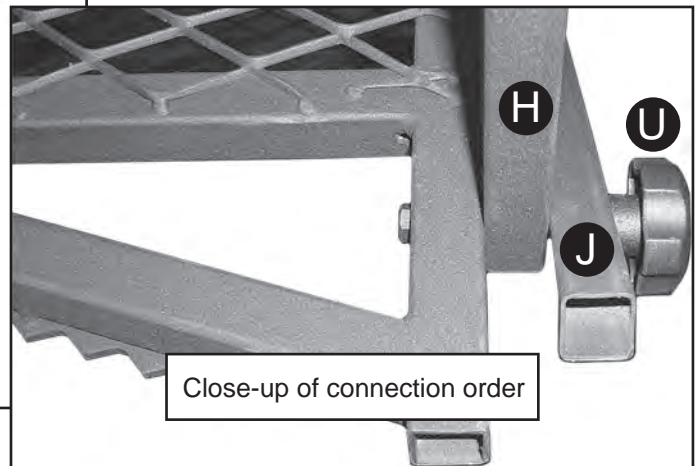
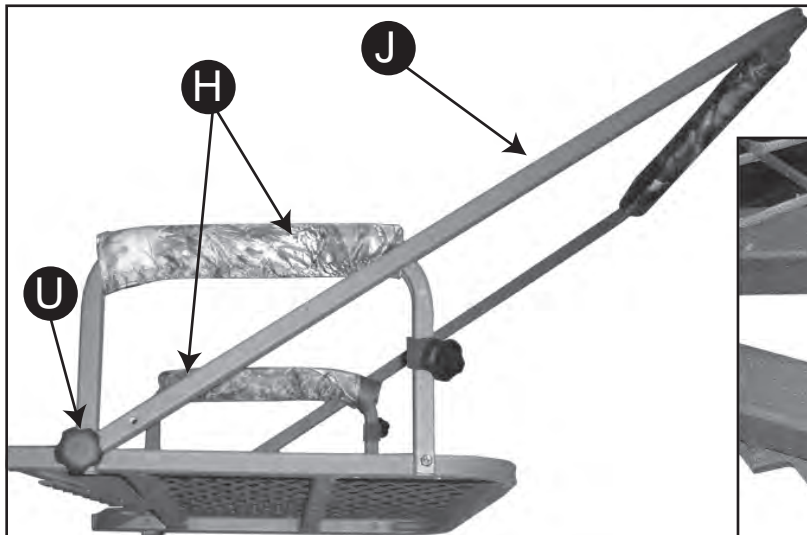

4. Attach the rear of Shooting Rail **J** to the rear of the Arm Rest **H** using Short Knob **U**. Insert the bolt through the seat platform, then through the Arm Rest and then through the Shooting Rail. Tighten the knob to secure the three parts together. Repeat for other side.

## You Will Need

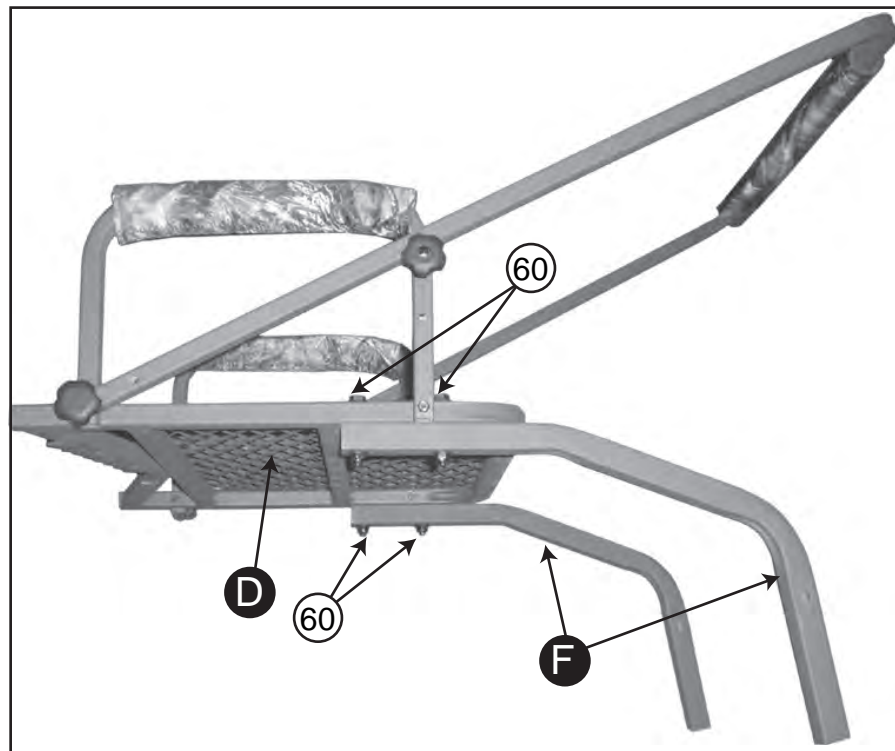
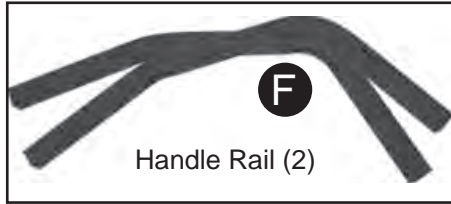

5. Attach Handle Rail **F** to the bottom of Seat Platform **D** using 2 - *M12x60mm bolts* on each side.



## You Will Need

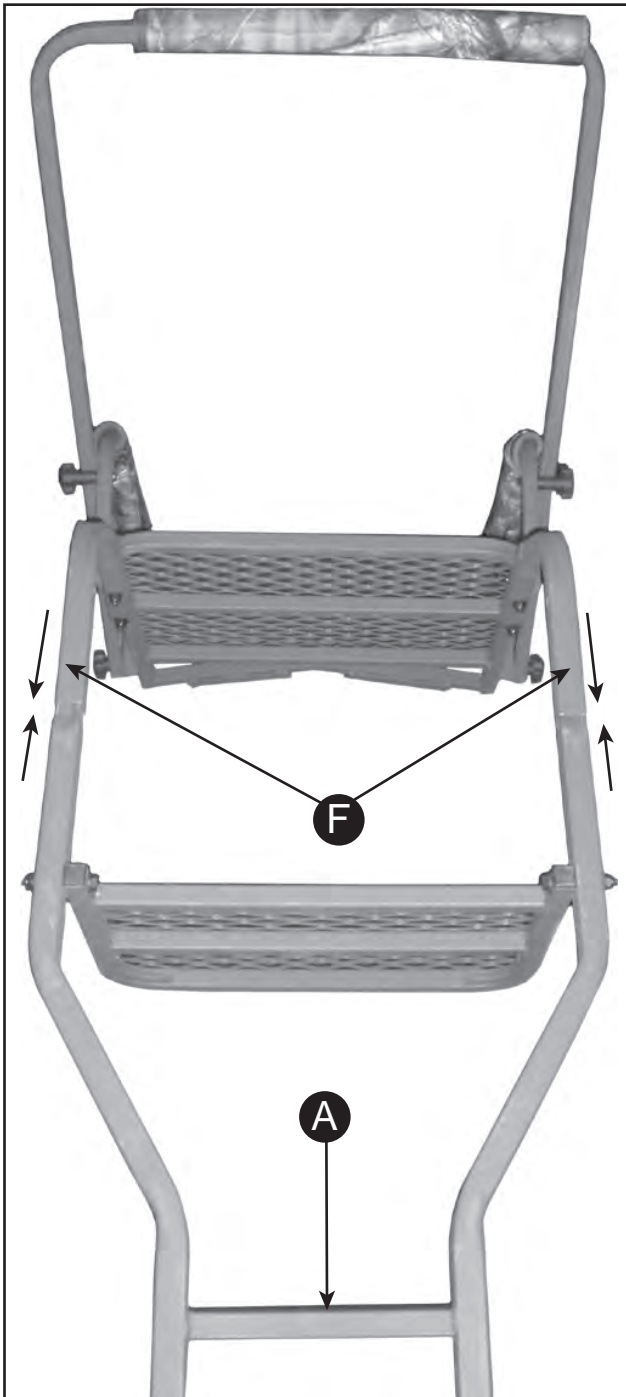
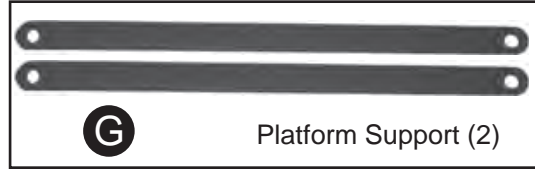

7. Slide the Top Ladder Section **A** into Handle Rails **F**.

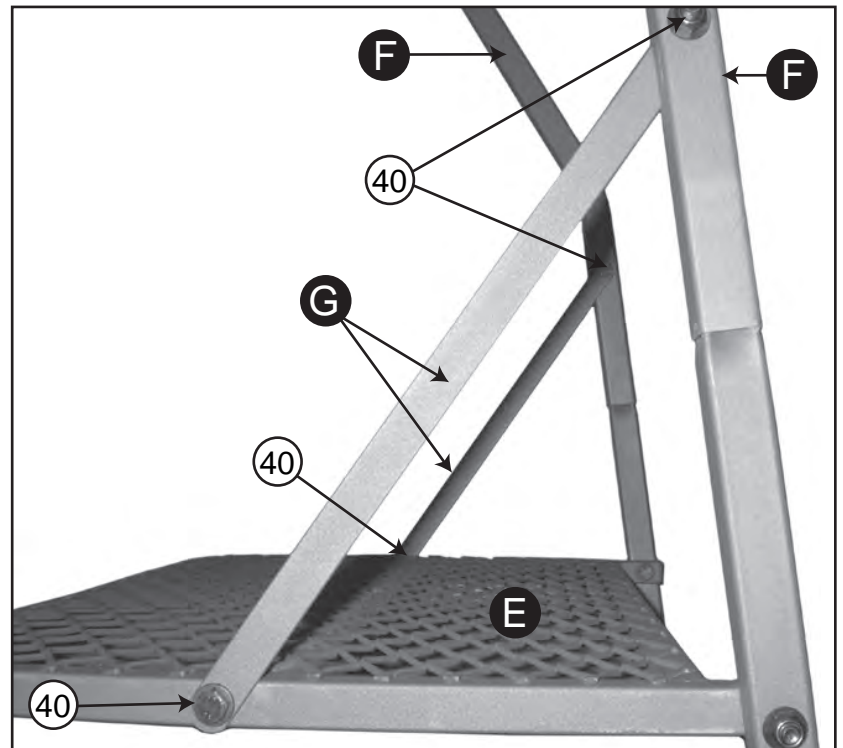

8. Attach one end of the Platform Support **G** to Foot Platform **E** using 1 - M12x40mm bolt for each side. Attach the other end of Platform Support **G** to the inside of Handle Rail **F** using 1 - M12x40mm bolt on each side.

## You Will Need

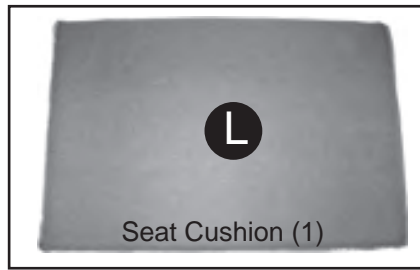

9. Attach Seat Cushion **L** to Seat Platform **D** by placing the cushion on top of the seat platform with the camo flap at the front of the platform.

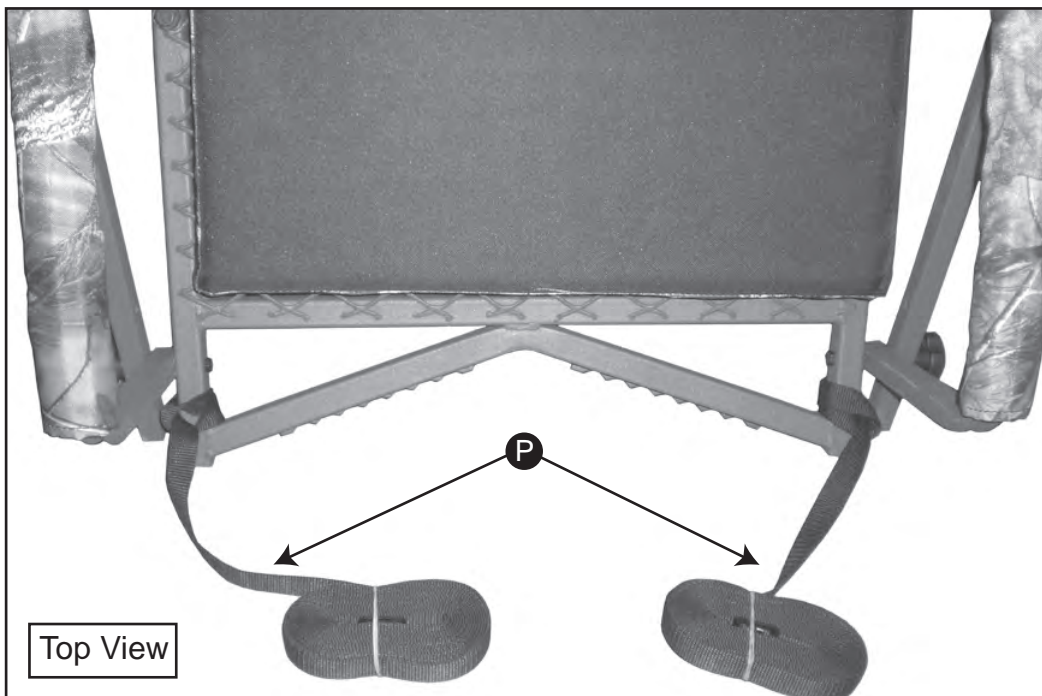

10. Attach Installation Cross Straps **P** to the rear of Seat Platform **D**. (See Installation Strap Instructions Page 1)

# Ladder Assembly Instructions

MODEL: 51007/9602A  
Gunner 16FT. Ladder Treestand

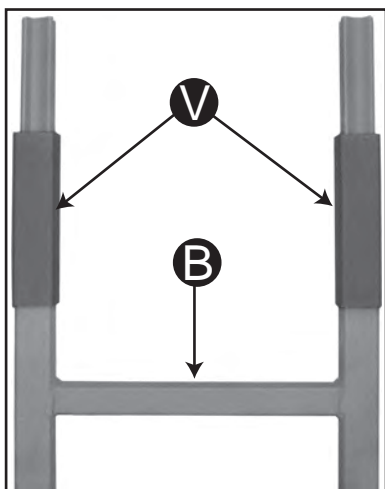

1. Slide Sleeves **V** over the crimps of Middle Ladder Section **B**.

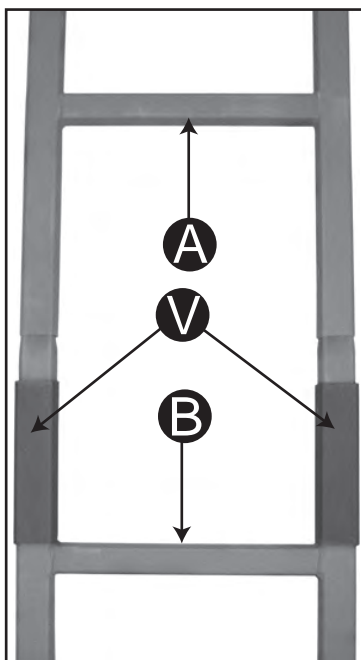

2. Insert Middle Ladder Section **B** into the Top Ladder Section **A**.



3. Slide the Sleeves over the joint where ladder sections are connected.

## NOTE

The Bracket on the Middle Ladder Section **MUST** be facing towards the tree.

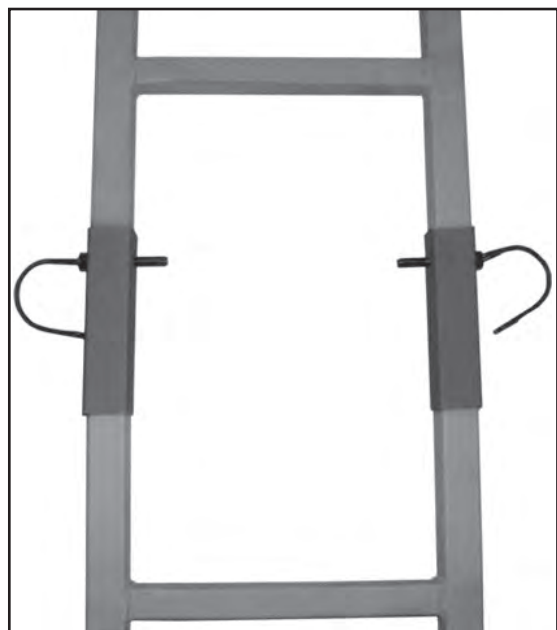

4. Insert 1 - **Quickclip** through the hole on the sleeve, and through the ladder sections on each side of the ladder.

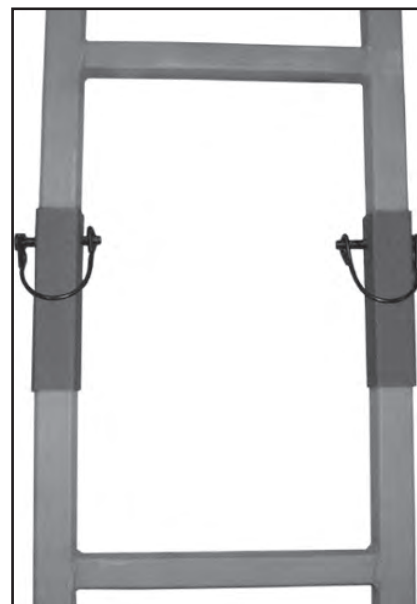

5. Close the quickclip to secure the ladder sections together.

6. Follow these above steps to attach the bottom section to the middle section.



1. Make sure Installation Straps **P** are secured on each side of the platform by following **Installation Strap Instructions Page 1**.

Remove the rubber band from around the straps. Let the straps hang loose.

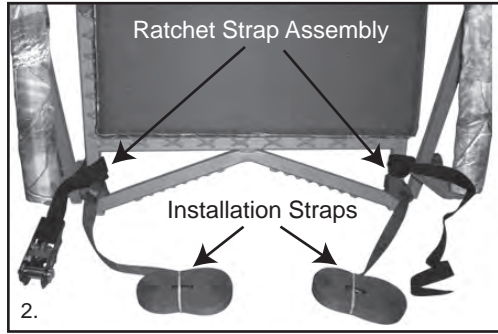

2. Attach Ratchet **R** to the outermost corners of the Handle Rail just behind the Installation Straps. (See Ratchet Strap Instructions.)

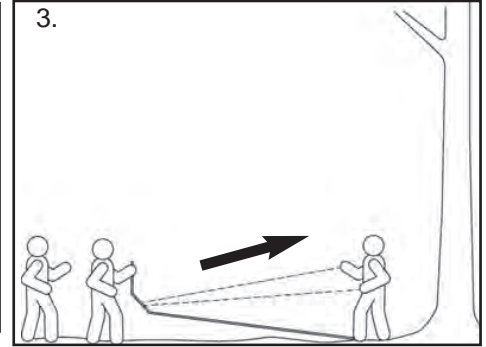

3. Position bottom of stand 4-5 feet from base of tree.

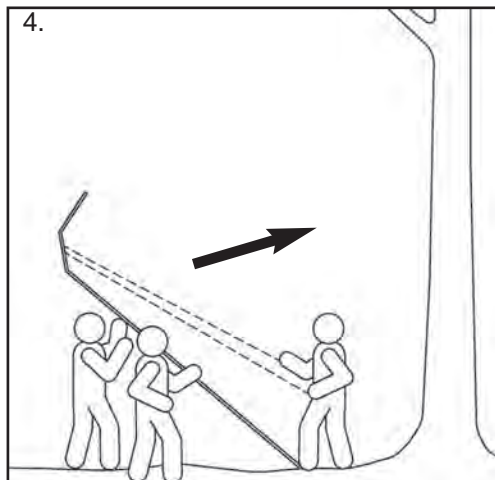

4. One person will stand at the base of ladder with his/her foot on bottom rung while holding installation straps. This will prevent tree stand from sliding. Two people will stand at opposite ends of tree stand, facing Platform and slowly walk tree stand upward using rungs of ladder.

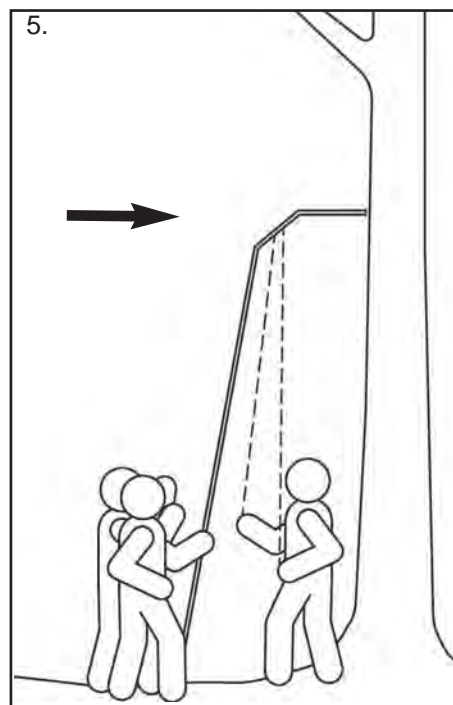

5. As tree stand is being raised, the person holding Installation Straps will pull toward themselves to take up slack. It will steady and ease the weight of stand on the other two people. Continue walking stand upward, until Tree Contact is resting against the tree.

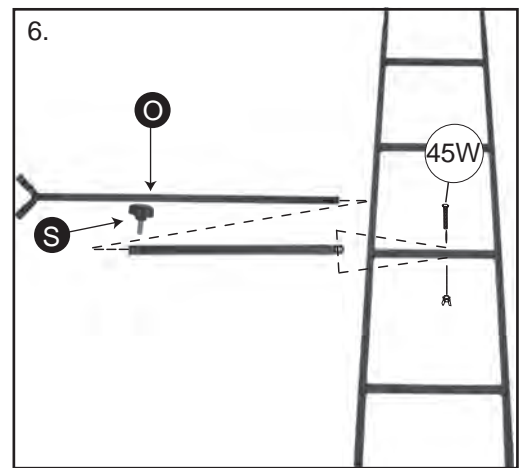

6. Slide the inner part of the Stabilizer Bar into the outer part. Attach Stabilizer Bar **O** to the second rung of the Middle Ladder Section with **1 - 12x45mm bolt and 1 wingnut**.

Insert the Adjustment Knob **S** in the Stabilizer bar at the proper adjustment point to the tree.

**⚠ WARNING**  
**DO NOT** climb ladder without stabilizer bar installed. Serious injury or death may occur if stabilizer bar is not installed.

**⚠ WARNING**  
Stabilizer Bar and Installation Straps **MUST** be secured prior to climbing the Ladderstand. Failure to comply may result in serious injury or death.

**NOTE:** Drawings are for illustration purposes only and may not depict actual product.

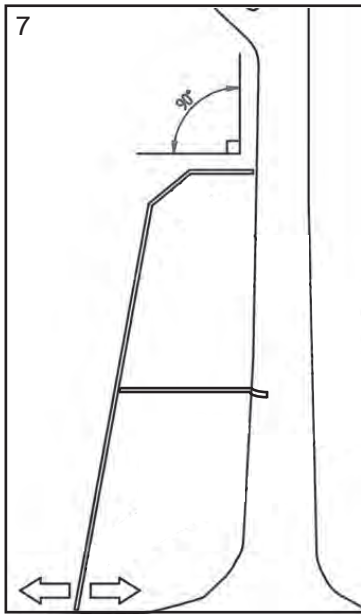

7. Move base of ladder toward or away from tree slightly in order to make Platform as parallel to the ground as possible.

Apply your full weight to the first step so it settles into the ground.

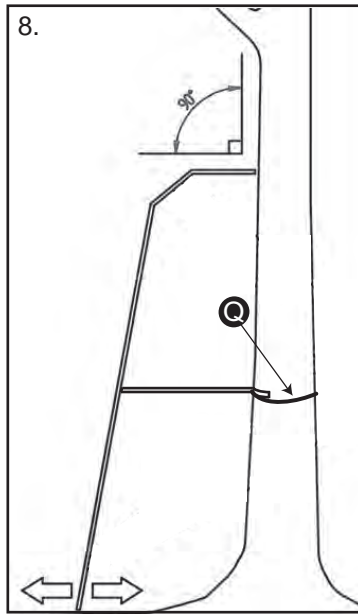

8. Tie one end of Tiedown Rope **Q** to the inner part of Stabilizer Bar near the flanged end. Wrap the rope around the back of the tree once. Then tie the other end of the rope to the stabilizer bar.

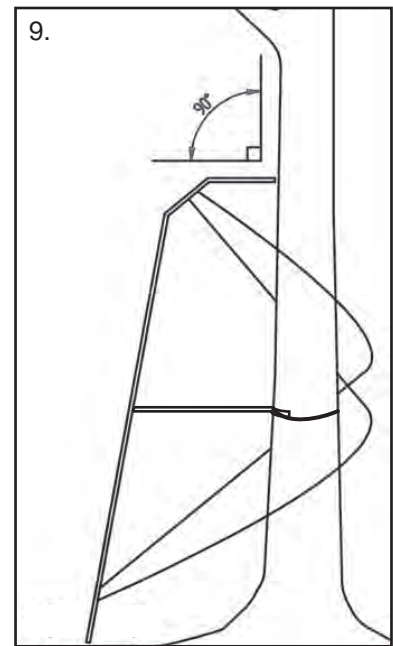

9. Cross Installation Straps behind tree. Attach to the bottom ladder section by following **Installation Strap Instructions Steps 4-8**.



10. After the ladder stand has been secured to the tree with the installation straps, and the stabilizer bar has been securely attached to the tree, continue to have two people hold the ladder, climb cautiously up to the platform. Once you reach the top, **IMMEDIATELY ATTACH YOUR SAFETY HARNESS TO THE TREE**. Keep the tether strap above your head.

11. Cautiously climb to the top of the treestand. Wrap the strap of the ratchet around the back of the tree and thread it through the ratchet. (See Detailed Ratchet Instructions Below).

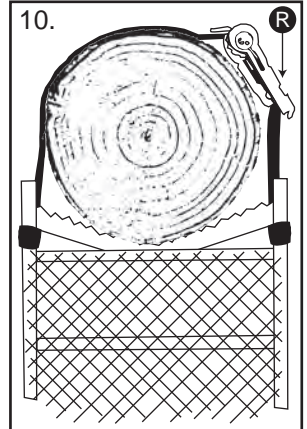

**⚠ WARNING**  
DO NOT climb ladder without stabilizer bar installed. Serious injury or death may occur if stabilizer bar is not installed.

**⚠ WARNING**  
Stabilizer Bar and Installation Straps **MUST** be secured prior to climbing the Ladderstand. Failure to comply may result in serious injury or death.

## Detailed Ratchet Strap Instructions

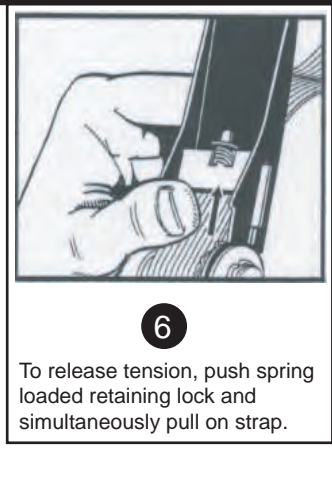
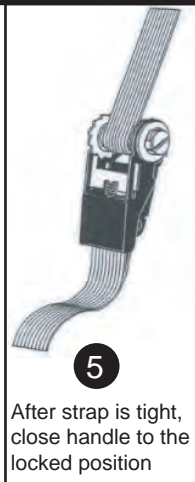
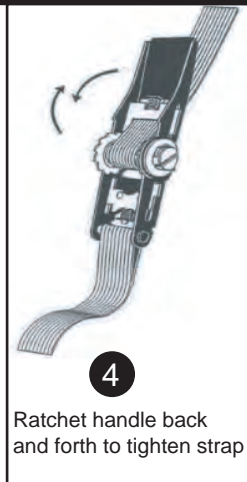
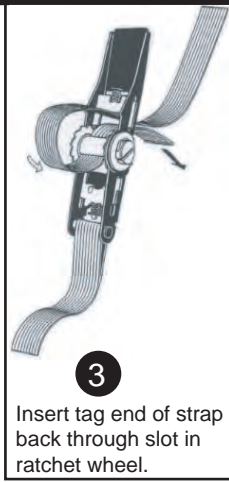
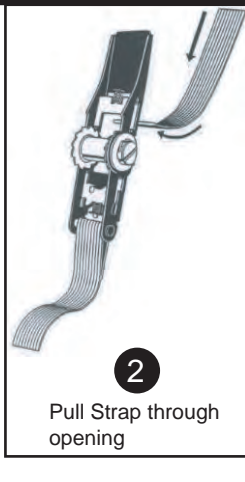
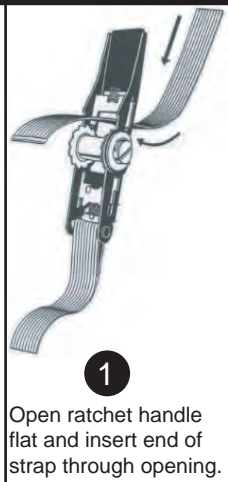

**⚠ WARNING** DO NOT sit on seat platform until the ratchet has been secured.

# Installation Strap Instructions



1. Place looped end of strap under platform.

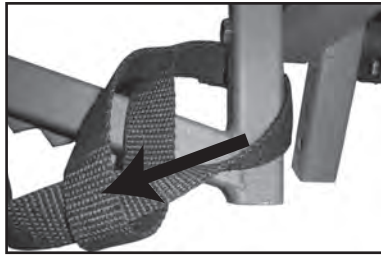

2. Insert loose end of strap through the loop.

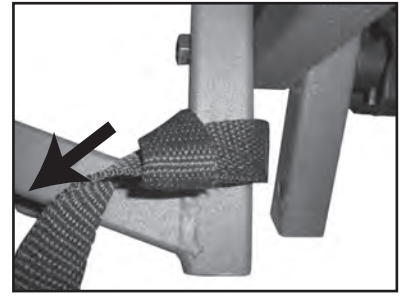

3. Pull to tighten. Continue with these steps to install the other strap on the other side of the platform.

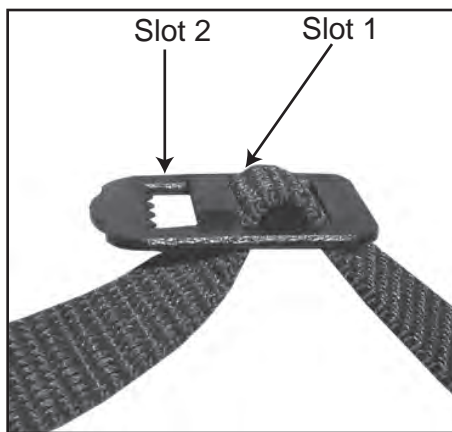

4. Place loose end of strap with clip, under the top rung of the bottom ladder section.



5. Insert the strap through Slot 1 on the clip.



6. Insert the strap through the Slot 2 with the teeth.

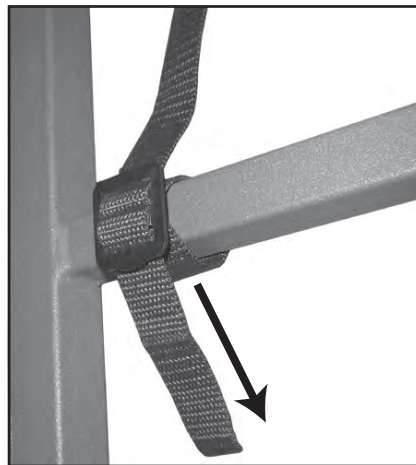

7. Pull strap to tighten.

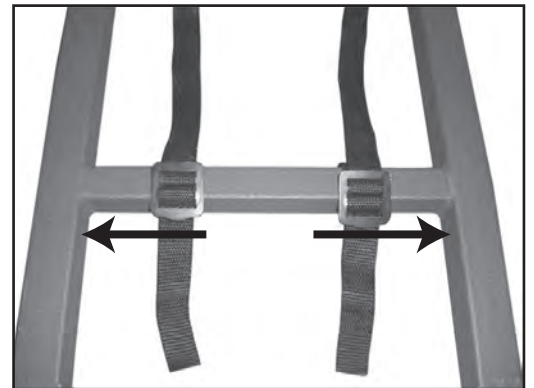

8. Slide the buckles out to the sides to create tension on the straps.

**⚠ WARNING** DO NOT sit on seat platform until the ratchet and installation straps have been secured.

# Ratchet Strap Instructions

You **MUST** follow these instructions prior to installation

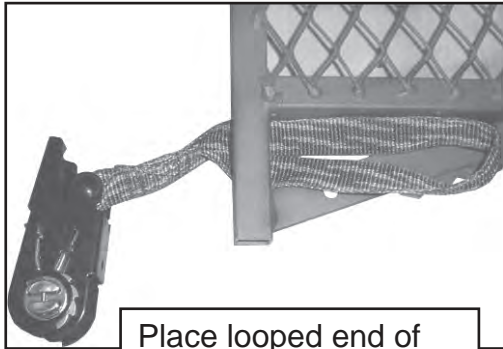

Place looped end of Ratchet under platform

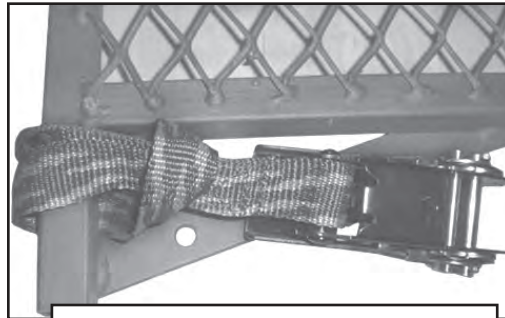

Insert ratchet through loop

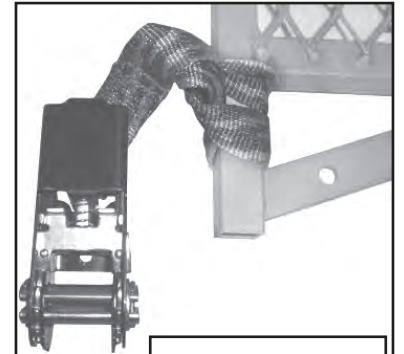

Pull to tighten

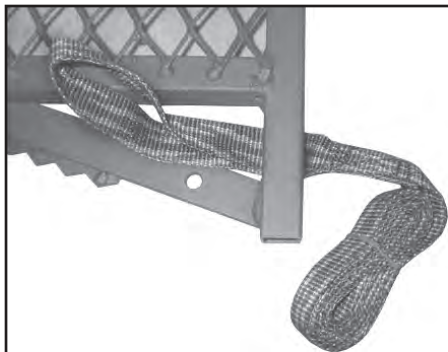

Place looped end of strap under platform

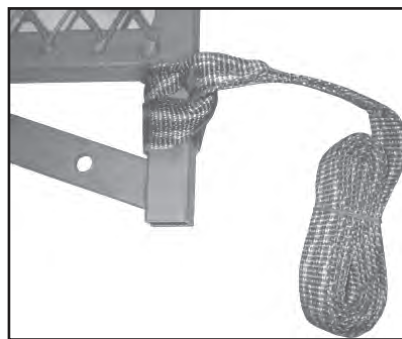

Insert strap through loop

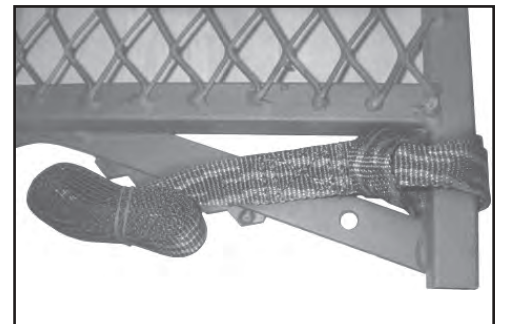

Pull to tighten

## Detailed Ratchet Strap Instructions

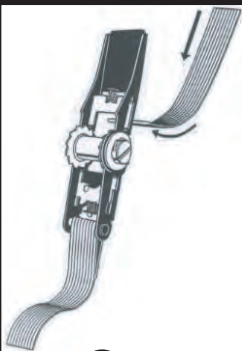

1

Open ratchet handle flat and insert end of strap through opening.

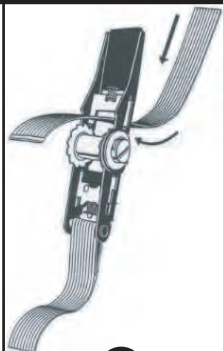

2

Pull Strap through opening

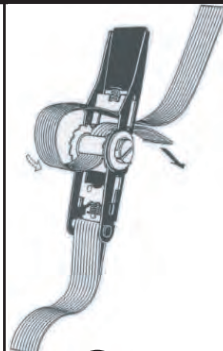

3

Insert end of strap through slot in ratchet wheel.

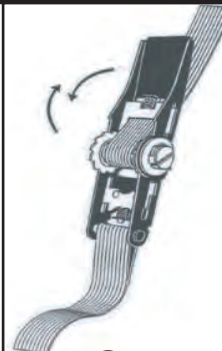

4

Ratchet handle back and forth to tighten strap

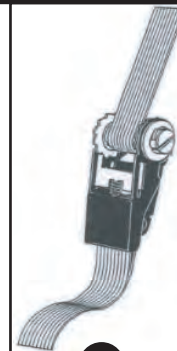

5

After strap is tight, close handle to the locked position



6

To release tension, push spring loaded retaining lock and simultaneously pull on strap.



# WARNING

Failure to follow all warnings listed below could result in serious injury or death.

**ALWAYS** read and understand all warnings and instructions before each use of this product. Failure to read and understand all warnings and instructions may result in serious injury or death.

**ALWAYS** inspect the tree stand for signs of wear or damage **BEFORE** each use. Also inspect to ensure that nuts and bolts are secure and straps are not frayed, worn, or broken.

**NEVER** exceed weight limit of **300 lbs.** **DO NOT** use if your combined weight with all your hunting gear and any accessories exceeds **300 lbs.** Use of tree stand over the weight limit may result in serious injury or death.

**ALWAYS** wear a Fall Arrest System (FAS) after leaving the ground. If you are not wearing an FAS that meets TMA standards, ***DO NOT leave the ground.*** Failure to wear an FAS may result in serious injury or death.

**DO NOT** use this tree stand while under the influence of alcohol, medication, or illegal substances. Use of tree stand while under the influence of any of these substances may result in serious injury or death.

**NEVER** use this tree stand if you have a history of health problems such as (*but not limited to*) heart problems, back problems, impaired vision, equilibrium impairments are afraid of heights or have been advised by a doctor not to do any strenuous activity. If you are feeling ill, nauseous, or dizzy **DO NOT** use this tree stand or If you are not physically fit, well rested and alert. Physical ailments can reduce your ability to safely install, utilize and remove your tree stand.

**NEVER** use this tree stand during inclement weather such as (*but not limited to*) thunderstorms, snowstorms, hurricanes, icy conditions, or high winds that could create slippery or dangerous situations.

**NEVER** use this tree stand on a dead, leaning, loose barked tree or on a utility pole as the tree may fall, break, or uproot and may result in serious injury or death.

**NEVER** leave the ground without checking every ladder section connection to ensure they are firmly connected. If ladder sections are separating, with the help of at least two other people, remove the tree stand from the tree, tighten all connections and reinstall on the tree.

**Installation Straps, Ratchet Straps, Quickclips, Tiedown Ropes and Stabilizer Bars MUST be installed and secured prior to climbing tree stand. Failure to comply may result in serious injury or death.**

**DO NOT** modify or alter your tree stand.

**NEVER** remove or deface warning labels.

Manufactured in the year 2011

Primal Vantage Company Inc. 685 Route 10 East, Randolph, NJ 07869 1-866-972-6168 Contact for replacement labels

Item #'s HEH00533 HEH00568 HEH00572 HEH00573

51007/9602, 51008/9601, 51036/9414, 51037, 51038