

MODEL: WMLS-510BC

15' TWO-MAN LADDERSTAND

- Always Wear a Safety Harness with this Product
- Practice Using at Ground Level
- Weight Limit: 500 lbs.
- Tree Size: 9"-18" diameter

Instruction and Safety Manual

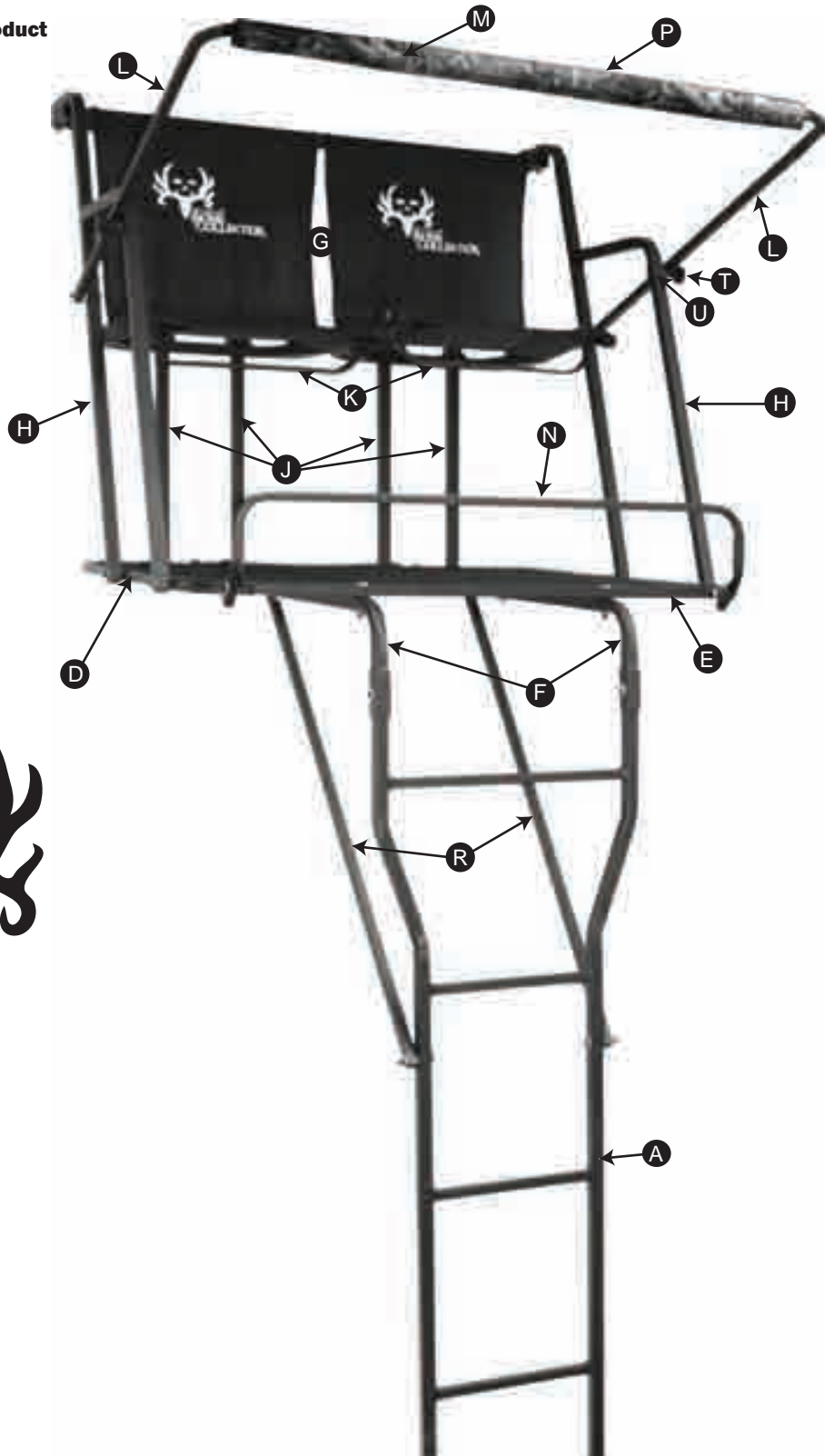

Warning

Every year serious injury and even death occurs from hunting related falls. To ensure your safety, please **COMPLETELY** read and follow this safety manual and ALL warning labels **BEFORE** assembling, installing or utilizing this product.

DO NOT USE THIS PRODUCT BEFORE FULLY UNDERSTANDING ALL SAFETY WARNINGS AND INSTRUCTIONS. IF YOU HAVE QUESTIONS, ARE UNSURE ABOUT ANY INFORMATION OR NEED ADDITIONAL INFORMATION CONCERNING YOUR PRODUCT, CONTACT OUR CUSTOMER SERVICE DEPARTMENT AT 1-866-972-6168 OR VISIT WWW.PRIMALVANTAGE.COM. KEEP AND MAINTAIN THIS SAFETY AND INSTRUCTION MANUAL IN A SAFE LOCATION FOR FUTURE REFERENCE.



PRIMAL
VANTAGE CO.

Distributed by Primal Vantage Company Inc. 685 Route 10 East, Randolph, NJ 07869

©2013 (rev. 02/13)

SAFETY MUST BE YOUR FIRST PRIORITY WITH THIS PRODUCT

TREESTAND SAFETY WARNINGS

Please read the following instruction manual and warnings labels completely before utilizing this product. Failure to understand and execute the instructions and warnings may result in serious injury or death. In the event of an accident, have a plan for rescue, including the use of devices that may be easily reached while suspended.

ALWAYS read and understand all warnings and instructions. Watch the enclosed DVD in its entirety before doing anything with this product including assembly, installation etc. before each use of this product. Failure to read and understand all warnings and instructions and DVD material may result in serious injury or death. Contact a Customer Service Representative with any questions you may have.

NEVER exceed total weight limit of **500 lbs.** **DO NOT** use if your combined weight with all of your hunting gear and any accessories exceeds **300 lbs.** or the combined weight of two people and equipment exceeds **500 lbs.** **DO NOT exceed the weight limit of the safety harness, refer to harness manufacturer's warnings for weight limit of safety harness.** Use of tree stand over the weight limit may result in serious injury or death.

DO NOT use this tree stand while under the influence of alcohol, medication or any illegal substances. Use of tree stand while under the influence of any of these substances may result in serious injury or death.

NEVER use this treestand during inclement weather. **DO NOT** use tree stand during thunderstorms, snowstorms, hurricanes, tornadoes or any other weather conditions that include (but not limited to) lightning, icy conditions, or high winds that could create slippery or dangerous situations. End your hunt and return to the ground if inclement weather conditions arise.

NEVER use treestand if you are feeling ill, nauseous, dizzy or if you have a prior condition that could cause a problem. i.e., heart condition, joints that lock-up spinal fusions, etc., or if you are not well rested and alert. Physical ailments can reduce your ability to safely install, utilize, and remove your treestand. Please consult a physician prior to use.

NEVER use this tree stand if you have a history of health problems such as (but not limited to) heart problems, back problems, high blood pressure, impaired vision, equilibrium impairments, are afraid of heights, have been advised by a doctor or physician not to climb. If you are not physically fit, well rested, and alert, or if you have any other physical or mental condition that would impair your ability to properly use this treestand.

NEVER use this tree stand on a tree that is dead, leaning, diseased, loose barked or on a utility pole as the tree may fall, break, or uproot and may result in serious injury or death. **NEVER** rely on a branch for support.

NEVER jump or bounce on the treestand's platform or ladder sections to seat it to the tree. Instead, step firmly on the first rung of the bottom ladder section to set the ladder into the ground before proceeding to climb the ladder.

NEVER transport any of your equipment with yourself while ascending or descending the tree. You will need to have two hands free during ascending and descending for safety. Use a haul line to pull up your firearm (unloaded, chamber opened with safety lock engaged, barrel facing towards the ground), bows, arrows, knives or any other equipment to your tree stand once you have reached your desired hunting height. **ONLY** pull up hunting equipment after the tree stand has been secured to the tree and after you and your harness have been secured to the tree. Prior to descending, lower your equipment on the opposite side of the tree from which you are climbing. Make sure that the unloaded firearm's safety lock is engaged and the gun barrel is pointing towards the ground.

ALWAYS hunt with a plan and a buddy. Before you leave home, let others know your exact location, when you plan to return and who is with you.

ALWAYS carry emergency signal devices such as a cell phone, walkie-talkie, whistle, signal flare, PLD (personal location device) and flashlight with you at all times and within reach even while you are suspended in your harness. Watch for changing weather conditions. In the event of an accident, remain calm and seek help immediately.

ALWAYS inspect the tree stand and the Fall Arrest System (FAS) (Harness) for signs of wear or damage **BEFORE** each use. Also inspect to ensure that nuts and bolts are secure. Pay special attention to the harness and straps, guaranteeing that nothing has been frayed or severed. Destroy all products that cannot be repaired by the manufacturer. Contact a Customer Service Representative for replacement parts. The Fall Arrest System **MUST** be discarded and replaced after a fall has occurred.

DO NOT ATTACH YOUR FULL BODY HARNESS TO YOUR TREESTAND.

NEVER modify your treestand in any way by making repairs, replacing parts, or altering adding or attaching anything to it except if explicitly authorized in writing by the manufacturer. Improper installation or adjustment may cause serious injury or death. Remove all contents from box. Inspect for any damaged or missing parts. If any parts are missing or damaged, you must only use certified replacement parts. Using any other replacement parts will void product warranty. **THERE ARE NO EXTRA PARTS.** All parts **MUST** be used to ensure the safety of you and your stand. If you think parts are missing or damaged, **STOP IMMEDIATELY** and contact our Customer Service Department. Using the tree stand with missing or damaged parts may result in serious injury or death. **DO NOT** return this product to the retailer. Contact a Customer Service Representative if you have any missing, damaged or extra parts.

ALWAYS keep instructions (written and video) in a safe place and review before each use. It is the responsibility of the treestand owner to furnish the complete instructions to anyone who borrows or purchases the treestand from you. A safe treestand hunting video has been included. Please view it in its entirety prior to using this product.

NEVER use this treestand for any use other than hunting. Our treestands are designed for hunter's to wear a Full Body Harness. If you are not completely comfortable and confident with your ability to safely install, ascend, hunt and descend using a Full Body Safety Harness with this treestand, **DO NOT PROCEED.**

NEVER use this treestand for trimming trees.

NEVER fall asleep in your stand as you may fall out resulting in serious injury or death.

ALWAYS be sure to check and retighten any bolts **BEFORE** each new use of treestand.

ALWAYS have a minimum of three people present when installing or removing this treestand.



©2013 (rev. 06/12)

CHOOSING A SAFE TREE

- **ALWAYS** thoroughly inspect the tree before installing your product. **DO NOT** install your **TREE/LADDER STAND** onto any dead or unsafe tree, telephone or utility pole, structural column, or man-made structure. Doing so may result in serious injury or death.
- **ALWAYS** select the proper tree for use with your **TREE/LADDER STAND**. Select a live straight tree that fits within size limits recommended (minimum tree diameter must be no less than 9 inches and maximum of 18 inches.). **DO NOT** rely on a branch for support.
- **DO NOT** select a tree in the dark or choose a tree in close proximity to a fence. You must not have any stumps or rocks beneath your tree.
- **NEVER** use **TREE/LADDER STAND** on a tree that is dead, diseased, leaning or on wet and uneven ground as the tree may fall, break or uproot.
- Your tree must not be wet, icy or slippery or on wet, swampy, or loose ground that allows the tree to be unstable. Check the ground under **TREE/LADDER STAND** to ensure it is firm and level.
- Be sure you have a level stand platform. Your tree must not lean or have any irregular shape.
- Tree must not have any loose or scaly bark or excessive vines, nails, screws, or any other sharp objects protruding that may sever webbing on product. Any surrounding trees must not lean or have dead limbs that may fall onto you or your product.
- **NEVER HURRY!! HURRYING CAUSES ACCIDENTS!!** While climbing a **TREE/LADDER STAND**, make slow, even movements no more than ten to twelve inches at a time. Make sure you have proper contact with tree and/or **TREE/LADDER STAND** every time you move. On ladder tree stand, **ALWAYS** maintain three points of contact with each step and **ALWAYS** lean forward as you climb.

Several treestands are equipped with a footrest, armrests and/or shooting rail. Neither the footrest, armrests nor the shooting rail have been designed to support a user's weight. Under **NO** circumstances should you place more than fifteen (15) pounds of weight on these structures. Doing so will put the user in serious risk of injury or death.

PROPER CARE AND MAINTENANCE:

- Inspect for defects (damage, rot, corrosion, cracks, freezing, excessive heat, etc.) before every use is required. Do not use if damage is detected or suspected.
- We recommend replacing all hardware/cables/nuts/bolts/clips on your tree stand every two (2) years or sooner if inspection finds it necessary. Use only Primal Vantage approved replacement straps and parts. Use of any other straps or parts, will be viewed as a modification to the product. Any modification will void the warranties and relieve Primal Vantage from all liabilities. Failure to follow these instructions may result in serious injury or death.
- **DO NOT** overtighten the hardware. **DO NOT** use a socket wrench. This can lead to structural damage and may negatively affect the performance of your stand. Failure to follow these instructions may result in serious injury or death.
- All photos are taken from the front view unless otherwise noted.
- By registering your product, you may be enrolled in our discount program.
You may receive a 20% off coupon for our website store, www.primal-store.com to purchase replacement parts in the future.
- In most cases, bolts come with two nylon washers. One washer will be placed against the bolt head the other washer will be placed against the nut.



MODEL: WMLS-510BC

15' TWO-MAN LADDERSTAND

- Always Wear a Safety Harness with this Product
- Practice Using at Ground Level
- Weight Limit: 500 lbs.
- Tree Size: 9"-18" diameter

Michael Woodall's
BONE COLLECTOR™



PARTS LIST

- A** 1 Top Ladder Section.....Part # WSL-5300s
- B** 1 Middle Ladder Section.....Part # WSL-5310s
- C** 1 Bottom Ladder Section.....Part # WSL-5320s
- D** 1 Rear Platform.....Part # WRP-510
- E** 1 Front Platform.....Part # WFP-510
- F** 2 Handle Rail.....Part # WHR-510
- G** 1 Seat Assembly (Pre-Assembled)
2 Seat Support.....Part # WSP-510
1 Back Brace.....Part # WBB-510
2 Seat Fabric.....Part # WSC-510
- H** 2 H-Frame.....Part # WHF-510
- J** 4 Rear Brace.....Part # WRB-510
- K** 2 Spreader Bar.....Part # WSB-510
- L** 1 Shooting Rail Extender.....Part # WSX-510
- M** 1 Shooting Rail.....Part # WSR-510
- N** 1 Footrest.....Part # WFR-510
- O** 1 Tree Connection Brace.....Part # WTB-510
- P** 1 Shooting Rail Cover.....Part # PSC-500
- R** 2 Platform Brace.....Part # WPB-510
- S** 1 Stabilizer Bar.....Part # WSB-200
- T** 2 Shooting Rail Knob.....Part # SRK-100
- U** 2 Shooting Rail Bracket.....Part # SRB-510
- V** 1 Adjustment Knob.....Part # AK-100
- W** 2 Installation Strap.....Part # ICS-1000
- X** 2 Ratchet Strap.....Part # RA-100
- Z** 1 Tiedown Rope.....Part # TR-1000

HARDWARE

- 65** 6 M12x65mm Bolt.....Part # 1265
- 65w** 2 M12x65mm Bolt w/wingnut.....Part # 1265w
- 60** 20 M12x60mm Bolt.....Part # 1260
- 58** 2 M12x55mm Bolt w/3 washers.....Part # 1258
- 55** 3 M12x55mm Bolt.....Part # 1255
- 50** 4 M12x50mm Bolt w/4 washers.....Part # 1254
- 45w** 1 M12x45mm w/wingnut.....Part # 1245w
- 60** 2 M10x60mm Bolt w/ bushing.....Part # 1060b
- 50** 4 M10x50mm Bolt.....Part # 1050
- 40** 2 M10x40mm Bolt.....Part # 1040
- 25** 2 M10x25mm Bolt.....Part # 1025
- 2 Harness.....Part # 2013

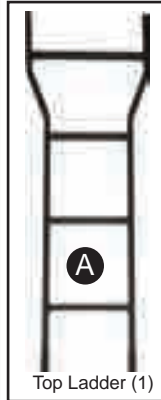

Top Ladder (1)



Middle Ladder (1)

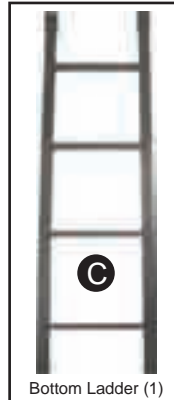

Bottom Ladder (1)

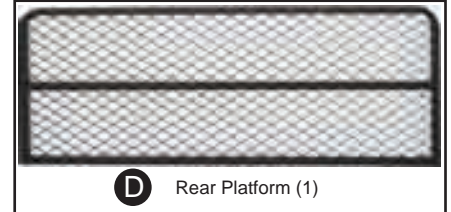

Rear Platform (1)

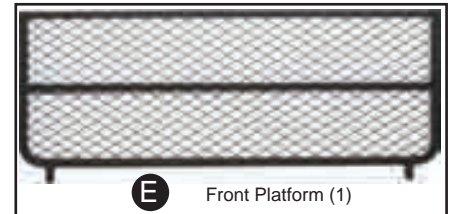

Front Platform (1)



Handle Rail (2)

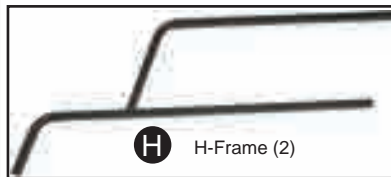

H-Frame (2)

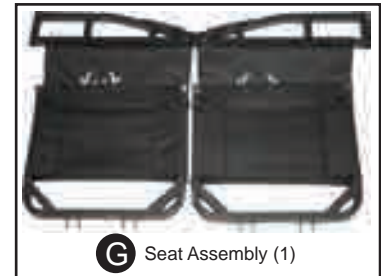

Seat Assembly (1)



Rear Brace (4)

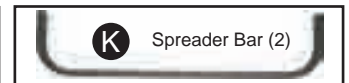

Spreader Bar (2)



Shooting Rail Extender (2)

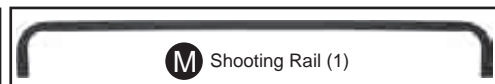

Shooting Rail (1)



Footrest (1)



Tree Connection Brace (1)



Shooting Rail Cover (1)



Platform Brace (2)

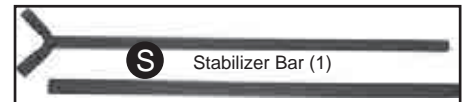

Stabilizer Bar (1)



Shooting Rail Knob (2)
(Found in Blister Pack)

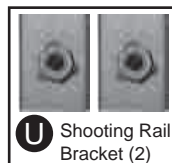

Shooting Rail Bracket (2)



Adjustment Knob (1)
(Found in Blister Pack)



Installation Strap (2)

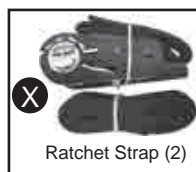

Ratchet Strap (2)



Tiedown Rope (1)

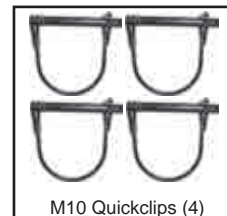

M10 Quickclips (4)



Tools Required
Adjustable Wrench



PRIMAL
VANTAGE CO.

Distributed by Primal Vantage Company Inc. 685 Route 10 East, Randolph, NJ 07869

©2013 (Rev. 02/12)

CUSTOMER SERVICE DEPARTMENT 1-866-972-6168

WWW.PRIMALVANTAGE.COM

ALL PHOTOS TAKEN FROM FRONT VIEW UNLESS OTHERWISE NOTED

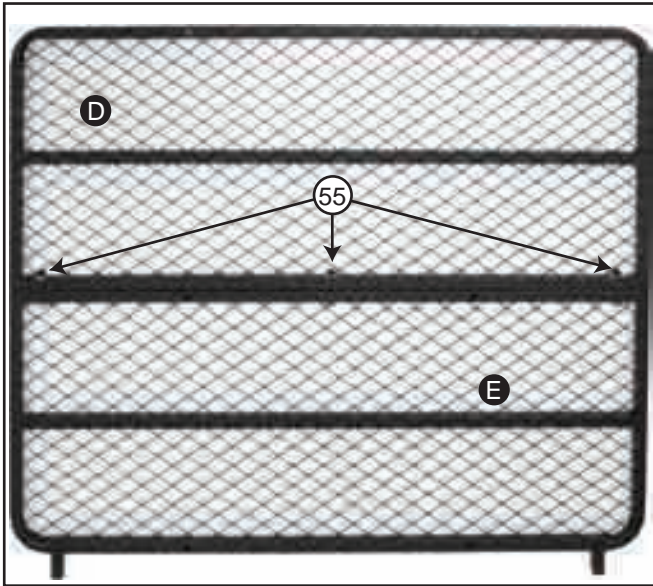

1. Attach Front Platform **E** to Rear Platform **D** using **3-M12x55mm Bolts. (3 Total)**

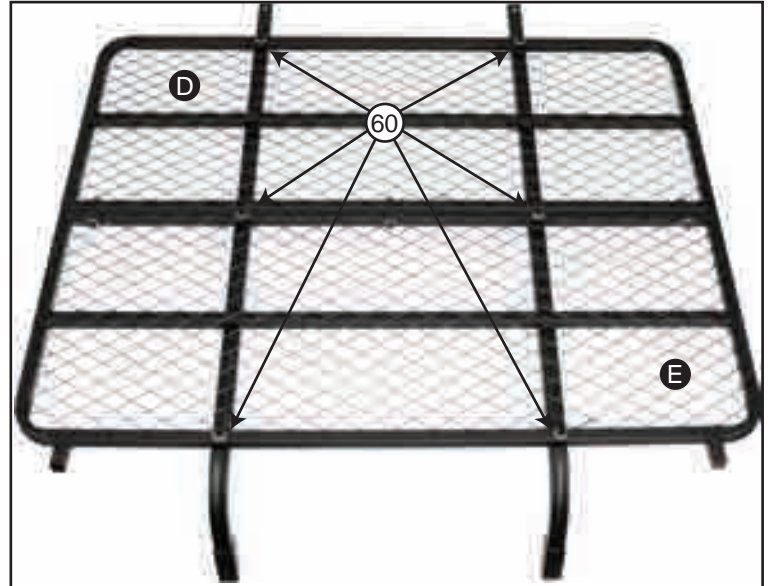

2. Attach Handle Rails **F** to the **BOTTOM** of the assembled platforms using **3-M12x60mm Bolts. (6 Total)**

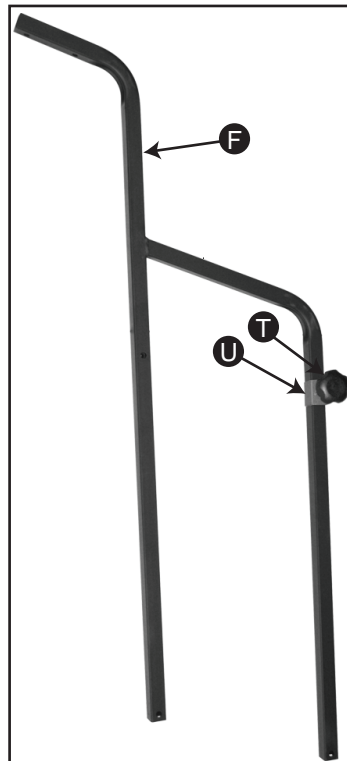
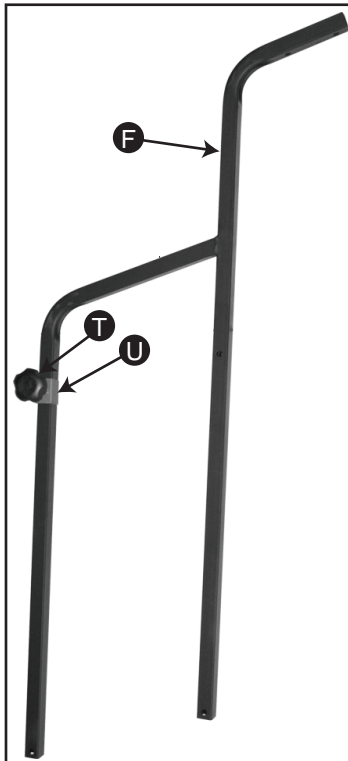

3. Slide Shooting Rail Bracket **U** onto front bar of H-Frame **H**. Insert Shooting Rail Knob into Shooting Rail Bracket.

The Shooting Rail Knobs need to be attached so they are facing away from each other.



PRIMAL
VANTAGE CO.

Distributed by Primal Vantage Company Inc. 685 Route 10 East, Randolph, NJ 07869

CUSTOMER SERVICE DEPARTMENT 1-866-972-6168

©2013 (rev. 02/12)

WWW.PRIMALVANTAGE.COM

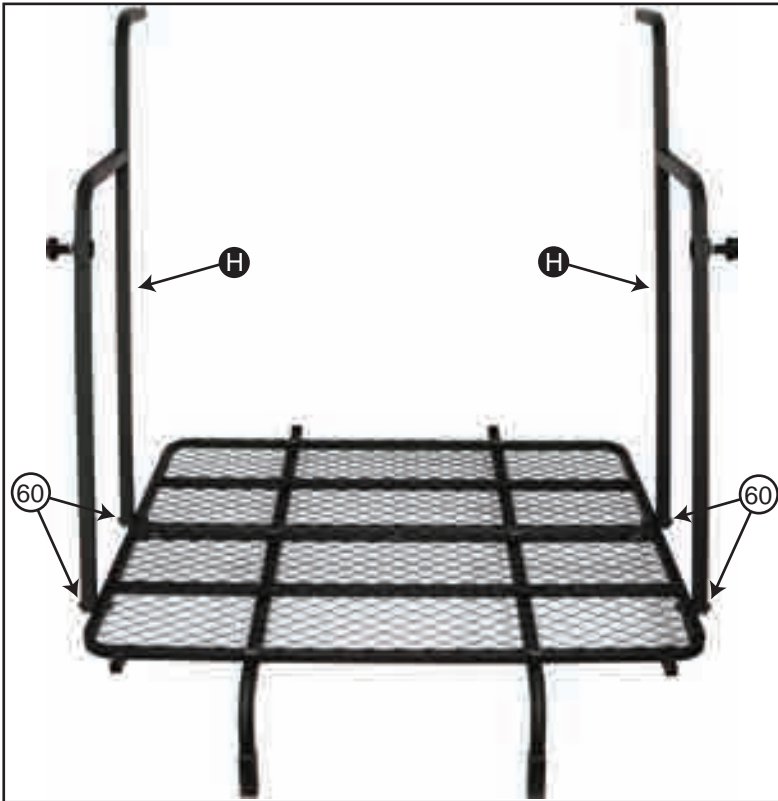

4. Attach H-Frames **H** to Front Platform **E** and Rear Platform **D** using **2-M12x60mm Bolts** on each side. **(4 Total)**



5. Attach Seat Assembly **G** to the **BOTTOM** of each Handle Rail **H** using **2-M12x65mm Bolts** on each side. **(4 Total)**

NOTE: The teeth on the Back Brace will need to be facing up.



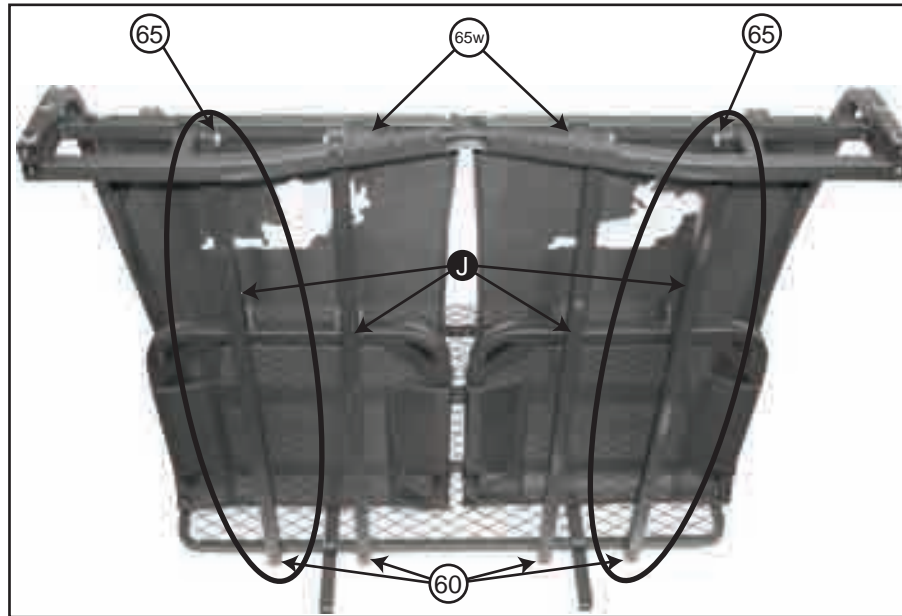

6. Attach the circled Rear Braces **J** to rear of Seat Assembly **G** using **1-M12x65mm Bolts** first. Then attach to Rear Platform **D** using **2-M12x60mm Bolts**.

Attach the remaining Rear Braces **J** to the rear of Seat Assembly **G** using **1-M12x65mm Bolt with wingnuts**. Then attach to Rear Platform **D** using **1-M12x60mm Bolts**.

NOTE: The tops of the Rear Braces will be on the **INSIDE** of the small tubes welded to the Back Brace.

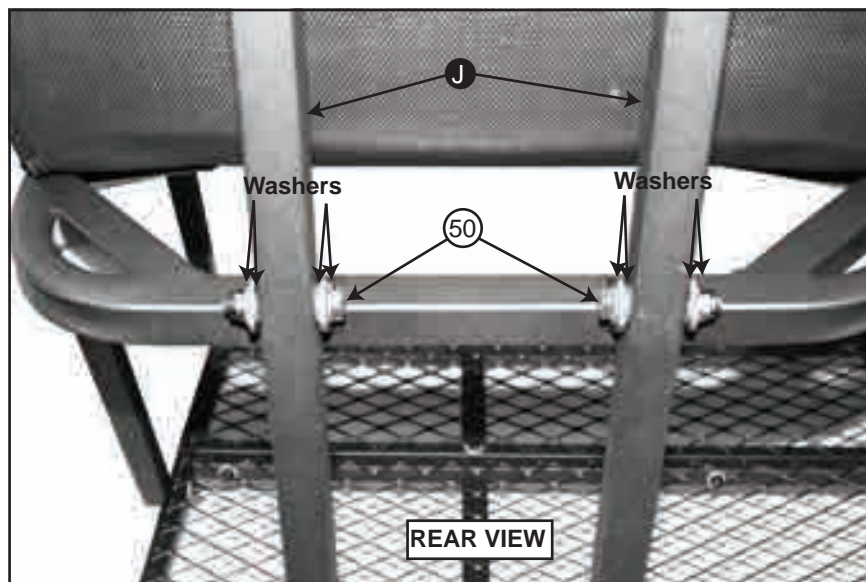

7. Line up the brackets on the Seat Frame to the hole in the center of Rear Brace **J**. Insert **1-M12x50mm Bolt with 4 washers** through the Rear Brace and the brackets. A washer will need to be placed between each component so there is no metal to metal contact.



PRIMAL
VANTAGE CO.

Distributed by Primal Vantage Company Inc. 685 Route 10 East, Randolph, NJ 07869

©2013 (rev. 02/12)



8. Attach Tree Connection Brace **C** to the top of Handle Rails **F** using **1-M12x60mm Bolt** on each side. **(2 Total)**



9. Attach Spreader Bar **K** to underside of Seat Frame using **2-M10x50mm Bolts** for each seat. **(4 Total)**



PRIMAL
VANTAGE CO.

Distributed by Primal Vantage Company Inc. 685 Route 10 East, Randolph, NJ 07869

©2013 (rev. 02/12)

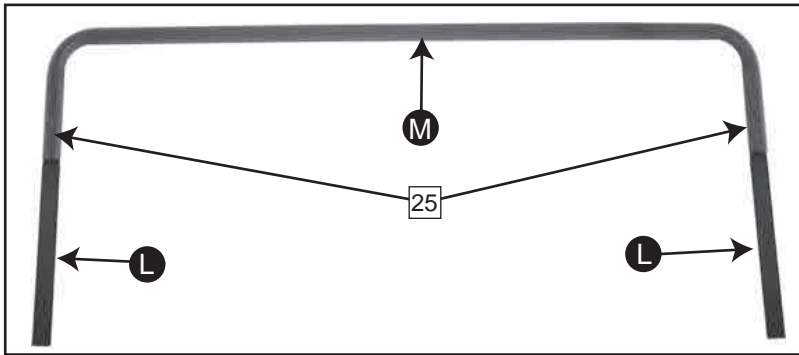

10. Insert each Shooting Rail Extender **L** into Shooting Rail **M** and secure with **1-M10x25mm bolt** on each side.



11. Attach assembled Shooting Rail to rear of H-Frame **H** using **2-M10x60mm Bolts with Bushings**. The Shooting Rail will rest on top of the Shooting Rail Knobs. (See Closeup Below)

NOTE: The Bushings will be placed between the H-Frame and the Shooting Rail.

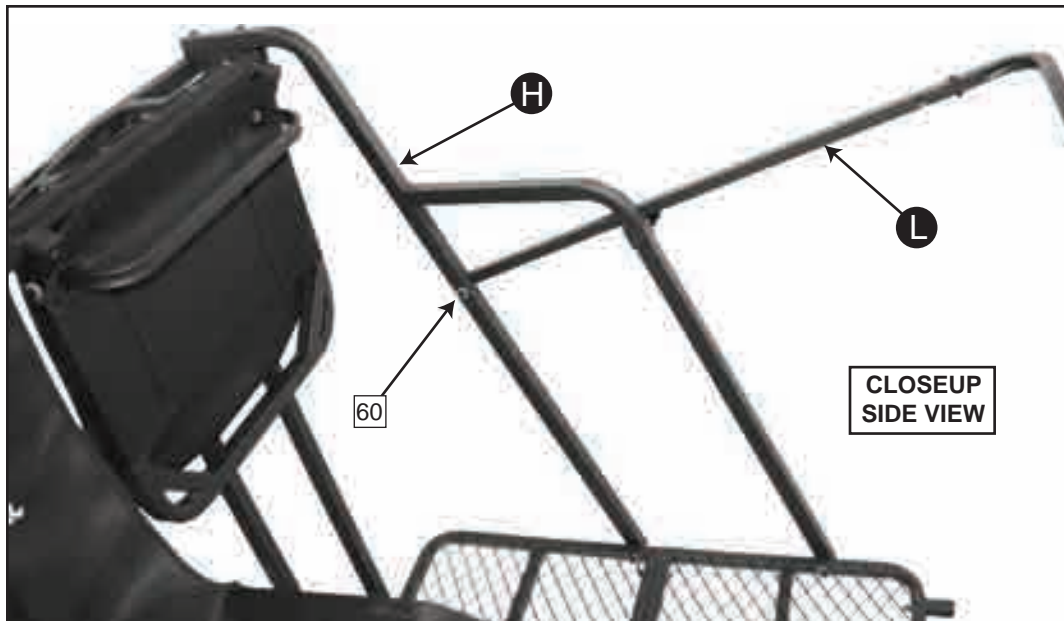

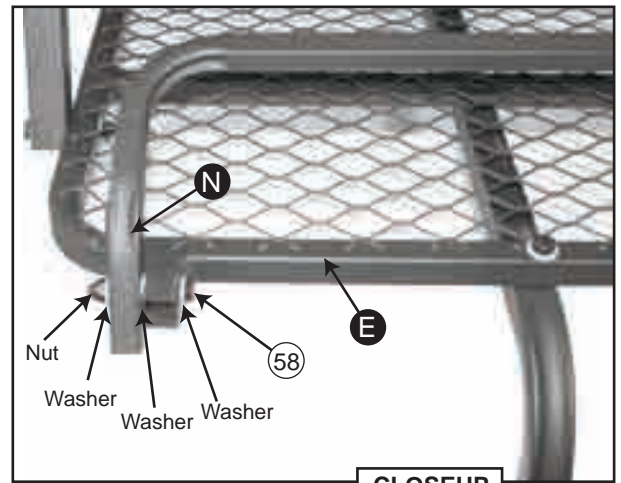
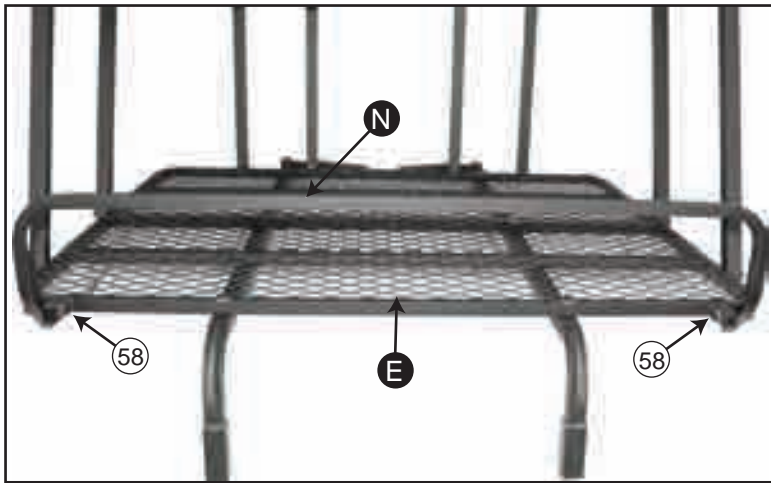

CLOSEUP

12. Attach Footrest **N** to Front Platform **E** using **2-M12x55mm Bolts with 3 washers.** (See Closeup)

13. Attach Shooting Rail Cover **P** to Shooting Rail **M**.

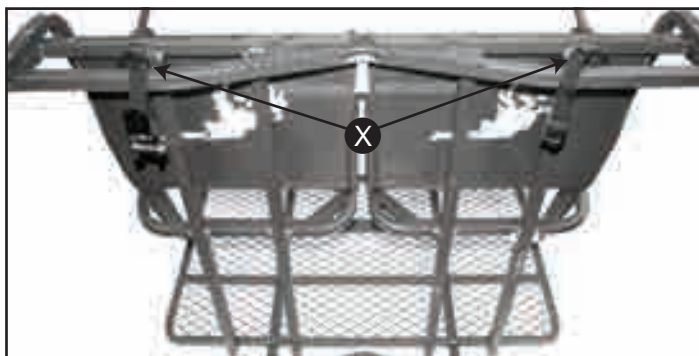

14. Attach Ratchet Strap **X** to rear of Seat Assembly. (See Ratchet Strap Instructions)

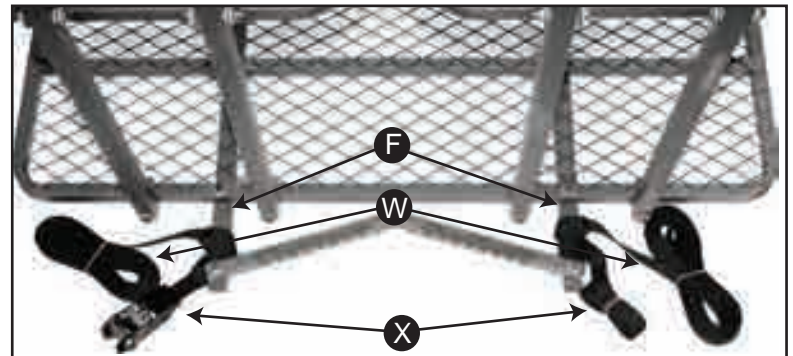

15. Attach remaining Ratchet Strap **X** to Handle Rail **F** between Rear Platform and Tree Connection Brace. (See Ratchet Strap Instructions)

Attach Installation Cross Straps **W** just behind the attached Ratchet Straps between Rear Platform and Tree Connection Brace. (See Installation Strap Instructions)



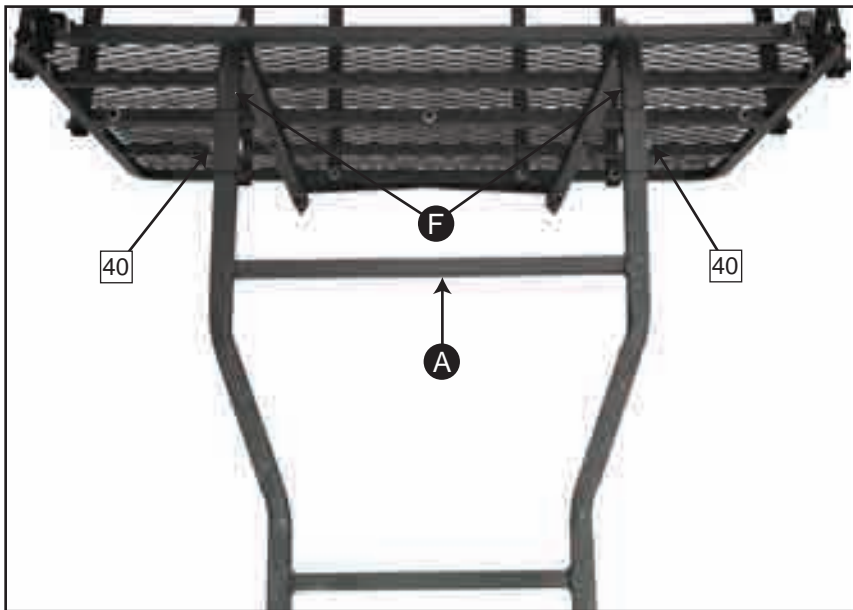

16. Insert Top Ladder Section **A** into Handle Rails **F**. Use **2-M10x40mm Bolts** to secure.

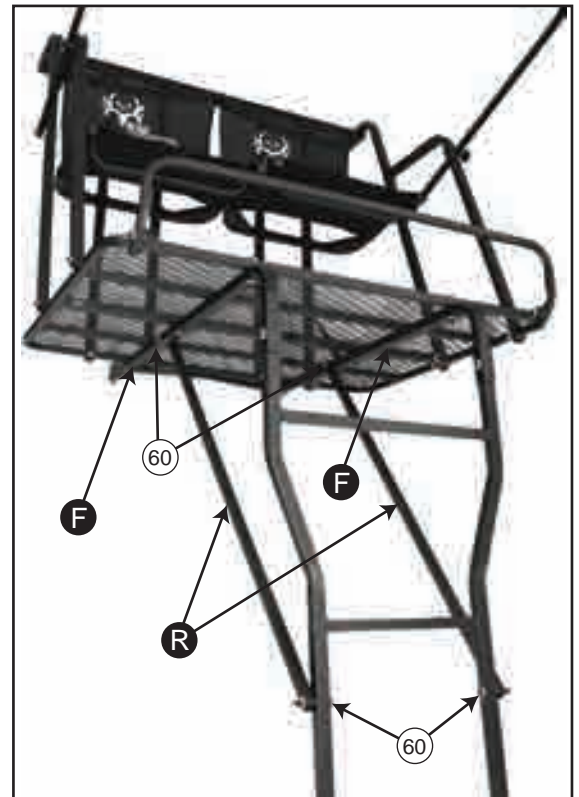

17. Attach one end of Platform Brace **R** to the **INSIDE** of Handle Rail **F** underneath the platform using **1-M12x60mm Bolt** on each side.

Attach the opposite end of Platform Brace **R** to the **OUTSIDE** of Top Ladder Section **A** using **1-M12x60mm Bolt** on each side.



18. Slide Sleeved end of Ladder Section **A** over Ladder Section **B**.



19. Insert **1 - Quickclip** through the hole on the sleeve, and through the ladder sections on each side of the ladder.



20. Close the quickclip to secure the ladder sections together.

21. Follow **Steps 18-20** to attach the bottom section to the middle section.



PRIMAL
VANTAGE CO.

Distributed by Primal Vantage Company Inc. 685 Route 10 East, Randolph, NJ 07869

CUSTOMER SERVICE DEPARTMENT 1-866-972-6168

©2013 (rev. 03/12)

WWW.PRIMALVANTAGE.COM

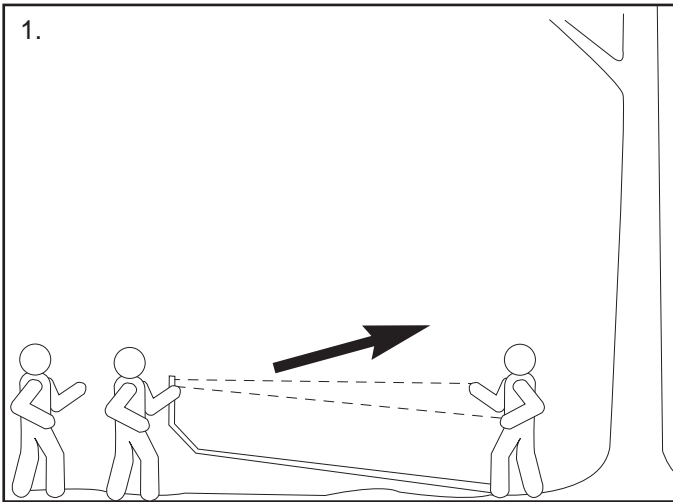

1. Position bottom of stand 4-5 feet from base of tree.

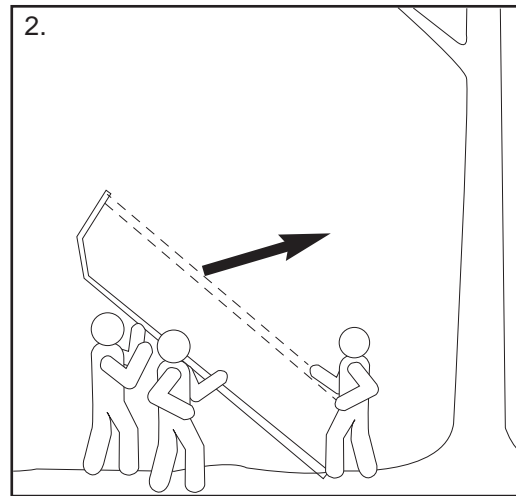

2. One person will stand at the base of ladder with his/her foot on bottom rung while holding installation straps. This will prevent tree stand from sliding. Two people will stand at opposite ends of tree stand, facing Platform and slowly walk tree stand upward using rungs of ladder.

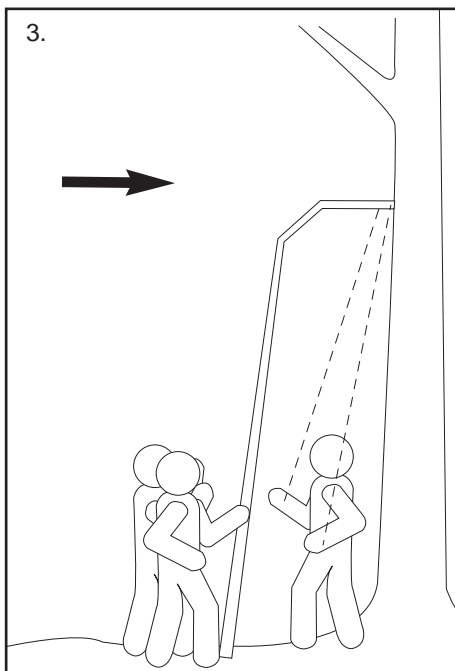

3. As tree stand is being raised, the person holding Installation Straps will pull toward themselves to take up slack. It will steady and ease the weight of stand on the other two people. Continue walking stand upward, until Tree Contact is resting against the tree.

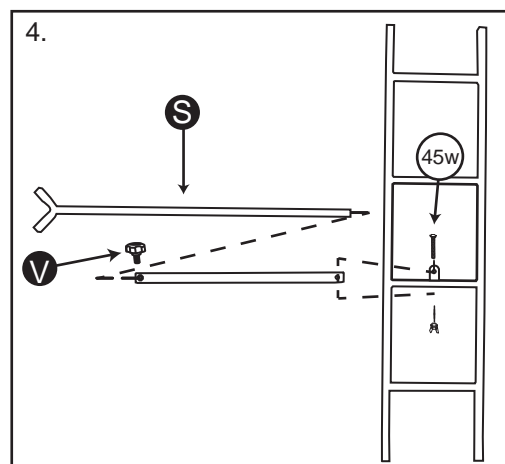

4. Slide the inner part of the Stabilizer Bar into the outer part. Attach Stabilizer Bar **S** to the second rung of the Middle Ladder Section with **1 - M12x45mm bolt and 1 wingnut**.

Insert the Adjustment Knob **V** in the Stabilizer bar at the proper adjustment point to the tree.

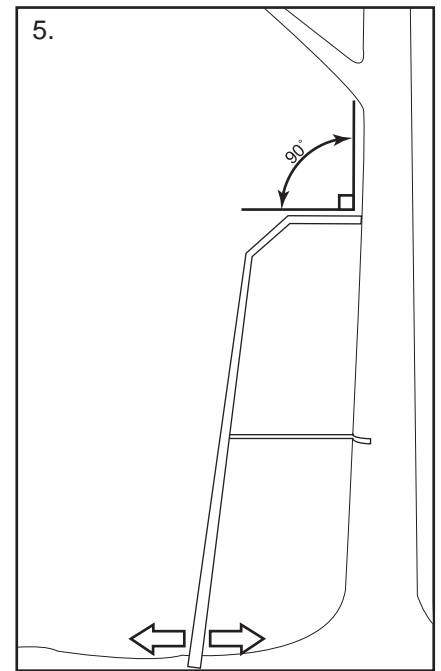

5. Move base of ladder toward or away from tree slightly in order to make Platform as parallel to the ground as possible.

Apply your full weight to the first step so it settles into the ground.

⚠ WARNING

DO NOT climb ladder without Stabilizer Bar or Installation Straps installed. Serious injury or death may occur if stabilizer bar is not installed.

⚠ WARNING

Stabilizer Bar and Installation Ropes **MUST** be secured prior to climbing the Ladderstand. Failure to comply may result in serious injury or death.

NOTE: Drawings are for illustration purposes only and may not depict actual product.



PRIMAL
VANTAGE CO.

Distributed by Primal Vantage Company Inc. 685 Route 10 East, Randolph, NJ 07869

CUSTOMER SERVICE DEPARTMENT 1-866-972-6168

©2013 (rev. 03/12)

WWW.PRIMALVANTAGE.COM

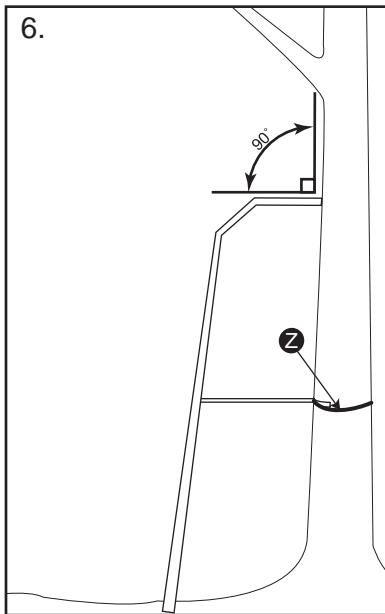

6. Attach Tiedown Rope **Z** just behind the brace of the inner part of Stabilizer Bar **S**.

Position the Stabilizer Bar against the tree and secure it by wrapping the rope around the back of the tree once and tie it to itself.

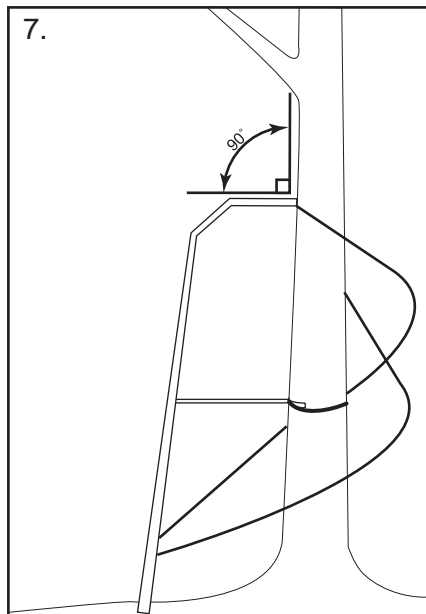

7. Cross Installation Straps behind tree. Attach to bottom ladder section by following the **Installation Strap Instructions**.

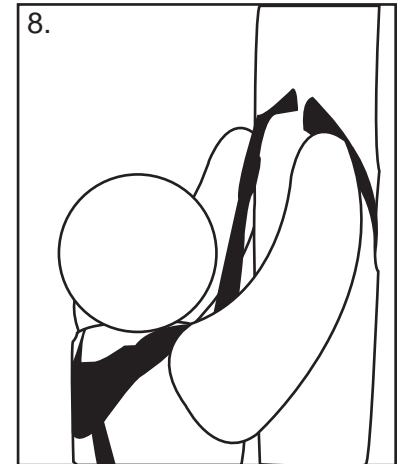

8. After the ladder stand has been secured to the tree with the installation straps, and the stabilizer bar has been securely attached to the tree, continue to have two people hold the ladder, climb cautiously up to the platform. Once you reach the top, **IMMEDIATELY ATTACH YOUR SAFETY HARNESS TO THE TREE**. Keep the tether strap above your head.

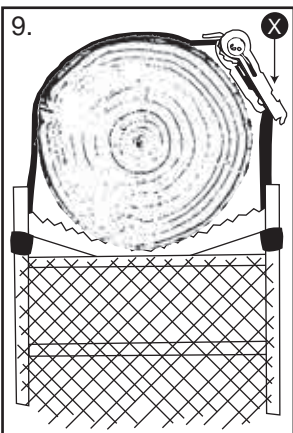

9. Wrap the strap of the ratchet around the back of the tree and thread it through the ratchet. (See Detailed Ratchet Instructions Below).

⚠ WARNING

DO NOT climb ladder without Stabilizer Bar or Installation Straps installed. Serious injury or death may occur if stabilizer bar is not installed.

⚠ WARNING

Stabilizer Bar and Installation Straps **MUST** be secured prior to climbing the Ladderstand. Failure to comply may result in serious injury or death.

DETAILED RATCHET STRAP INSTRUCTIONS



⚠ **WARNING** DO NOT sit on seat platform until the ratchet has been secured.

INSTALLATION STRAP INSTRUCTIONS



1. Place looped end of strap under platform.



2. Insert loose end of strap through the loop.

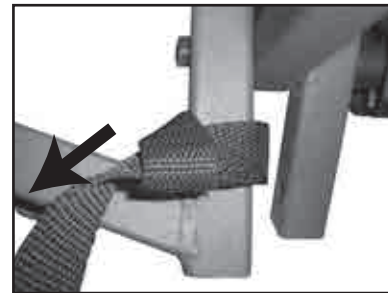

3. Pull to tighten. Continue with these steps to install the other strap on the other side of the platform.

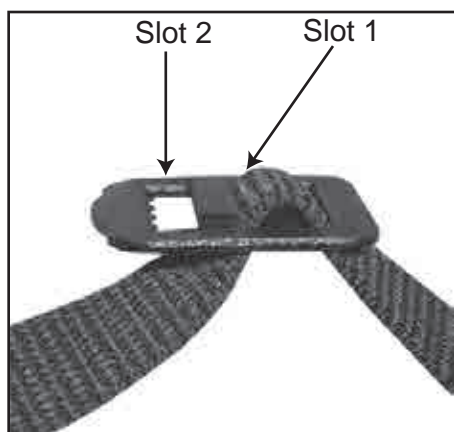

4. Place loose end of strap with clip, under the top rung of the bottom ladder section.

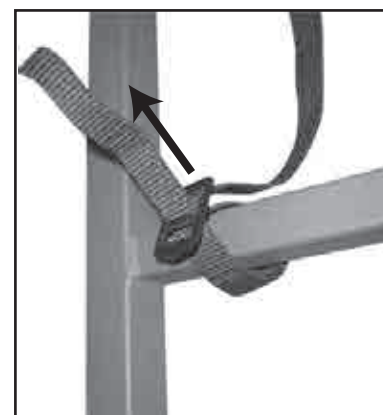

5. Insert the strap through Slot 1 on the clip.



6. Insert the strap through the Slot 2 with the teeth.

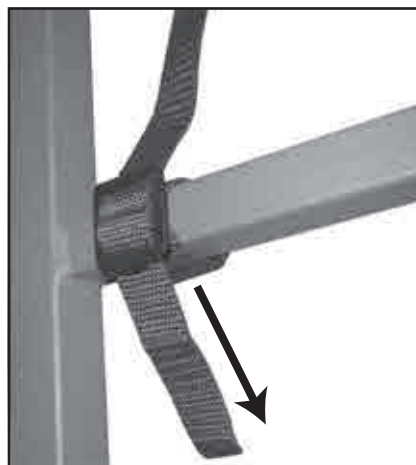

7. Pull strap to tighten.

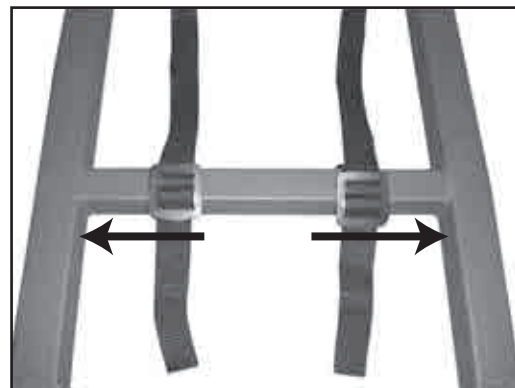

8. Slide the buckles out to the sides to create tension on the straps.



PRIMAL
VANTAGE CO.

Distributed by Primal Vantage Company Inc. 685 Route 10 East, Randolph, NJ 07869

WARNING DO NOT sit on seat platform until the ratchet and installation straps have been secured.

CUSTOMER SERVICE DEPARTMENT 1-866-972-6168

WWW.PRIMALVANTAGE.COM

Hunting For Low Prices?

These Items
Now Available at
Walmart and Walmart.com



20' STICK LADDER



HANG-ON TREESTAND



BONE COLLECTOR HANG-ON TREESTAND



CLIMBER

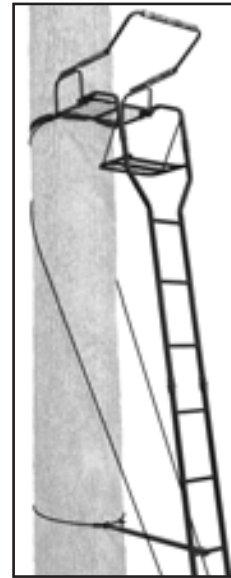

16' RECON LADDERSTAND

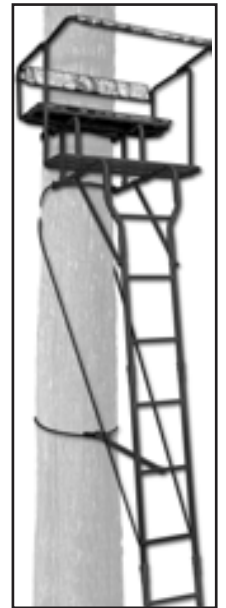

15' TWO-MAN LADDERSTAND

Check Out Walmart.com For Even More Tree Stands and Accessories



STEEL RAPID RAILS



BONE COLLECTOR AVENGER ALUMINUM HANG-ON TREESTAND



15' TRIPOD



TRIPOD ROOF KIT