

# DEER CART

**Model: PVDC-700**

- **Weight Capacity: 300 lbs.**

*Instruction and Safety Manual*



## **⚠ Warning**

### **THINK SAFETY!**

- **READ ALL INSTRUCTIONS PRIOR TO ASSEMBLING DEER CART**
- **DO NOT** assemble Deer Cart if any parts are missing or damaged
- **DO NOT** sit in or ride on Deer Cart. Sitting or riding on Deer Cart may result in serious injury or death
- **DO NOT** stand on Deer Cart. Standing on Deer Cart may result in serious injury or death.
- Weight limit of this Deer Cart is **300 lbs.**

## **⚠ Warning**

**Every year serious injury and even death occurs from hunting related falls.** To ensure your safety, please **COMPLETELY** read and follow this safety manual and **ALL** warning labels **BEFORE** assembling, installing or utilizing this product.

DO NOT USE THIS PRODUCT BEFORE FULLY UNDERSTANDING ALL SAFETY WARNINGS AND INSTRUCTIONS. IF YOU HAVE QUESTIONS, ARE UNSURE ABOUT ANY INFORMATION OR NEED ADDITIONAL INFORMATION CONCERNING YOUR PRODUCT, CONTACT OUR CUSTOMER SERVICE DEPARTMENT AT 1-866-972-6168 OR VISIT [WWW.TREESTANDCUSTOMERSERVICE.COM](http://WWW.TREESTANDCUSTOMERSERVICE.COM). KEEP AND MAINTAIN THIS SAFETY AND INSTRUCTION MANUAL IN A SAFE LOCATION FOR FUTURE REFERENCE.



# DEER CART

## Model: PVDC-700

• Weight Capacity: 300 lbs.

### PARTS LIST

<b>A</b>	1 Top Frame	Part # OTF-518
<b>B</b>	1 Bottom Frame	Part # OBF-518
<b>C</b>	2 Support Arm	Part # OSA-518
<b>D</b>	2 Wheel	Part # DW-224
<b>E</b>	2 Bushing	Part # DB-224
<b>F</b>	2 Large Washer	Part # DLW-224
<b>G</b>	2 Small Cotter Pin	Part # OCP-224
<b>H</b>	1 Large Cotter Pin	Part # DCP-224
<b>J</b>	2 Tie-Down Strap	Part # DS-224
<b>K</b>	1 Axle	Part # DA-518
<b>65</b>	2 M10x65mm Bolt <i>(Pre-Installed)</i>	Part # 1065
	6 M21 Quickclip	Part # 2115

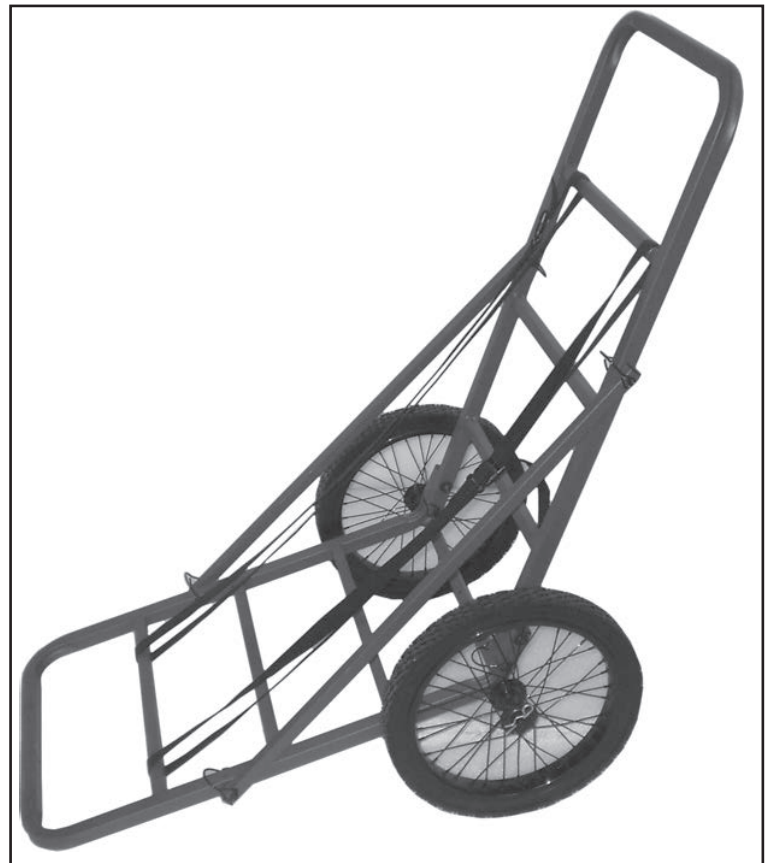
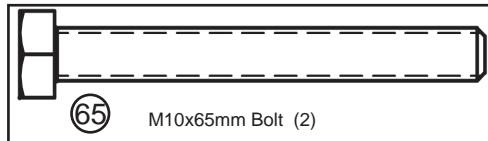
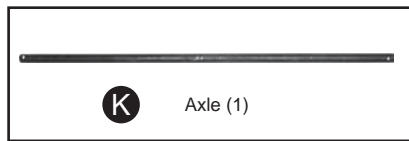
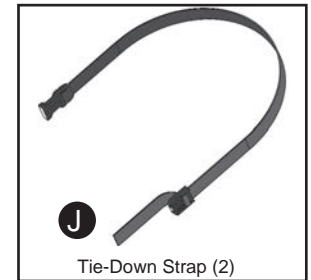
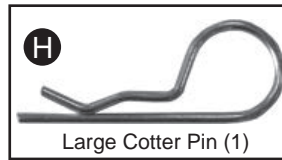
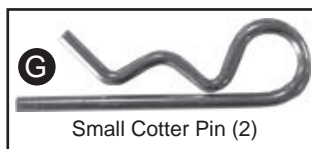
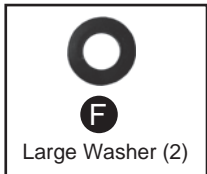
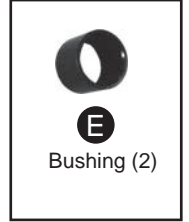
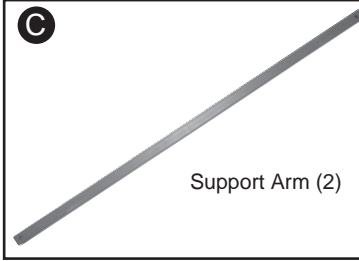
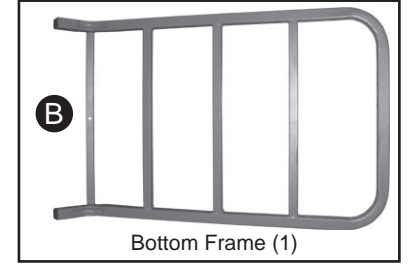
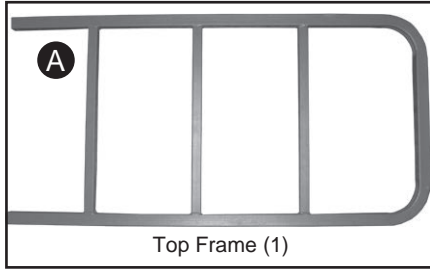

Distributed by Primal Vantage Company Inc. 685 Route 10 East, Randolph, NJ 07869

CUSTOMER SERVICE DEPARTMENT 1-866-972-6168

2012 (rev. 04/12)

WWW.TREESTANDCUSTOMERSERVICE.COM

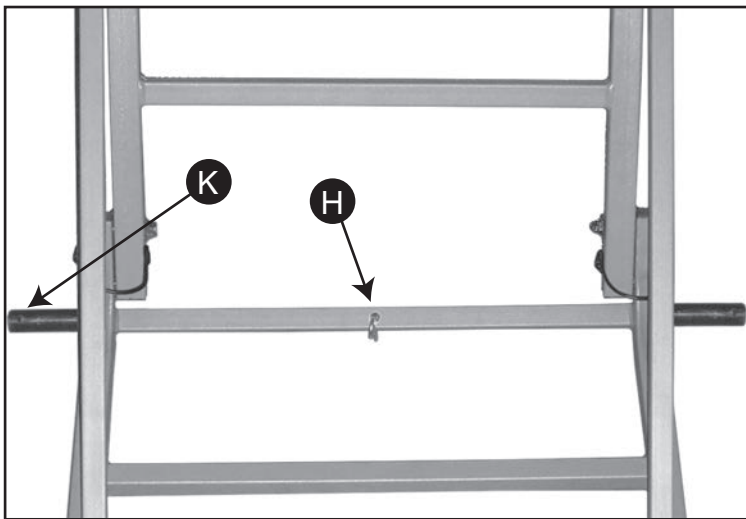
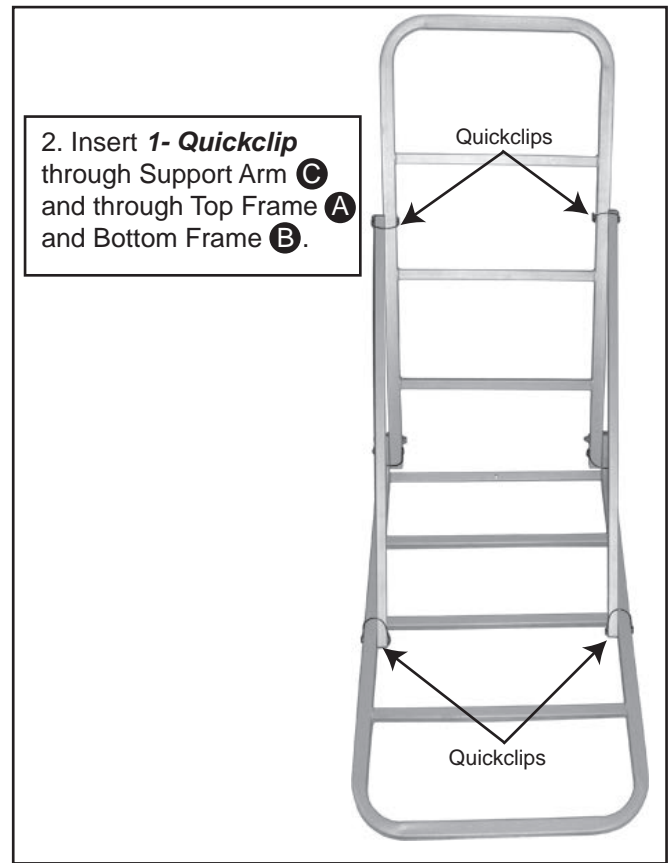
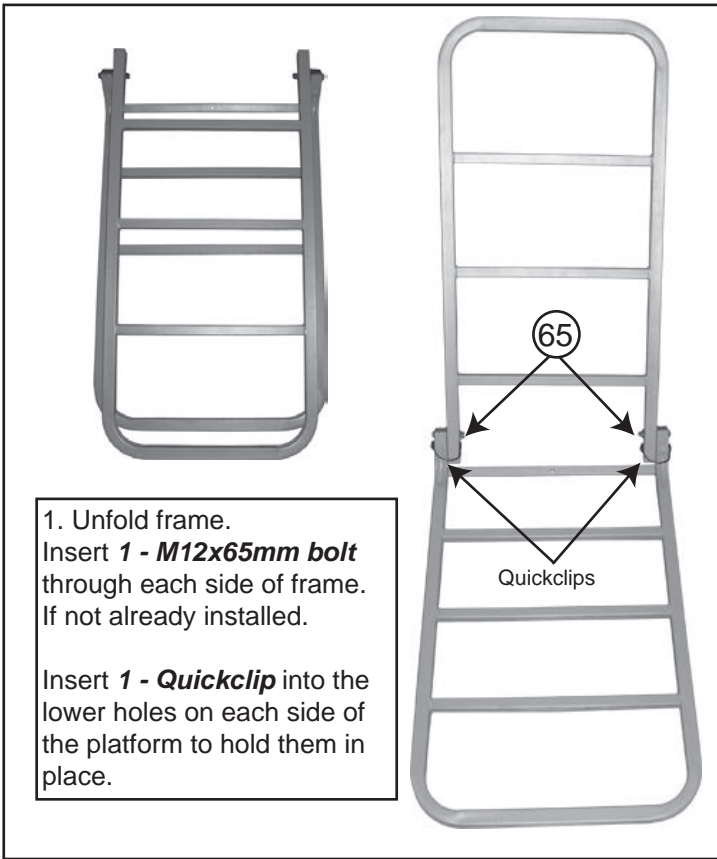

3. Insert Axle **K** through Bottom Frame **B**. Line the holes up on the axle and the center of the bottom frame. Insert Large Cotter Pin **H** to secure in place.

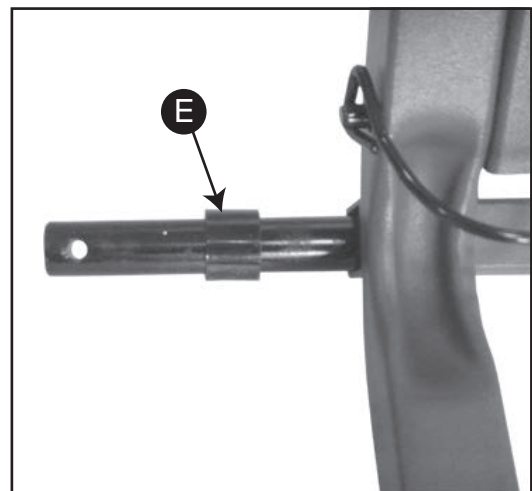

4. Slide Bushing **E** over each side of Axle **K**.



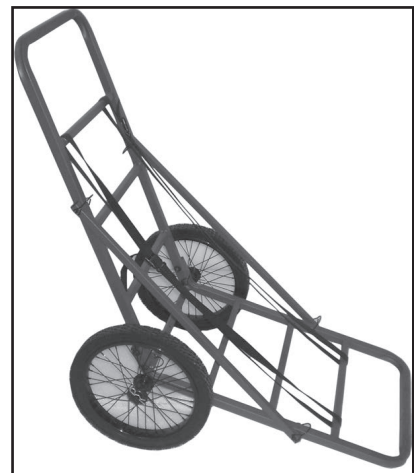
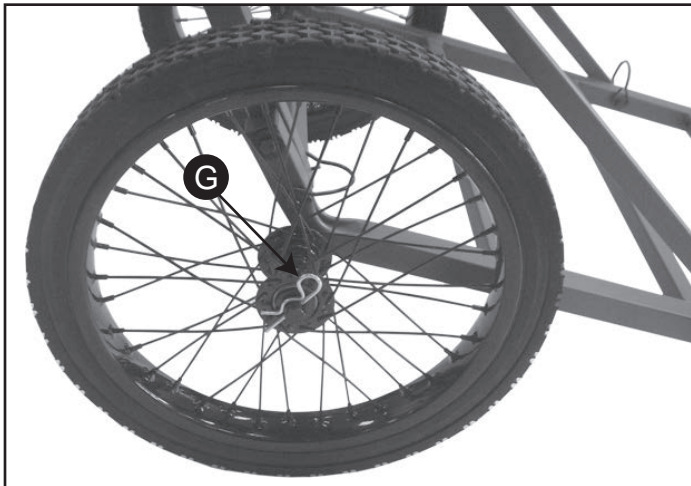
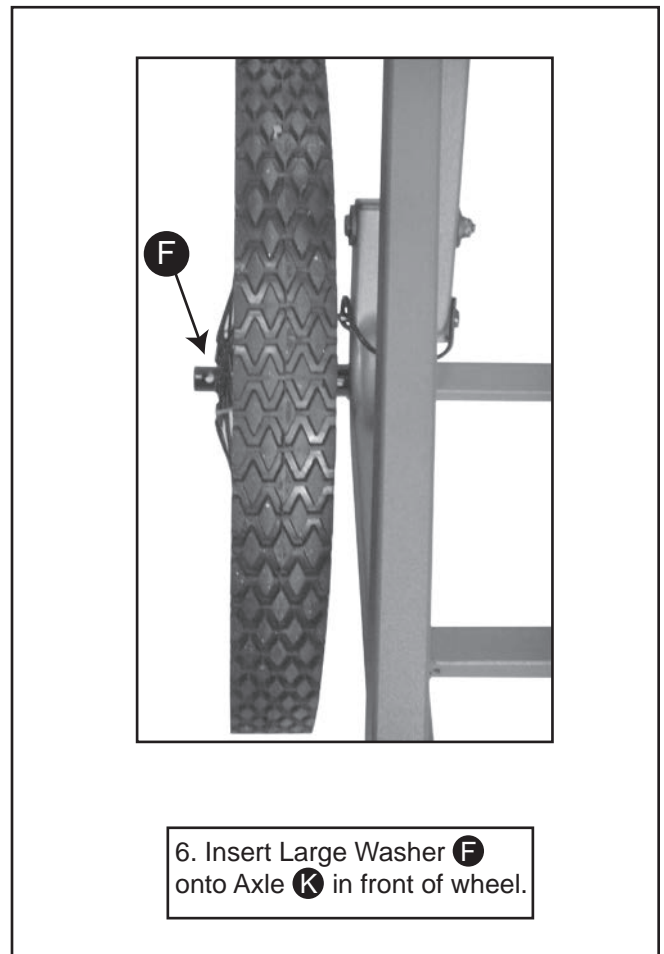
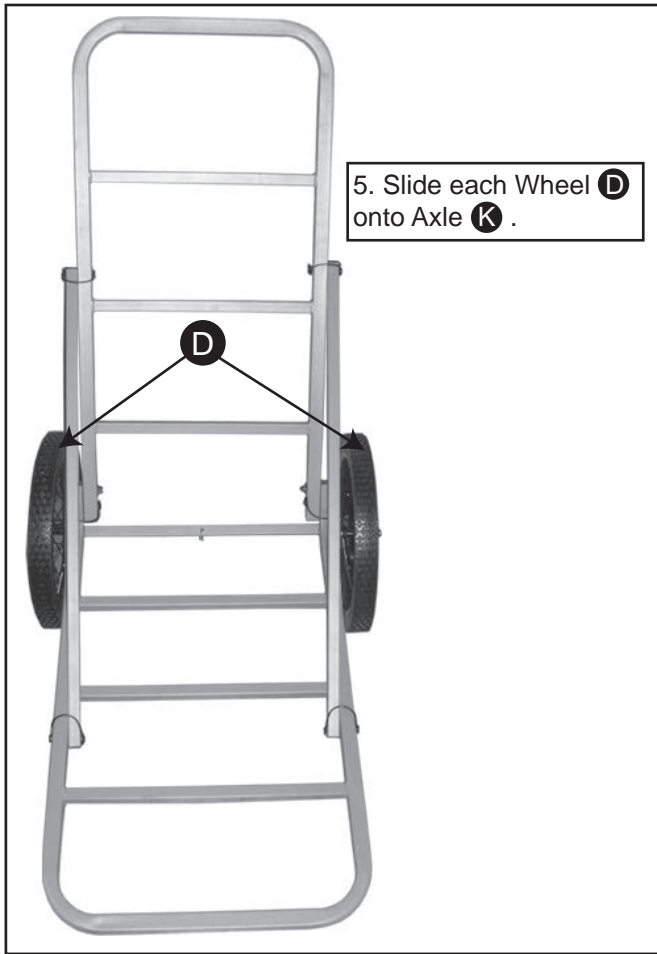

7. Insert Small Cotter Pin **G** into Axle **K** to hold the wheels in place.

8. Attach Tie-Down Straps **J** to Top and Bottom Frame.