

SIDE X SIDE

16.5' TWO PERSON LADDERSTAND

MODEL: HEH00581

- Always Wear a Safety Harness with this Product
- Practice Using at Ground Level
- Weight Limit: 500 lbs.
- Tree Size: 9"-18" diameter

Instruction and Safety Manual

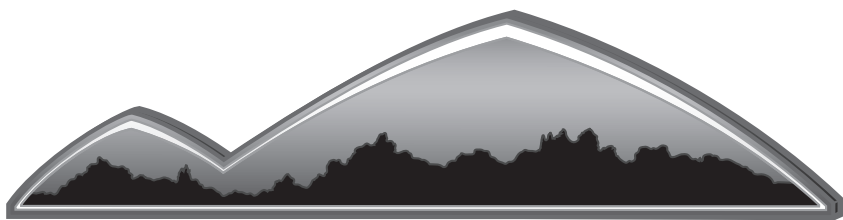
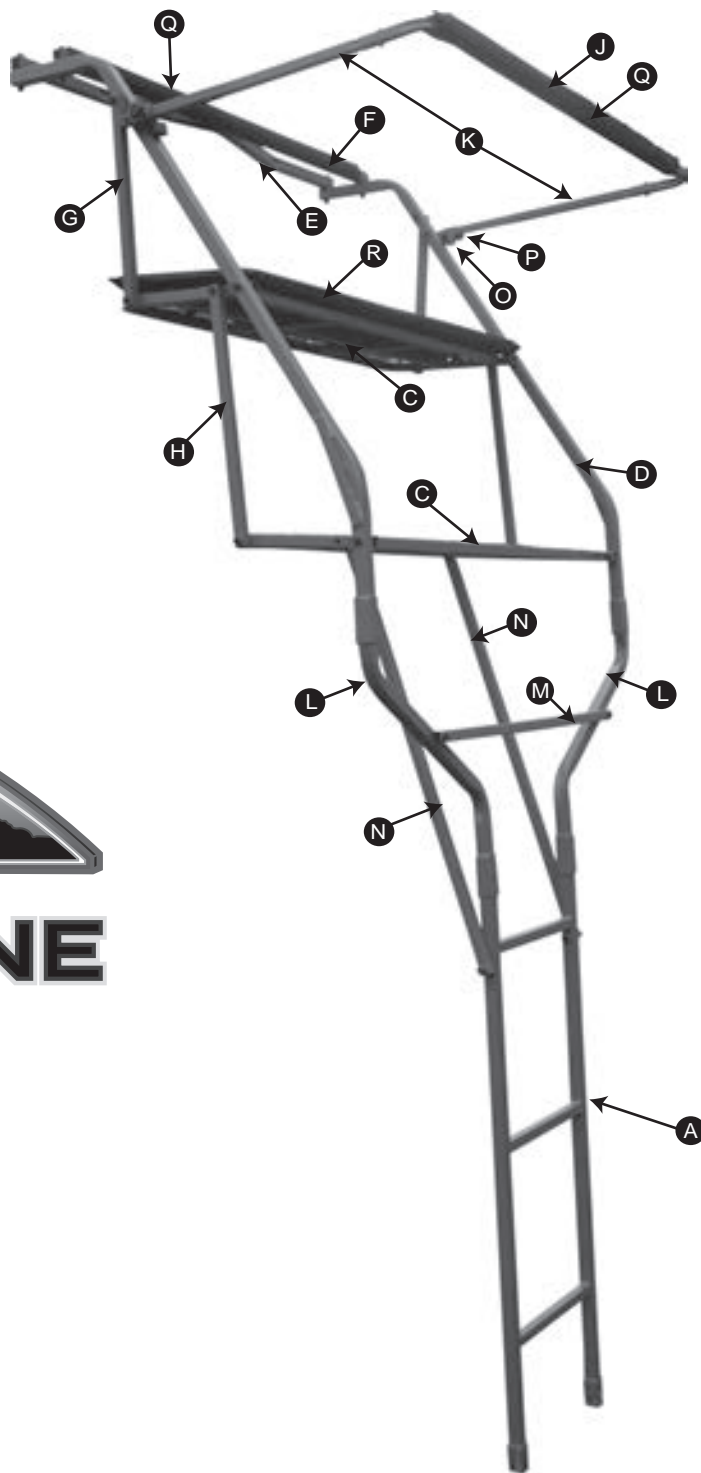

COMFORT ZONE



Warning

Every year serious injury and even death occurs from hunting related falls. To ensure your safety, please **COMPLETELY** read and follow this safety manual and **ALL** warning labels **BEFORE** assembling, installing or utilizing this product.

DO NOT USE THIS PRODUCT BEFORE FULLY UNDERSTANDING ALL SAFETY WARNINGS AND INSTRUCTIONS. IF YOU HAVE QUESTIONS, ARE UNSURE ABOUT ANY INFORMATION OR NEED ADDITIONAL INFORMATION CONCERNING YOUR PRODUCT, CONTACT OUR CUSTOMER SERVICE DEPARTMENT AT 1-866-972-6168 OR VISIT WWW.TREESTANDCUSTOMERSERVICE.COM. KEEP AND MAINTAIN THIS SAFETY AND INSTRUCTION MANUAL IN A SAFE LOCATION FOR FUTURE REFERENCE.

TREESTAND SAFETY WARNINGS

Please read the following instruction manual and warnings labels completely before utilizing this product. Failure to understand and execute the instructions and warnings may result in serious injury or death. In the event of an accident, have a plan for rescue, including the use of devices that may be easily reached while suspended.

ALWAYS read and understand all warnings and instructions and use all safety products provided before each use of this product. Failure to read and understand all warnings and instructions may result in serious injury or death. Contact a Customer Service Representative with any questions you may have.

NEVER exceed total weight limit of **500 lbs.** **DO NOT** use if your combined weight with all of your hunting gear and any accessories exceeds **300 lbs.** or the combined weight of two people and equipment exceeds **500 lbs.** **DO NOT exceed the weight limit of the safety harness, refer to harness manufacturer's warnings for weight limit of safety harness.** Use of tree stand over the weight limit may result in serious injury or death.

DO NOT use this tree stand while under the influence of alcohol, medication or any illegal substances. Use of tree stand while under the influence of any of these substances may result in serious injury or death.

NEVER use this treestand during inclement weather. **DO NOT** use tree stand during thunderstorms, snowstorms, hurricanes, tornadoes or any other weather conditions that include (but not limited to) lightning, icy conditions, or high winds that could create slippery or dangerous situations. End your hunt and return to the ground if inclement weather conditions arise.

NEVER use treestand if you are feeling ill, nauseous, dizzy or if you have a prior condition that could cause a problem. i.e., heart condition, joints that lock-up spinal fusions, etc., or if you are not well rested and alert. Physical ailments can reduce your ability to safely install, utilize, and remove your treestand. Please consult a physician prior to use.

NEVER use this tree stand if you have a history of health problems such as (but not limited to) heart problems, back problems, high blood pressure, impaired vision, equilibrium impairments, are afraid of heights, have been advised by a doctor or physician not to climb. If you are not physically fit, well rested, and alert, or if you have any other physical or mental condition that would impair your ability to properly use this treestand.

NEVER use this tree stand on a tree that is dead, leaning, diseased, loose barked or on a utility pole as the tree may fall, break, or uproot and may result in serious injury or death. **NEVER** rely on a branch for support.

NEVER jump or bounce on the treestand's platform or ladder sections to seat it to the tree. Instead, step firmly on the first rung of the bottom ladder section to set the ladder into the ground before proceeding to climb the ladder.

NEVER transport any of your equipment with yourself while ascending or descending the tree. You will need to have two hands free during ascending and descending for safety. Use a haul line to pull up your firearm (unloaded, chamber opened with safety lock engaged, barrel facing towards the ground), bows, arrows, knives or any other equipment to your tree stand once you have reached your desired hunting height. **ONLY** pull up hunting equipment after the tree stand has been secured to the tree and after you and your harness have been secured to the tree. Prior to descending, lower your equipment on the opposite side of the tree from which you are climbing. Make sure that the unloaded firearm's safety lock is engaged and the gun barrel is pointing towards the ground.

ALWAYS hunt with a plan and a buddy. Before you leave home, let others know your exact location, when you plan to return and who is with you.

ALWAYS carry emergency signal devices such as a cell phone, walkie-talkie, whistle, signal flare, PLD (personal location device) and flashlight with you at all times and within reach even while you are suspended in your harness. Watch for changing weather conditions. In the event of an accident, remain calm and seek help immediately.

ALWAYS inspect the tree stand and the **Fall Arrest System (FAS)** (Harness) for signs of wear or damage **BEFORE** each use. Also inspect to ensure that nuts and bolts are secure. Pay special attention to the harness and straps, guaranteeing that nothing has been frayed or severed. Destroy all products that cannot be repaired by the manufacturer. Contact a Customer Service Representative for replacement parts. The Fall Arrest System **MUST** be discarded and replaced after a fall has occurred.

DO NOT ATTACH YOUR FULL BODY HARNESS TO YOUR TREESTAND.

NEVER modify your treestand in any way by making repairs, replacing parts, or altering adding or attaching anything to it except if explicitly authorized in writing by the manufacturer. Improper installation or adjustment may cause serious injury or death. Remove all contents from box. Inspect for any damaged or missing parts. If any parts are missing or damaged, you must only use certified replacement parts. Using any other replacement parts will void product warranty. **THERE ARE NO EXTRA PARTS.** All parts **MUST** be used to ensure the safety of you and your stand. If you think parts are missing or damaged, **STOP IMMEDIATELY** and contact our Customer Service Department. Using the tree stand with missing or damaged parts may result in serious injury or death. **DO NOT** return this product to the retailer. Contact a Customer Service Representative if you have any missing, damaged or extra parts.

PRACTICE installing, adjusting and using your treestand at ground level prior to using it at an elevated position.

ALWAYS keep instructions (written and video) in a safe place and review before each use. It is the responsibility of the treestand owner to furnish the complete instructions to anyone who borrows or purchases the treestand from you. A safe treestand hunting video has been included. Please view it in its entirety prior to using this product.

NEVER use this treestand for any use other than hunting. Our treestands are designed for hunter's to wear a Full Body Harness. If you are not completely comfortable and confident with your ability to safely install, ascend, hunt and descend using a Full Body Safety Harness and this treestand, **DO NOT PROCEED.**

NEVER use this treestand for trimming trees.

NEVER fall asleep in your stand as you may fall out resulting in serious injury or death.

ALWAYS be sure to retighten all bolts **BEFORE** each new use of treestand.

ALWAYS have a minimum of three people present when installing or removing this treestand.



©2012 (rev. 12/11)

CHOOSING A SAFE TREE

- **ALWAYS** thoroughly inspect the tree before installing your product. **DO NOT** install your **TREE/LADDER STAND** onto any dead or unsafe tree, telephone or utility pole, structural column, or man-made structure. Doing so may result in serious injury or death.
- **ALWAYS** select the proper tree for use with your **TREE/LADDER STAND**. Select a live straight tree that fits within size limits recommended (minimum tree diameter must be no less than 9 inches and maximum of 18 inches.). **DO NOT** rely on a branch for support.
- **DO NOT** select a tree in the dark or choose a tree in close proximity to a fence. You must not have any stumps or rocks beneath your tree.
- **NEVER** use **TREE/LADDER STAND** on a tree that is dead, diseased, leaning or on wet and uneven ground as the tree may fall, break or uproot.
- Your tree must not be wet, icy or slippery or on wet, swampy, or loose ground that allows the tree to be unstable. Check the ground under **TREE/LADDER STAND** to ensure it is firm and level.
- Be sure you have a level stand platform. Your tree must not lean or have any irregular shape.
- Tree must not have any loose or scaly bark or excessive vines, nails, screws, or any other sharp objects protruding that may sever webbing on product. Any surrounding trees must not lean or have dead limbs that may fall onto you or your product.
- **NEVER HURRY!! HURRYING CAUSES ACCIDENTS!!** While climbing a **TREE/LADDER STAND**, make slow, even movements no more than ten to twelve inches at a time. Make sure you have proper contact with tree and/or **TREE/LADDER STAND** every time you move. On ladder tree stand, **ALWAYS** maintain three points of contact with each step and **ALWAYS** lean forward as you climb.

Several treestands are equipped with a footrest, armrests and/or shooting rail. Neither the footrest, armrests nor the shooting rail have been designed to support a user's weight. Under **NO** circumstances should you place more than fifteen (15) pounds of weight on these structures. Doing so will put the user in serious risk of injury or death.

PROPER CARE AND MAINTENANCE:

- Inspect for defects (damage, rot, corrosion, cracks, freezing, excessive heat, etc.) before every use is required. Do not use if damage is detected or suspected.
- We recommend replacing all hardware/cables/nuts/bolts/clips on your tree stand every two (2) years or sooner if inspection finds it necessary. Use only Primal Vantage approved replacement straps and parts. Use of any other straps or parts, will be viewed as a modification to the product. Any modification will void the warranties and relieve Primal Vantage from all liabilities. Failure to follow these instructions may result in serious injury or death.
- By registering your product, you may be enrolled in our discount program. You may receive a 20% off coupon for our website store, www.primal-store.com to purchase replacement parts in the future.
- **DO NOT** overtighten the hardware. **DO NOT** use a socket wrench. This can lead to structural damage and may negatively affect the performance of your stand. Failure to follow these instructions may result in serious injury or death.



SIDE X SIDE

16.5' LADDER TREESTAND

MODEL: HEH00581

- Always Wear a Safety Harness with this Product
- Practice Using at Ground Level
- Weight Limit: 500 lbs.
- Tree Size: 9"-18" diameter

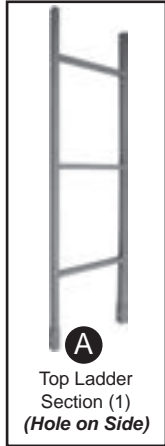

A Top Ladder Section (1)
(Hole on Side)

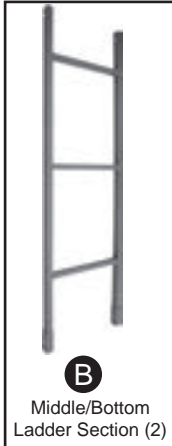

B Middle/Bottom Ladder Section (2)

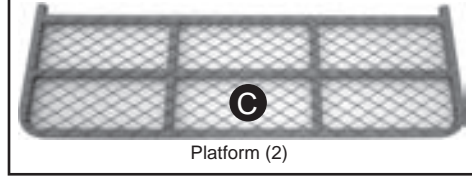

C Platform (2)



D Handle Rail (2)



E Tree Brace (1)

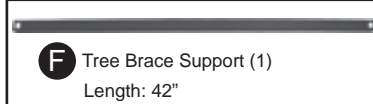

F Tree Brace Support (1)
Length: 42"

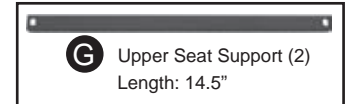

G Upper Seat Support (2)
Length: 14.5"

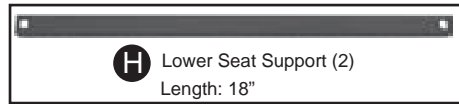

H Lower Seat Support (2)
Length: 18"

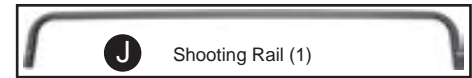

J Shooting Rail (1)

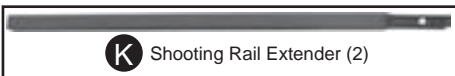

K Shooting Rail Extender (2)

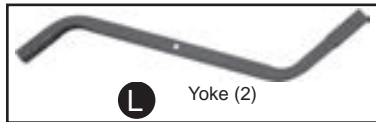

L Yoke (2)



M Step (1)
Length: 28"



N Platform Support (2)
Length: 34"



O Shooting Rail Adjuster (2)



P Shooting Rail Knob (2)



Q Rail Covers (2)



R Seat Cushion (1)



S Adjustment Knob (1)

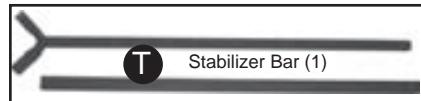

T Stabilizer Bar (1)



W Tiedown Rope (1)



X Installation Cross Strap (2)



Z Ratchet Strap (1)

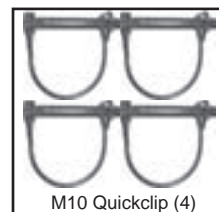

M10 Quickclip (4)

PARTS LIST

A	1 Top Ladder Section	Part # DL-5800
B	2 Middle/Bottom Ladder Section	Part # DL-5810
C	2 Platform	Part # DP-581
D	2 Handle Rail	Part # DHR-581
E	1 Tree Brace	Part # DTB-581
F	1 Tree Brace Support	Part # DTBS-581
G	2 Upper Seat Support	Part # DUSS-581
H	2 Lower Seat Support	Part # DLSS-581
J	1 Shooting Rail	Part # DSR-581
K	2 Shooting Rail Extender	Part # DSX-581
L	2 Yoke	Part # DYK-581
M	1 Step	Part # DS-581
N	2 Platform Brace	Part # DPB-581
O	2 Shooting Rail Adjuster	Part # DSA-581
P	2 Shooting Rail Knob	Part # DSRK-581
Q	2 Rail Cover	Part # DPRC-581
R	1 Seat Cushion	Part # DSC-581
S	1 Adjustment Knob	Part # AK-100
T	1 Stabilizer Bar	Part # DSB-500
W	1 Tiedown Rope	Part # TR-1000
X	2 Installation Cross Strap	Part # ICS-1000
Z	1 Ratchet Strap	Part # RA-100

HARDWARE

65	2 M12x65mm Bolt	Part # 1265
60	12 M12x60mm Bolt	Part # 1260
55	8 M12x55mm Bolt	Part # 1255
61	2 M10x60mm Bolt w/ bushing	Part # 1061
25	2 M10x25mm Bolt	Part # 1025
45w	1 M12x45mm w/wingnut	Part # 1245W
	2 Harness	Part # 2012
	4 M10 Quickclip	Part # 1615



PRIMAL
VANTAGE CO.

Distributed by Primal Vantage Company Inc. 685 Route 10 East, Randolph, NJ 07869

CUSTOMER SERVICE DEPARTMENT 1-866-972-6168

©2012 (rev. 03/12)

WWW.TREESTANDCUSTOMERSERVICE.COM

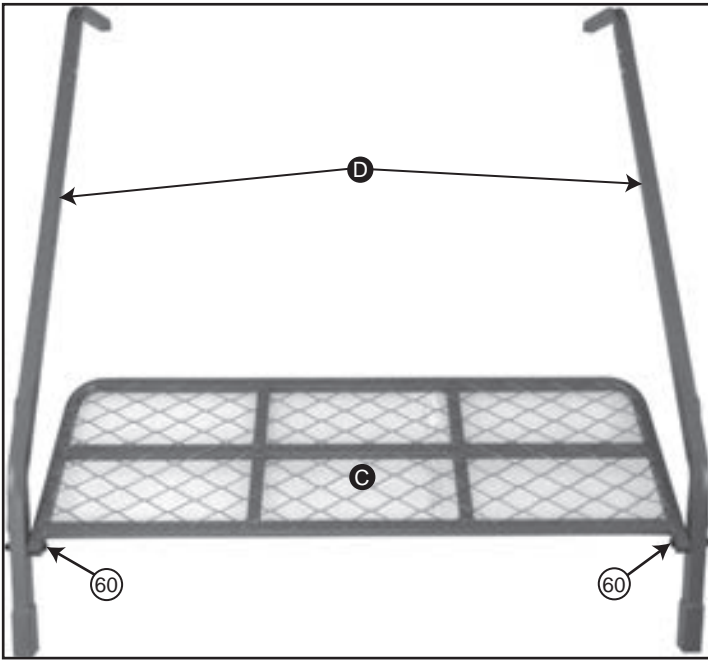

1. Attach each Handle Rail **D** to one Platform **C** using **1-M12x60mm Bolt** on each side.

NOTE: Handle Rails are interchangeable.
NOTE: Platforms are identical.



2. Attach remaining Platform **C** to Handle Rail **D** using **1-M12x60mm Bolt** on each side.

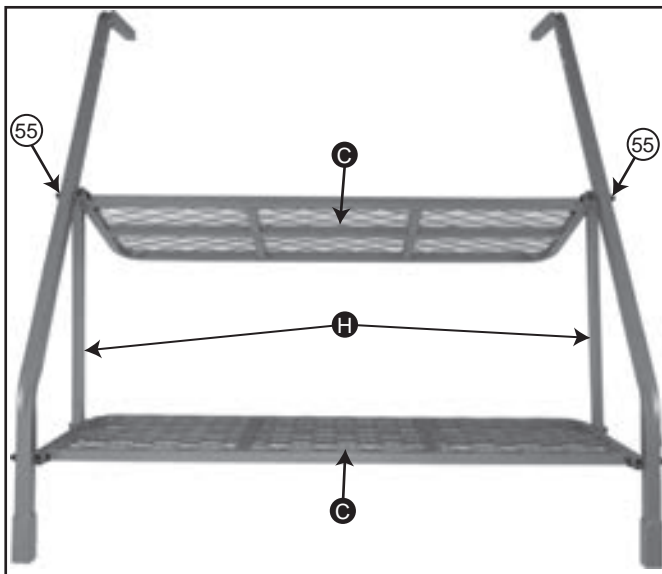

3. Attach one end of Lower Seat Support **H** to the hole near the rounded edge of Lower Platform **C** using **1-M12x55mm Bolt** on each side.

Attach the other end of Lower Seat Support **H** to Upper Platform **C** through the hole closest to Handle Rail **D** using **1-M12x55mm Bolt** on each side. **DO NOT** attach to the rounded edge.

SEE CLOSEUP

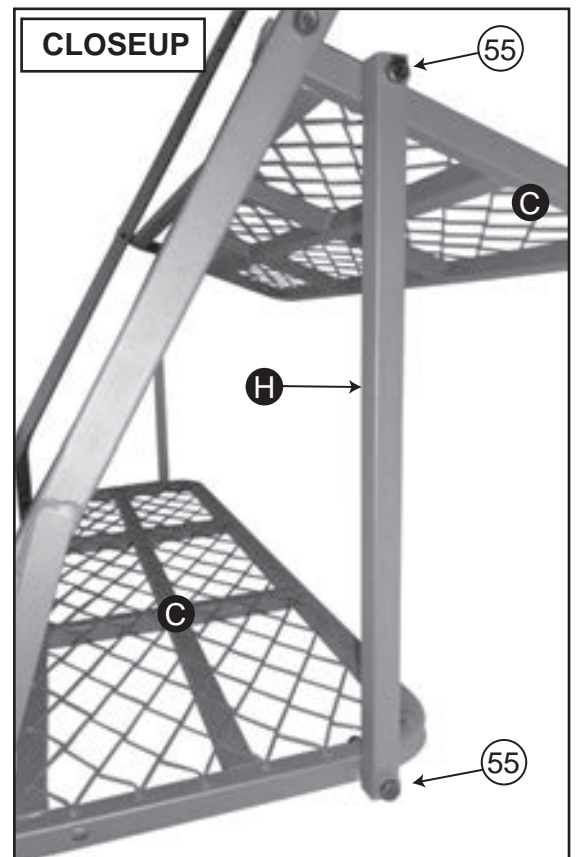

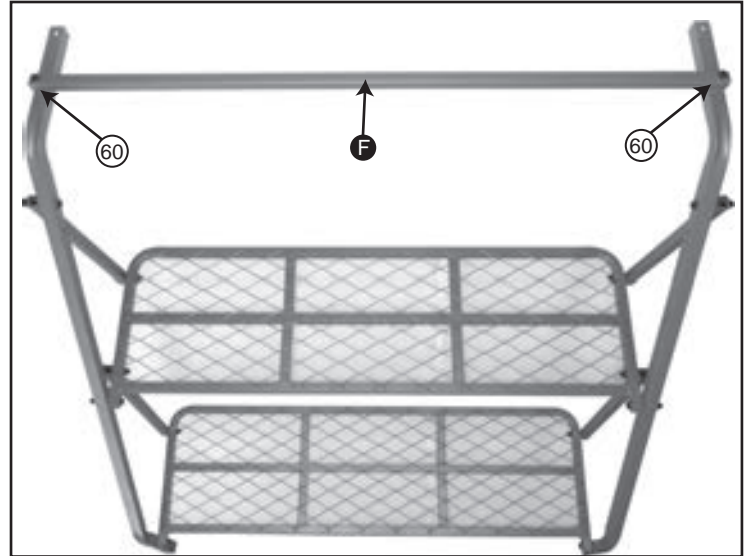
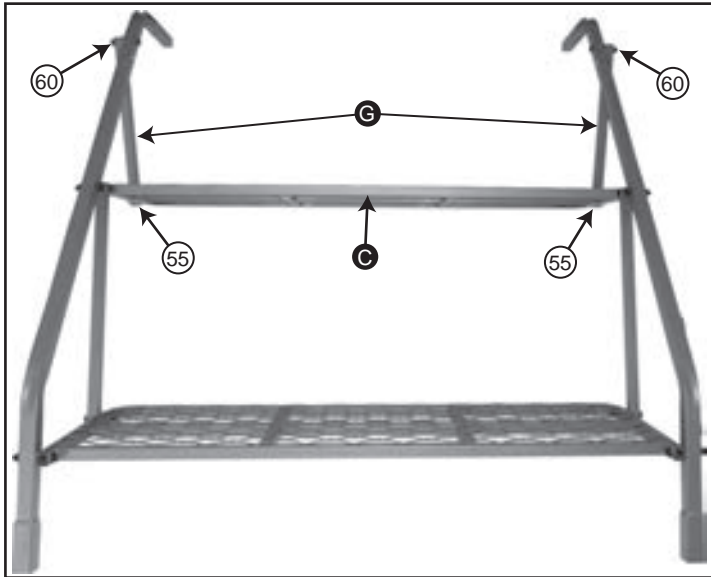

4. Attach one end of Upper Seat Support **G** to the hole near the rounded edge of Upper Platform **C** using **1-M12x55mm Bolt** on each side.

Attach the other end of Upper Seat Support **G** to Handle Rail **D** using **1-M12x60mm Bolt** on each side.

5. Attach Tree Brace Support **F** to the innermost hole on the rear of Handle Rails **D** using **1-M12x60mm Bolt** on each side.

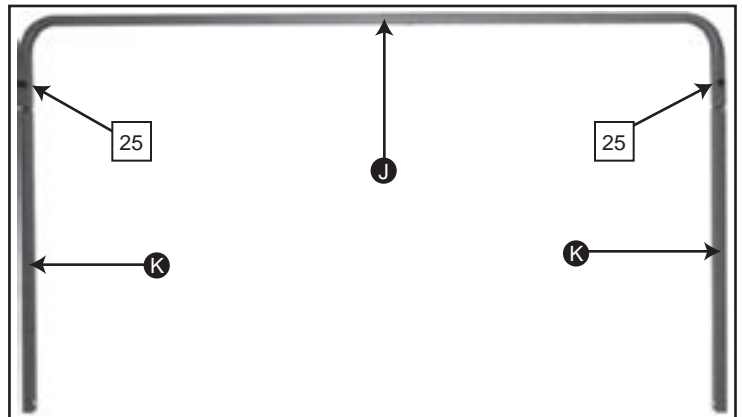
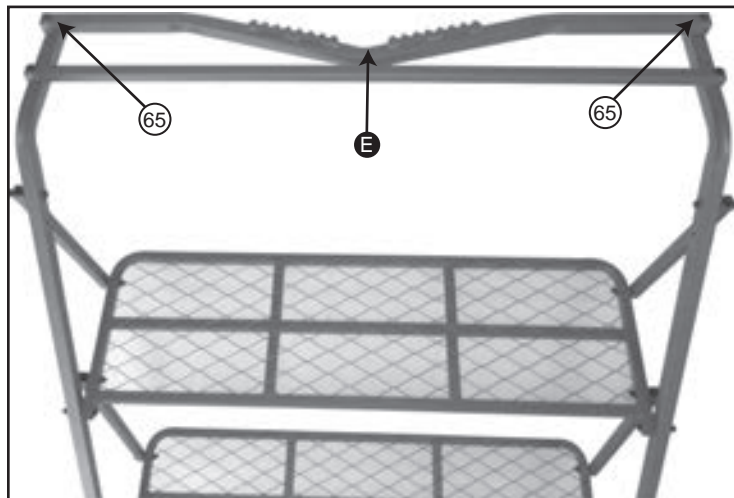

6. Attach Tree Brace Support **E** to the rear of Handle Rails **D** using **1-M12x65mm Bolt** on each side.

7. Insert each Shooting Rail Extender **K** into Shooting Rail **J**. Secure with **1-M10x25mm Bolt** on each side.

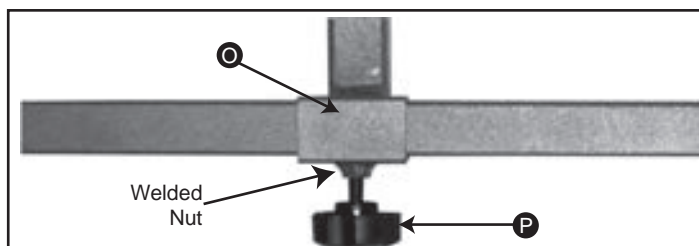

8. Slide Shooting Rail Adjuster **O** onto end of Shooting Rail Extender **K**. Make sure the welded nut is facing the outside. Use Shooting Rail Knob **P** to secure.





9. Attach assembled Shooting Rail to Handle Rail **D** using **1-M10x60mm Bolt w/bushing**.

See Closeup for Installation.

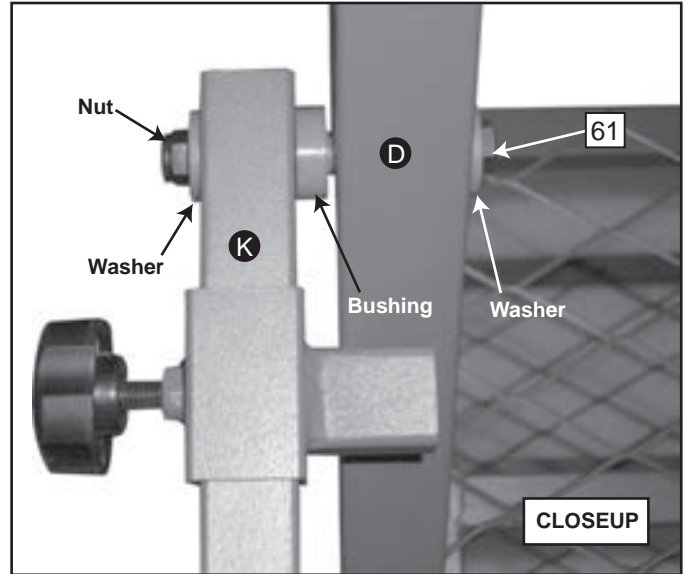

Insert the bushing into Handle Rail first. Then Insert a washer onto the bolt. Insert the bolt through the Handle Rail and bushing. Continue through the Shooting Rail. Add the last washer and tighten the nut.



10. Attach Seat Cushion **R** to Upper Platform **C** .
 Attach Rail Cover **Q** to Shooting Rail **J** .
 Attach Rail Cover **Q** to Tree Brace Support **F** .



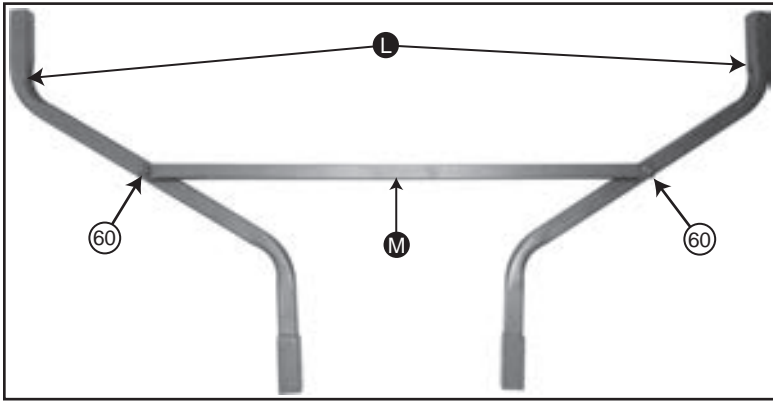

11. Attach Step **M** to each Yoke **L** using **1-M12x60mm Bolt**.

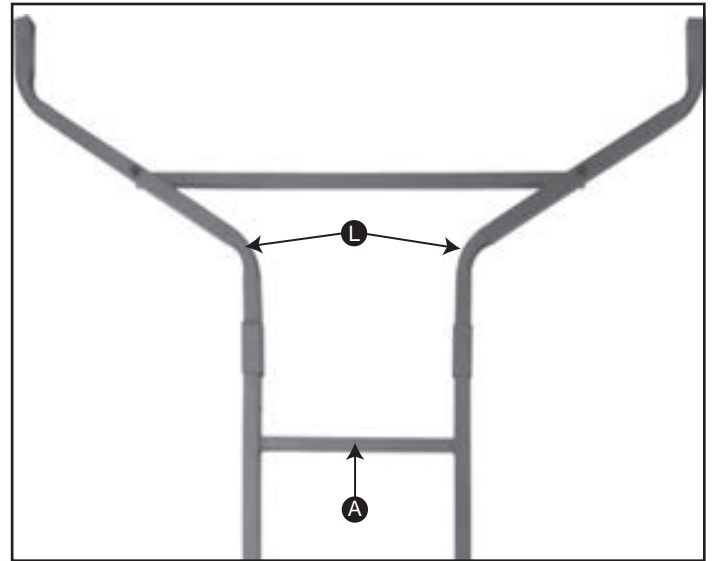

11. Insert Top Ladder Section **A** into each Yoke **L**.

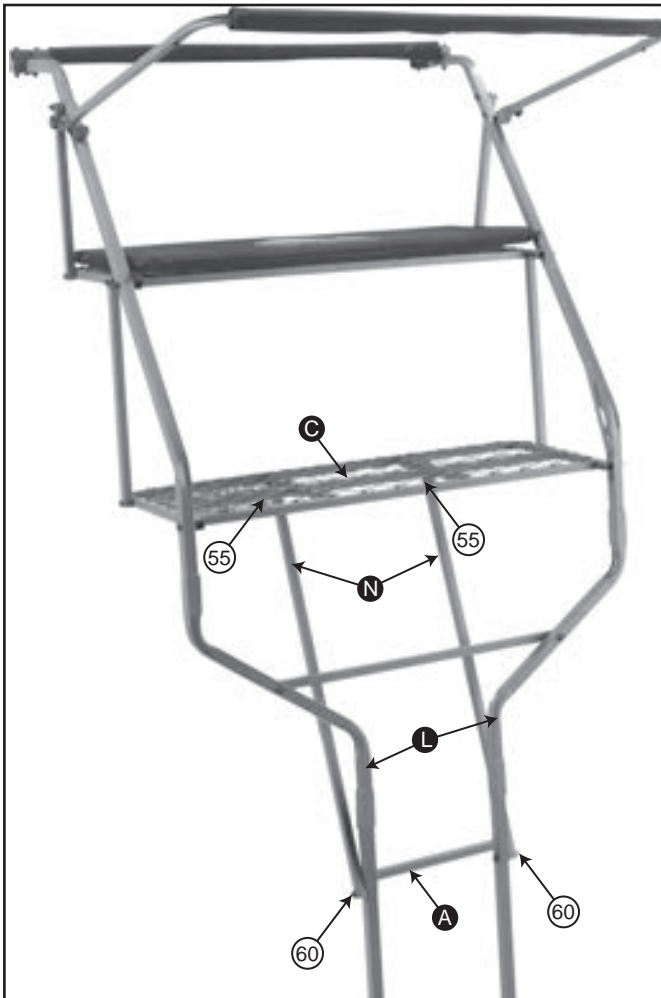

12. Insert assembled Top Ladder into each Handle Rail **D**.
 Make sure the step is on the inside of the ladder.

13. Attach one end of both Platform Braces **N** to the underside of the Lower Platform **C** using **1-M12x55mm Bolt**.
 Attach opposite end of both Platform Braces **N** to the sides of Top Ladder Section **A** using **1-M12x60mm Bolt**.



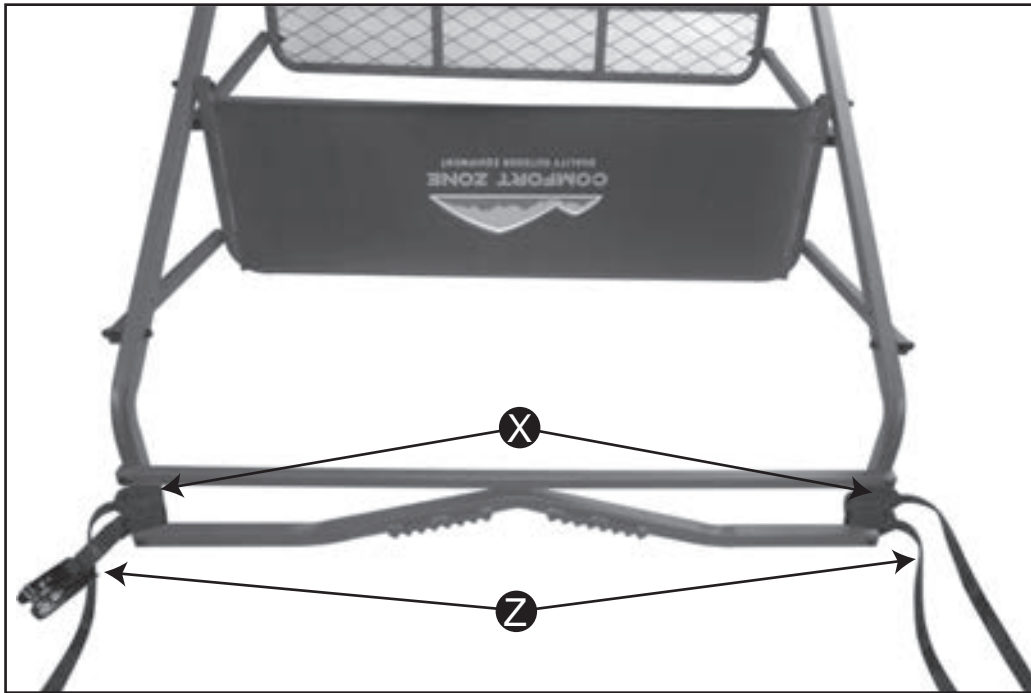

14. Attach Ratchet Strap **Z** between Tree Brace and Tree Brace Support. **(See Ratchet Instructions).**

Attach each Installation Strap **X** just behind the Ratchet Straps between Tree Brace and Tree Brace Support. **(See Installation Strap Instructions).**

LADDER ASSEMBLY

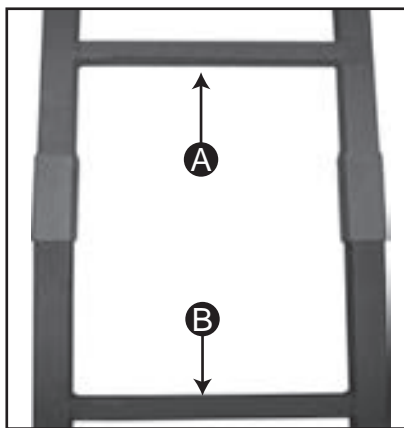

1. Insert Ladder Section **B** into the sleeved end of Top Ladder Section **A**.



2. Insert **1 - Quickclip** through the hole on the sleeve, and through the ladder sections on each side of the ladder.



3. Close the quickclip to secure the ladder sections together.

4. Follow **Steps 1-3 above** to attach the bottom section to the middle section.



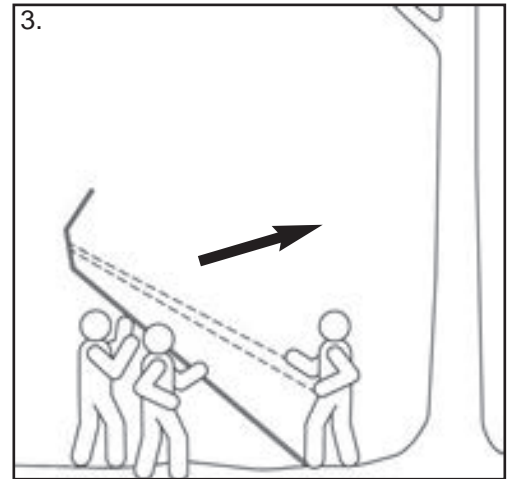
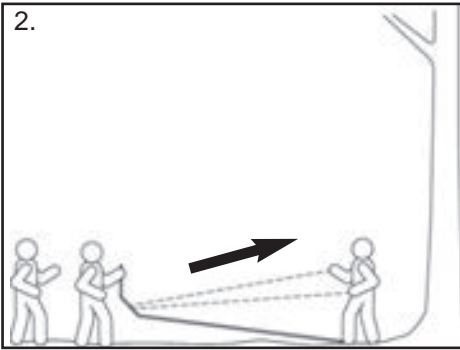
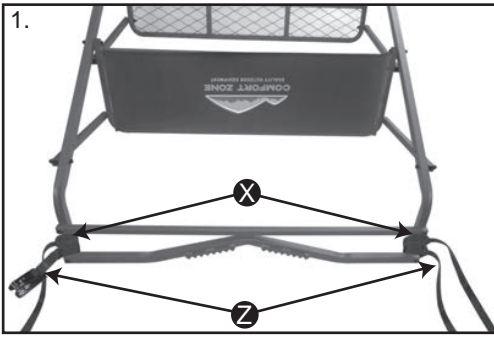

1. Make sure Installation Straps **X** and Ratchet Strap **Z** are attached and secured.

2. Position bottom of stand 4-5 feet from base of tree.

3. One person will stand at the base of ladder with his/her foot on bottom rung while holding installation straps. This will prevent tree stand from sliding. Two people will stand at opposite ends of tree stand, facing Platform and slowly walk tree stand upward using rungs of ladder.

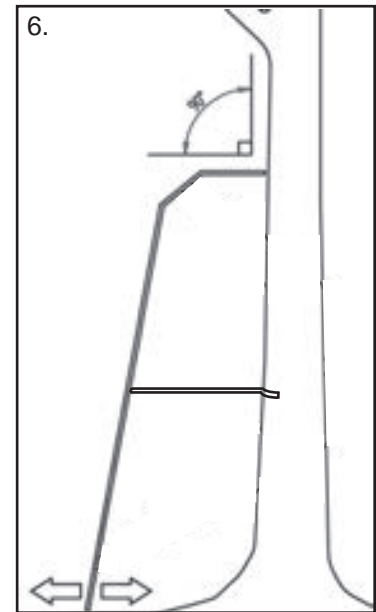
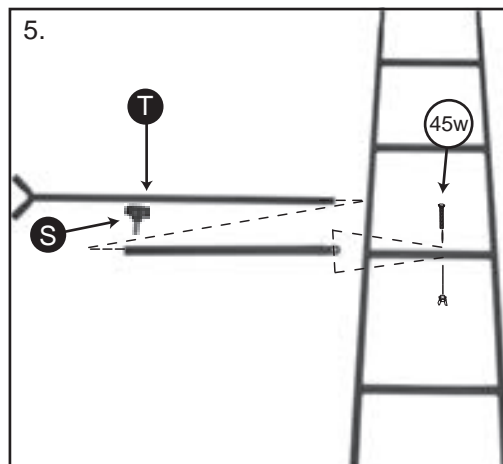
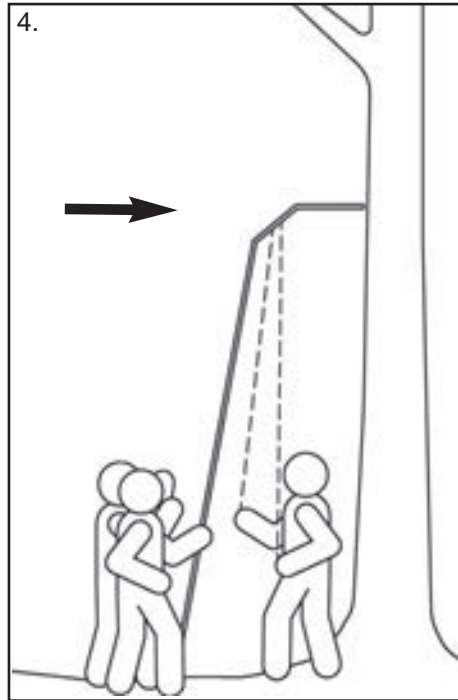

5. Slide the inner part of the Stabilizer Bar into the outer part. Attach Stabilizer Bar **T** to the second rung of the Middle Ladder Section with 1 - **M12x45w bolt** and 1 **wingnut**.
Insert the Adjustment Knob **S** in the Stabilizer bar at the proper adjustment point to the tree.

4. As tree stand is being raised, the person holding Installation Straps will pull toward themselves to take up slack. It will steady and ease the weight of stand on the other two people. Continue walking stand upward, until Tree Contact is resting against the tree.

6. Move base of ladder toward or away from tree slightly in order to make Platform as parallel to the ground as possible.
Apply your full weight to the first step so it settles into the ground.



WARNING
DO NOT climb ladder without stabilizer bar installed. Serious injury or death may occur if stabilizer bar is not installed.

WARNING
Stabilizer Bar and Installation Straps **MUST** be secured prior to climbing the Ladderstand. Failure to comply may result in serious injury or death.

NOTE: Drawings are for illustration purposes only and may not depict actual product.

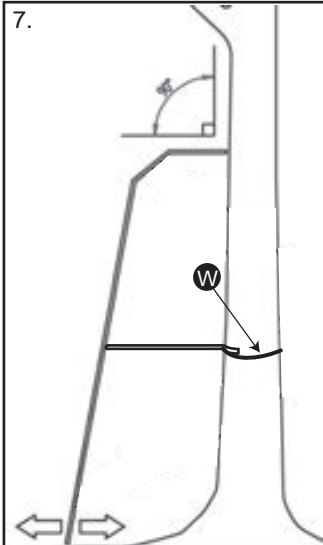

7. Tie one end of Tiedown Rope **W** to the inner part of Stabilizer Bar near the flanged end. Wrap the rope around the back of the tree once. Then tie the other end of the rope to the stabilizer bar.

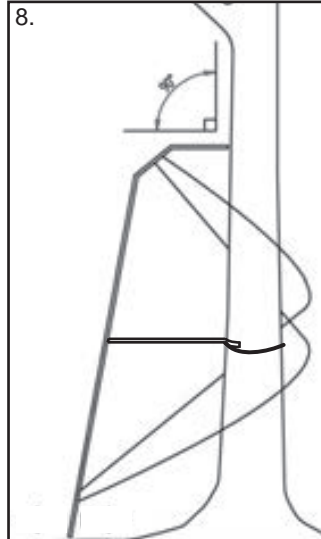

8. Cross Installation Straps behind tree. Attach to the top rung of the bottom ladder section. **(See Installation Strap Instructions)**



9. After the ladder stand has been secured to the tree with the installation straps, and the stabilizer bar has been securely attached to the tree, continue to have two people hold the ladder, climb cautiously up to the platform. Once you reach the top, **IMMEDIATELY ATTACH YOUR SAFETY HARNESS TO THE TREE.** Keep the tether strap above your head.

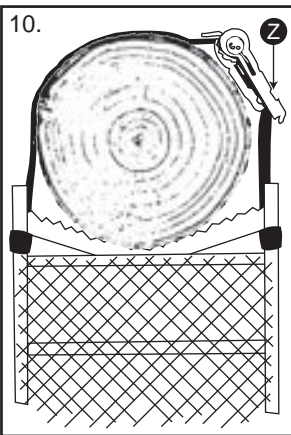

10. Cautiously climb to the top of the treestand. Wrap the strap of the ratchet around the back of the tree once and thread through the ratchet. **(See Detailed Ratchet Instructions Below)**

⚠ WARNING

Stabilizer Bar and Installation Straps **MUST** be secured prior to climbing the Ladderstand. Failure to comply may result in serious injury or death.

⚠ WARNING

DO NOT climb ladder without stabilizer bar installed. Serious injury or death may occur if stabilizer bar is not installed.

DETAILED RATCHET STRAP INSTRUCTIONS

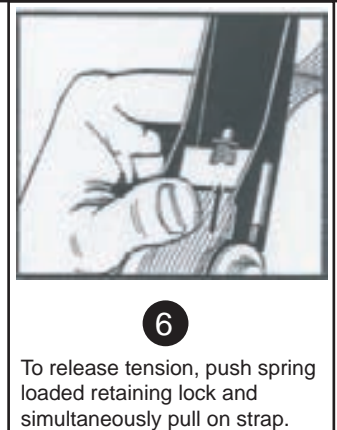
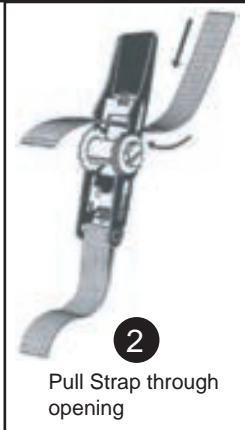

Distributed by Primal Vantage Company Inc. 685 Route 10 Randolph, NJ 07869

⚠ WARNING DO NOT sit on seat platform until the ratchet has been secured.

©2012 (rev. 03/12)

INSTALLATION STRAP INSTRUCTIONS



1. Place looped end of strap under platform.

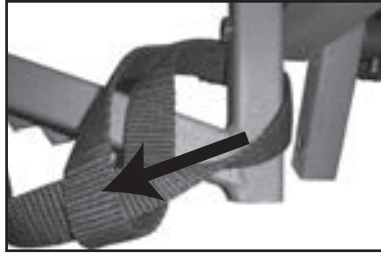

2. Insert loose end of strap through the loop.

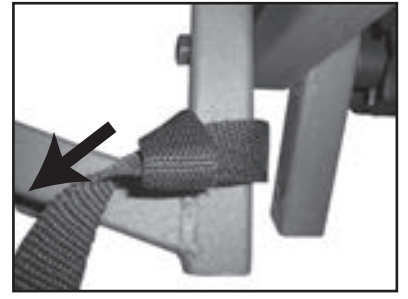

3. Pull to tighten. Continue with these steps to install the other strap on the other side of the platform.

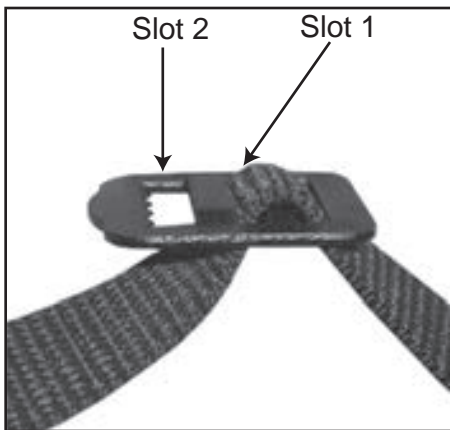

4. Place loose end of strap with clip, under the top rung of the bottom ladder section.

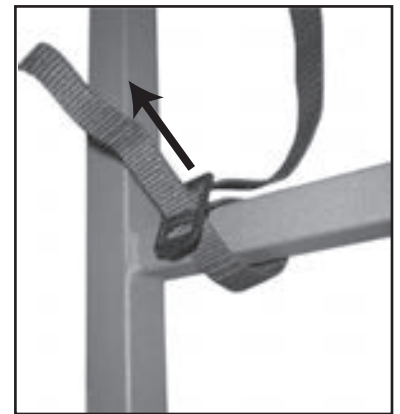

5. Insert the strap through Slot 1 on the clip.

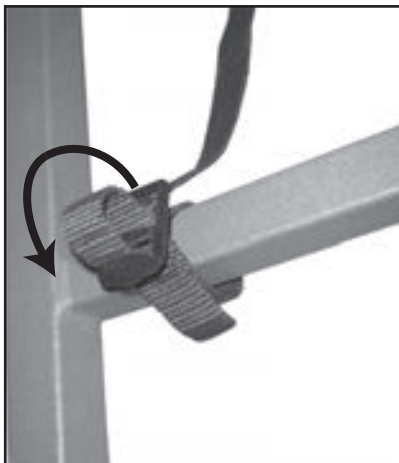

6. Insert the strap through the Slot 2 with the teeth.

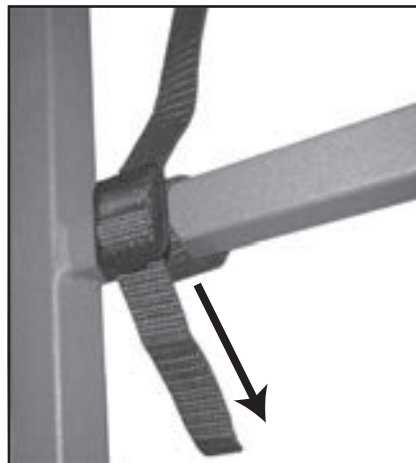

7. Pull strap to tighten.

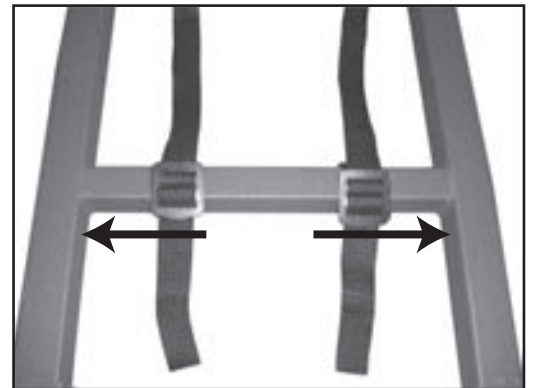

8. Slide the buckles out to the sides to create tension on the straps.

⚠ WARNING DO NOT sit on seat platform until the ratchet and installation straps have been secured.

RATCHET STRAP INSTRUCTIONS

You **MUST** follow these instructions prior to installation

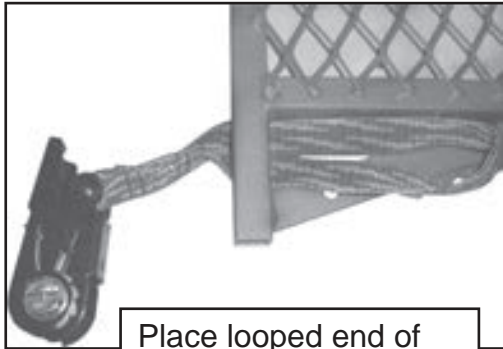

Place looped end of Ratchet under platform

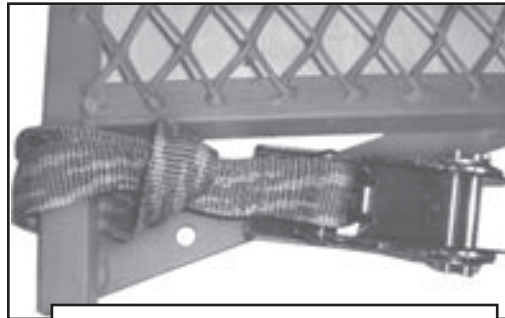

Insert ratchet through loop

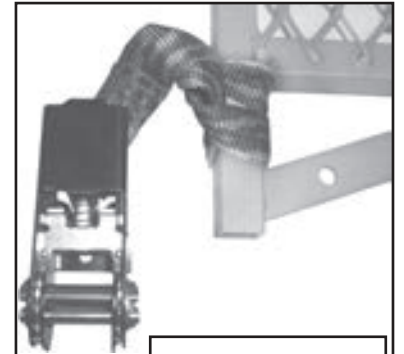

Pull to tighten



Place looped end of strap under platform

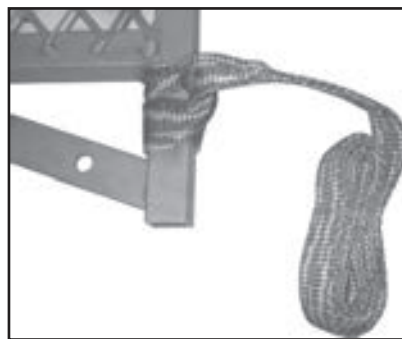

Insert strap through loop

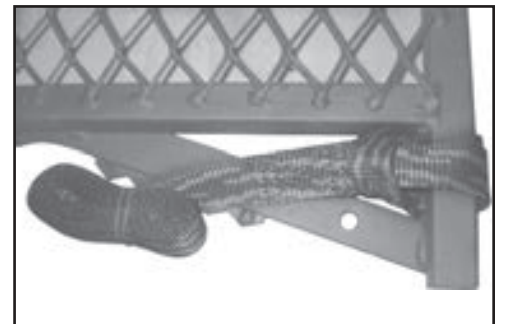

Pull to tighten

DETAILED RATCHET STRAP INSTRUCTIONS



1

Open ratchet handle flat and insert end of strap through opening.



2

Pull Strap through opening



3

Insert end of strap through slot in ratchet wheel.



4

Ratchet handle back and forth to tighten strap



5

After strap is tight, close handle to the locked position



6

To release tension, push spring loaded retaining lock and simultaneously pull on strap.



WARNING

Failure to follow all warnings listed below could result in serious injury or death.

ALWAYS read and understand all warnings and instructions before each use of this product. Failure to read and understand all warnings and instructions may result in serious injury or death.

ALWAYS inspect the tree stand for signs of wear or damage **BEFORE** each use. Also inspect to ensure that nuts and bolts are secure and straps are not frayed, worn, or broken.

DO NOT use treestand if combined weight of one person and equipment exceeds **300 lbs.** or combined weight of two people and equipment exceed **500 lbs.** **DO NOT exceed the weight limit of safety harness, refer to harness manufacturers warnings for weight limit of safety harness.**

ALWAYS wear a Fall Arrest System (FAS) after leaving the ground. If you are not wearing an FAS that meets TMA standards, **DO NOT leave the ground.** Failure to wear an FAS may result in serious injury or death.

DO NOT use this tree stand while under the influence of alcohol, medication, or illegal substances. Use of tree stand while under the influence of any of these substances may result in serious injury or death.

NEVER use this tree stand if you have a history of health problems such as (*but not limited to*) heart problems, back problems, impaired vision, equilibrium impairments are afraid of heights or have been advised by a doctor not to do any strenuous activity. If you are feeling ill, nauseous, or dizzy **DO NOT** use this tree stand or If you are not physically fit, well rested and alert. Physical ailments can reduce your ability to safely install, utilize and remove your tree stand.

NEVER use this tree stand during inclement weather such as (but not limited to) thunderstorms, snowstorms, hurricanes, icy conditions, or high winds that could create slippery or dangerous situations.

NEVER use this tree stand on a dead, leaning, loose barked tree or on a utility pole as the tree may fall, break, or uproot and may result in serious injury or death.

NEVER leave the ground without checking every ladder section connection to ensure they are firmly connected. If ladder sections are separating, with the help of at least two other people, remove the tree stand from the tree, tighten all connections and reinstall on the tree.

Installation Straps, Ratchet Straps, Quickclips, Tiedown Ropes and Stabilizer Bars MUST be installed and secured prior to climbing tree stand. Failure to comply may result in serious injury or death.

DO NOT modify or alter your tree stand.

NEVER remove or deface warning labels.



Manufactured in the year 2012 Primal Vantage Company Inc. 685 Route 10 East, Randolph, NJ 07869 1-866-972-6168

Item #'s HEH00581, HEH00582, HEH00583, 51031/9426, 51039/9247

WARNING

DO NOT climb ladder without the stabilizer bar installed. This stabilizer bar **MUST** be correctly installed prior to use. Serious injury or death may occur if the stabilizer bar is not properly installed.